



HAL
open science

HYDRA V

Sa Comex

► **To cite this version:**

| Sa Comex. HYDRA V. COMEX. 1986. hal-04512454

HAL Id: hal-04512454

<https://hal.univ-brest.fr/hal-04512454>

Submitted on 20 Mar 2024

HAL is a multi-disciplinary open access archive for the deposit and dissemination of scientific research documents, whether they are published or not. The documents may come from teaching and research institutions in France or abroad, or from public or private research centers.

L'archive ouverte pluridisciplinaire **HAL**, est destinée au dépôt et à la diffusion de documents scientifiques de niveau recherche, publiés ou non, émanant des établissements d'enseignement et de recherche français ou étrangers, des laboratoires publics ou privés.



Distributed under a Creative Commons Attribution - NonCommercial - NoDerivatives 4.0 International License

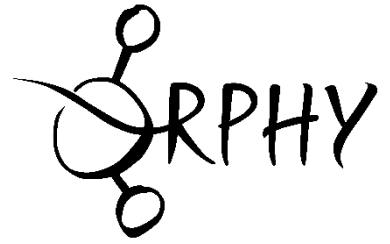

The present document is the property of COMEX SAS. It has been entrusted to the ORPHY laboratory, which scanned and uploaded it.

COMEX (Compagnie Maritime d'Expertises), established in 1962, has positioned itself in the offshore activities sector, where it held a leading international position, becoming the world's foremost company in engineering, technology, and human or robotic underwater interventions. Comex designed a Hyperbaric Testing Center in 1969 and developed its own research programs on various breathing mixtures used in deep-sea diving (helium and later hydrogen). These research efforts led to spectacular advancements in this field, including several world records, both in real conditions and simulations. Comex still holds the world record at -701 meters, achieved in its chambers during Operation HYDRA 10.

The ORPHY laboratory focuses on major physiological functions, their regulation, interactions, and their contribution to the development and prevention of certain pathologies. The primary mechanisms studied involve metabolic aspects (oxygen transport and utilization, energetics, etc.) and electrophysiological aspects (contractility and excitability), mainly related to respiratory, vascular, and/or muscular functions. These mechanisms are studied under various physiological and physiopathological conditions, ranging from the cellular and subcellular levels to the entire organism. In Europe, the ORPHY laboratory is one of the leaders in hyperbaric physiology and diving research.

Being a major player in innovation and expertise in the field of pressure, COMEX maintains a scientific archive from its experimental diving campaigns. The value of this archive is both scientific and historical, as it documents a remarkable chapter in the history of marine exploration and contains results obtained during dives that are very unlikely to be replicated in the future.

« THIS DOCUMENT IS THE PROPERTY OF COMEX, all information contained herein may neither be reproduced, used, disclosed, transmitted nor in any way made public without the written permission of the owner, any person in possession of this document acknowledges being bound by the obligation to treat it as confidential. »

. H Y D R A V

C O M E X
S C I E N T I F I C M A N A G E M E N T

MARCH 1986

CONTENTS

1. INTRODUCTION
2. HYDROGEN : PRELIMINARY STUDY AND ADAPTATION OF HYPERBARIC FACILITIES
3. ORGANIZATION : METHODS AND PROCEDURE - SCHEDULE OF THE DIVE
4. MEDICAL AND PSYCHOPHYSIOLOGICAL ASPECTS
5. NEUROPHYSIOLOGY
6. PSYCHOMETRY
7. RESPIRATORY AND CARDIO-VASCULAR PHYSIOLOGY
8. RESPIRATORY PHYSIOLOGY IN WET CONDITIONS
9. ULTRASONIC DETECTION OF CIRCULATING BUBBLES
10. EVOLUTION OF THE BIOLOGICAL PARAMETERS
11. PULMONARY AND BONE SCINTISCANNER EXAMINATION
12. SECONDARY STUDIES : VISION AND OLFACTION
13. SUMMARY AND CONCLUSION

INTRODUCTION

X. FRUCTUS

Direction Scientifique, COMEX - Marseille

A - THE NEEDS OF THE OIL INDUSTRY

During the 70's industrial diving progressed into the 150-200 meter range, which is the present depth of numerous offshore oil fields throughout the world.

But since 1983 divers have been operating regularly in the 200-300 meter range - in Brazil, for instance, where in 1984-85 COMEX divers performed more than 600 man hours of work at depths between 280 and 307 meters .

At present a number of projects (North Sea, Brazil) are aiming at even greater depths, from 300 to 450 meters.

This expansion amply justifies the program on physiological investigation of human beings in hyperbaric conditions undertaken by COMEX and the FRENCH MARINE, in particular with the series of real dives (JANUS IV, Phase 3) or simulated dives (ENTEX 5, 8 and 9) which focussed, from 1976 on, precisely on the latter depth, 450 meters.

Since 1968 when the scientific team of COMEX demonstrated and described the High Pressure Nervous Syndrome (HPNS) one of the primary goals has been to reduce this phenomenon which limits human activity at great depths.

This has been partly achieved by procedural artifices, more, perhaps, than by the use of trimix, a breathing mixture of helium and oxygen with a small percentage of nitrogen. Unfortunately trimix only accentuates the other limiting factor of high pressure - the greater density of the breathing mixture which increases ventilatory resistance to a point which is incompatible with the physical work required of the diver.

Professional diving demands unflagging efforts to ensure not only the efficacy but also, and especially, the safety of the underwater worker. Two imperatives whose practical consequence is to lengthen the access time to high pressure and to reduce the working time, thereby substantially increasing the cost of deep water operations.

Yet now is the time when the development of the offshore oil sector should push beyond the depths already conquered. It was our task, therefore, to prepare the way for manned operations at 450, 500, or even 600 meters before the end of this decade.

Reducing the limiting factors mentioned above, however (HPNS and respiratory resistances), depended on existing means, which were already pretty close to their own limits. In 1982, therefore, we decided that including hydrogen, either alone or in combination, in breathing mixtures at more than 100 meters might have two quite positive effects :

- lowering HPNS,
- improving lung ventilation,

which together would be beneficial to the deep water diver, diminishing fatigue, and enhancing his comfort and safety, without increasing the cost of operations.

B - HYDROGEN

Without in any way underestimating the constraints which safety requirements impose on its use, nor the high level of technical competence its use requires it must be acknowledged that hydrogen, as a diluent, possesses specific properties whose advantages are complementary, rather than contrary, to one another, i.e. :

- first of all, its molecular weight, the lowest of all on Mendeleiev's chart;
- next, a narcotic power (possibly anti-HPNS) less than that of nitrogen, but far greater than that of helium;
- finally, an advantageous price.

Hydrogen can not be considered as a chemically inert gas - nor can nitrogen, for that matter. Helium alone, is the most inert of all gases.

It may be worth while to note here a few points of comparison of these three gases

Physical properties	He	H ₂	N ₂
Density (g.l ⁻¹)	0.178	0.090	1.251
Thermal conductivity (W. (m. °C) ⁻¹)	34.07	40.21	5.61
Cohesive force constant (Van der Waals)	0.034	0.244	1.390
Solubility in oil at 37°C (ml.l ⁻¹)	15	40	67
Oil/water separation coefficient	1.7	3.1	5.25
Absolute viscosity (poise .10 ⁻⁵)	18.9	8.5	16,7
Narcotic power (Brauer classification)	0.07	0.26	1

C - HISTORICAL BACKGROUND

Initiated by Lavoisier in 1789, the history of hydrogen as breathable gas in a mixture was demonstrated by Zetterström a century and a half later when, in 1943-44, the Swedish naval officer dove on hydrox to sea depths of 40, 70, 110 and 160 meters without any discomfort. The death of this unfortunate pioneer at the end of the sixth trial was due to blow-up caused by a runaway winch which was raising the platform on which Zetterström was installed.

Systematic research into the biological effects of hydrogen began in the United States and France toward the end of the 60's and continued, at COMEX, until 1970.

In the United States Brauer exposed mice and squirrel monkeys to a trimix of $\text{He}/\text{H}_2/\text{O}_2$, in 1966-68, for periods up to 24 hours long at pressures of 60 to 90 ATA. The saturation was perfectly well tolerated by the animals. Peter O. Edel and five other volunteers breathed hydrox in a hyperbaric chamber at 60 meters' depth without the least difficulty. During the 70's Edel continued his research with William P. Fife, experimenting on dogs (a total of 1140 hrs of hydrox exposure at 305 m) rats and mice (5313 hours) and on themselves, in a chamber at 91 meters for 4 hours 37 minutes in all. Fife's report, well substantiated by biochemical and histological examinations on dogs, concluded that hydrox (97/3) was innocuous for animals at depths down to 300 meters and periods up to 48 hours.

In France, animal experimentation was begun in 1969 on rabbits by J. Chouteau, L. Barthélémy and A. Michaud of GERS (FRENCH NAVY) and on *Papio papio* baboons at COMEX at depths of between 300 and 675 meters (HYDRA II).

The Swedish Scientists Ornhagen, Lundgren and Muren demonstrated in 1979 that hydrogen was not at all harmful to rabbits. Twelve animals were exposed several times for 24 to 48 hours to 30 atm of hydrox ($\text{PiO}_2 = 0.2$ to 0.56 bar), and all 12 survived normally without the slightest sign of acute or chronic intoxication.

The fact remains, however, that at the start of the 80's, for what were chiefly technical reasons, experimental hydrox dives involving human beings had not gone beyond Zetterström's 160 meter depth, so that an entire realm of human physiology had yet to be explored by means of hydrogen-mix dives.

In 1983, after completing a final toxicological investigation on 30 mice exposed to 60 bars of hydrogen for 40 hours, which substantiated the harmlessness of this PH_2 , we decided to resume experimental human dives using hydrogen mixtures.

This experimental series, HYDRA III, IV and V, was carried out in the two years from June 1983 to June 1985.

HYDRA III : sea dives

From June 27 to July 4, 1983, sixteen COMEX divers in eight pairs breathed hydrox in a wet bell for five minutes at 70-73 meters. The descent and ascent were carried out with the divers breathing heliox 80/20. None of them found that hydrox tasted differently than heliox!!

On July 1, 1983, H.G. Delauze and J.P. Bargiarelli followed the same procedure but to 91 meters, each breathing hydrox for 5 minutes. The decompression, following a conservative profile with hyperoxic mixtures from 18 m on, took three hours and a half.

This first positive experience using hydrox in operating conditions encouraged us to undertake the next experiment, HYDRA IV.

D - HYDRA IV

In this experiment, conducted in November of 1983, six divers were saturated on heliox to 300 meters with hydrox exposures of from one to several hours at depths between 120 and 300 m. These tests confirmed the breathing comfort and attenuation of muscular fatigue afforded by hydrogen. They also made it possible to establish, for the first time on human beings, an evaluation of its particular narcotic power.

The following is a brief outline of the conclusions presented in the HYDRA IV report and the papers given at the Xth E.U.B.S. Congress in Marseilles in October 1984

1 - Hydrogen toxicity at partial pressures of 12 to 25 bars for exposures of 1 to 6 hours was not shown by the biochemical blood and urine examinations. This constitutes an initial confirmation of the results of much more severe animal experiments. For exposures of several hours, at 15 bars, at least, hydrogen appears to behave like an inert gas relative to cell structures, while at the same time affecting the psychic functions, as does of course our old friend nitrogen at even lower pressures.

2 - The conditions of this first physiological attempt were not such as to permit exhaustive respiratory function investigations. And while the divers were able to appreciate the breathing comfort they qualified as "extraordinary" on hydrox, as well as the lack of tiredness during exercise, the results of the measurements taken in the difficult conditions of immersion are more delicate to interpret.

Examination of the heart rates measured during exercise, however, tends to indicate a lower cost of the heart of exertion on a hydrogen mixture.

3 - According to the work published by Lambertsen and by d'Aoust, switching the divers from the experimental hydrox to their storage gas heliox should have produced the inert gas phenomenon of isobaric counterdiffusion, with the formation of circulating or stationary bubbles. During HYDRA IV Doppler detection echography both confirmed the existence of this bubble-producing mechanism. Under the conditions of this experiment the phenomenon did not have any pathological consequences, but it will bear watching in subjects saturated at greater depths.

4 - Certain aspects of hydrogen narcosis are different from those of air narcosis, at least in the initial phases. The difference in intensity of the phenomena can be evaluated, however, the hallucinant power of hydrogen being about one-fourth that of nitrogen.

In any event the results of HYDRA IV enabled us to maintain that its narcotic potency - controllable because it depends on the PH_2 - indicates the use of hydrogen mixes since :

- for one thing it depends on the ambient pressure, which has a counter effect on the narcotic action of the gas (or a "pressure reversal effect", as the Anglo-Saxons call it).

- for another thing the narcotic power itself has a contereffect on the high pressure nervous syndrome, like nitrogen - which would be a definite advantage for dives beyond 300 meters.

E - THE OBJECTIVES OF HYDRA V

The purposes of the next hydrox tests are obvious :

- on the technical level, to constitute a hyperbaric system which could be pressurized with hydrogen as well as helium and which comprised a new ECS capable of controlling not only temperature and relative humidity at all times, but also the PIO_2 by automatic O_2 injection in the hydrogen mixture.
- on the physiological level, confirmation of the anti-HPNS effect of hydrogen, which would, moreover, increase the diver's work capability both in the dry and in the wet. And this under pressure conditions (46 ATA) following a 38-hour compression, identical to those of the preceding dives, ENIEX 5, 8 and 9, on helium or nitrogen trimix.

Operation HYDRA V was long enough to permit a number of physiological investigations, of which the chief ones were :

- regular blood and urine analyses in order to detect any incipient toxicity, albeit unlikely, of hydrogen during prolonged exposure;
- regular EEG checks and tremor measurement;
- respiratory function investigation during rest and work periods, both in the dry and in the wet;
- medical surveillance and observation of behavior;
- study of isobaric counterdiffusion phenomena when switching from hydrox to heliox, and consequently determining what is feasible or prohibited in transferring from one gas to another;
- plus, of course the final decompression of team B on hydrogen mix up to 200 meters for which we had to establish a profile without benefit of previous experience, since no-one had ever before "come up" from a 450-meter saturation on hydrox.

HYDRA V

HYDROGEN : PRELIMINARY STUDY AND ADAPTATION OF HYPERBARIC FACILITIES

C. GORTAN
Hyperbaric Experimental Center
COMEX, Marseilles

« THIS DOCUMENT IS THE PROPERTY OF COMEX, all information contained herein may neither be reproduced, used, disclosed, transmitted nor in any way made public without the written permission of the owner, any person in possession of this document acknowledges being bound by the obligation to treat it as confidential».

C O N T E N T S

1. INTRODUCTION

2. HYDROGEN AND FLAMMABILITY RISKS
 - 2.1 Experimental set-up
 - 2.2 Experimental protocol
 - 2.3 Tests
 - 2.4 Results

3. COMPATIBILITY OF MATERIAL WITH HYDROGEN

4. PURITY OF HYDROGEN

5. ADAPTATION OF HYPERBARIC FACILITIES
 - 5.1 Saturation chambers
 - 5.2 Hydrogenated gas regeneration system
 - 5.3 Gas circuits

6. SAFETY DEVICES

7. OPERATING THE EQUIPMENT

8. CONCLUSIONS

1 - INTRODUCTION

The use of hydrogen for human experimental deep diving was decided upon after imposing safety as the main technical aim.

The HYDRA experiment was only carried out after the risks relating to the use of heavy equipment initially intended for containing air or inert gases were thoroughly studied.

Means, methods and procedures were defined on the basis of several self-imposed safety levels :

- Accurate knowledge of non-flammability limits of H_2 -He- O_2 ternary mixtures under hyperbaric conditions;
- Compatibility of hydrogen with the materials used for heavy equipment;
- Use of breathing quality hydrogen;
- Continuous regeneration hydrogenated respiratory gases;
- Conformability of all the gas circuits;
- Anticipation of any eventual leak in saturation equipment with detection and extraction;
- Setting up operating procedures for the equipment by anticipating and averting human error.

The fact that no significant technical mishap occurred during HYDRA V contributed to the success of the operation and proved that when simple safety rules are respected it is no more dangerous to handle hydrogen than some other gases used at high pressure for deep diving, such as oxygen.

2 - HYDROGEN AND FLAMMABILITY RISKS

Everybody knows that hydrogen is highly combustible.

The combustion process occurs from the following chemical reaction :

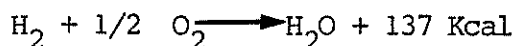

This reaction is highly exothermic and the mixture turns into an "explosive" one when the proportions become stoichiometric .

Before carrying out the HYDRA IV and V experiments, we implemented experimental research regarding the flammability limits of H₂-He-O₂ trimixes under pressure. This research was necessary to accurately determine below what limits of oxygen concentration flame can no longer be propagated, whatever the H₂-He ratio may be.

2.1 - Experimental set-up

The main tool of the experiment was a cylindrical experimentation chamber with the following specifications :

- length	1000 mm
- internal diameter	80 mm
- volume	5 litres
- working pressure	600 bars
- test pressure	900 bars

Both ends of the chamber were sealed with screwed caps. One of the caps was fitted with two Souriau unipolar electric hull penetrators for ignition electrodes.

The other cap contained three gas penetrators for pressurization, analysis, and pressure measurement.

The cylindrical part of the chamber had eight hull penetrators to receive the electrodes used for measuring the propagation speed of the flame.

After the gas mixture was made up it was homogenized by a motorized system which spun the chamber around.

The ancillary equipment (data acquisition, analyses, etc.) is shown in Figure 1.

2.2 - Experimental protocol

Tests were carried out at the following pressures :

15, 30, 45, 60 and 75 bars

with hydrogen concentration of :

20, 30, 40, 50 and 60 %.

The purpose of each test was to determine the minimum oxygen concentration at which the flame was no longer propagated for each level of pressure and hydrogen concentration.

The trimix was prepared directly in the combustion chamber with hydrogen, helium and heliox (He-O_2) after creating a vacuum.

The resulting mixture was analysed by chromatography before and after ignition. Oxygen was measured a second time with a special oxygen analyzer.

Combustion was initiated by 3.16 mm \varnothing welding electrodes connected to a SAF 320 welding set. The ignition energy was very high : 50 to 300 joules for an electric arc lasting from 50 to 300 milliseconds, i.e. 1 joule per millisecond.

At each level of hydrogen concentration and pressure several tests were carried out for which the oxygen concentration varied around the assumed flammability limit.

By measuring the oxygen concentration before and after ignition, it is possible to draw the oxygen variation curve for a given pressure. The point of inflexion squares with the limit oxygen concentration below which flame can no longer be propagated (Figure 2).

This method enabled us to determine the limits quite accurately.

2.3 - Tests

The following table shows the distribution of tests as a function of pressure and hydrogen concentration.

Pressure (bars)	Total number of tests	H Y D R O G E N				
		20%	30%	40%	50%	60%
15	50	13	12	8	8	9
30	33	6	7	9	7	4
45	22	6	5	3	4	4
60	22	6	4	3	4	5
75	15	4	3	3	3	2
	142	35	31	26	26	24

In addition, a number of tests at a pressure of 1 bar were carried out to finalize the method, without being counted.

2.4 - Results

As a general rule, the limit oxygen concentration decreases :

- when the total pressure increases;
- when the concentration in diluent neutral gas (helium) increases.

Figure 3 : It should be noted that the pressure of the mixture affects the limit oxygen concentration. We can see that irrespective of the H_2 -He ratio, this limit concentration decreases when the total pressure of the H_2 -He- O_2 ternary mixture increases.

Figure 4 : On this figure the limit oxygen concentrations are expressed as a function of the hydrogen partial pressure. As can be seen, nearly all the points corresponding to the tests carried out at a total pressure of 75 bars are aligned on an asymptote at an oxygen concentration of 4.4 %.

We can also see that for the same pressure the oxygen required decreases when the H_2 /He ratio diminishes. This is probably due to the fact that the proportions approach the H_2/O_2 stoichiometric ratio. Contrary to what one might think, flammability risks do not decrease with an increase in helium concentration, in an H_2 -He- O_2 trimix.

Figure 5 : The H_2 -He- O_2 triangular diagram shows the lower flammability limits of hydrogen in a ternary mixture with helium and oxygen. At a pressure of several bars the mixture only becomes flammable with a minimum hydrogen concentration of 7.5 % on the condition that the oxygen concentration is sufficient.

On the basis of these results, we have established rules for the use of hydrogen in saturation experimental deep diving :

- Compression phase

Hydrogen is injected when the oxygen concentration falls below 2 %, i.e. at a minimum depth of 200 meters.

- Decompression phase

Hydrogen is progressively eliminated to ensure a concentration lower than 3 % upon arrival at 200 meters.

These rules ensure a very wide safety margin

THIS DOCUMENT IS THE PROPERTY OF COMEX, all information contained herein may neither be reproduced, used, disclosed, transmitted nor in any way made public without the written permission of the owner, any person in possession of this document acknowledges being bound by the obligation to treat it as confidential.

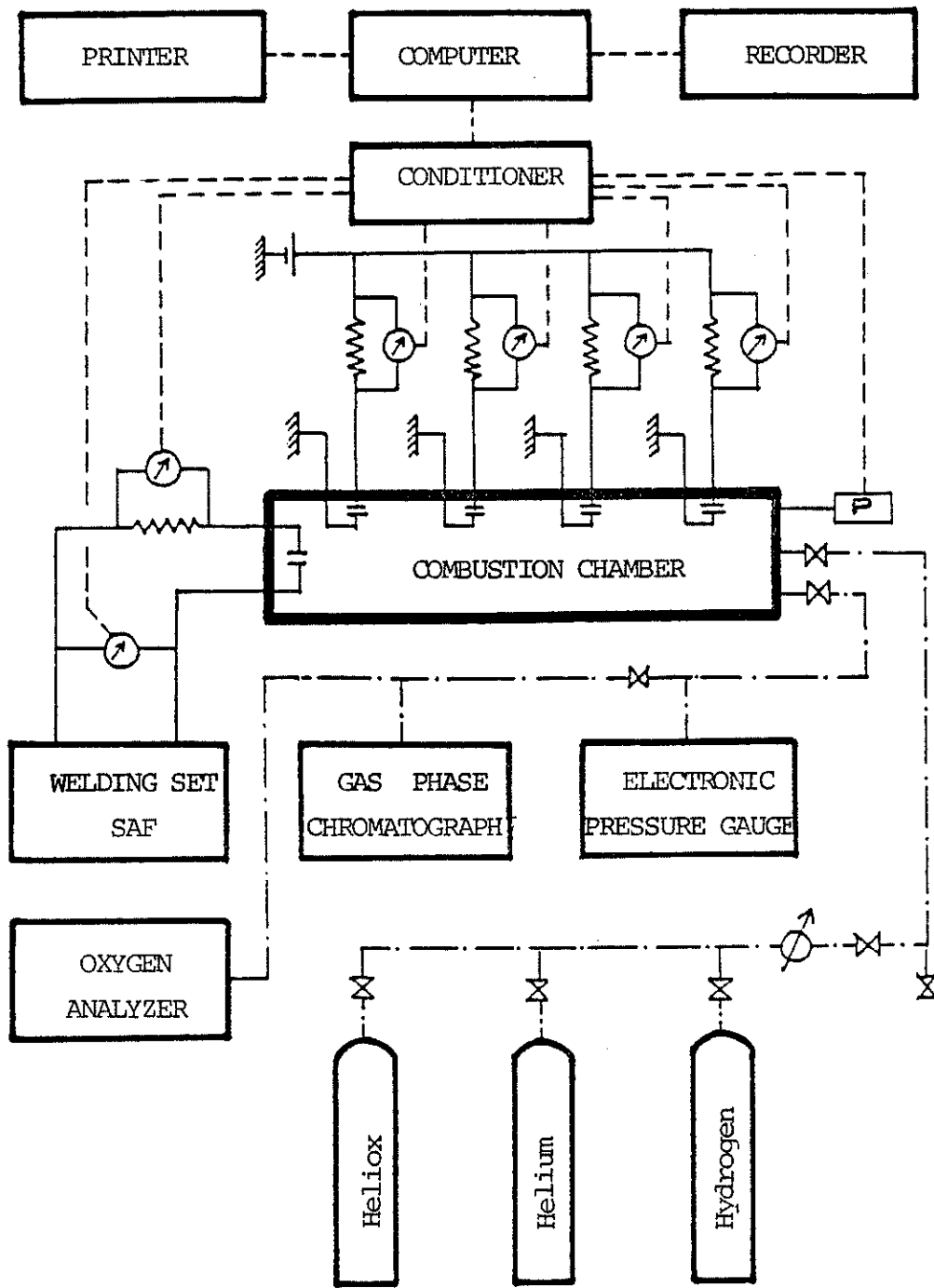

Figure 1 : Circuit diagram of experimental set-up

HYDRA V - RESEARCH ON THE FLAMMABILITY LIMITS OF HYDROGEN

$$\frac{\% O_2 f}{\% O_2 i}$$

Figure 2 : Research on oxygen limits

HYDRA V - RESEARCH ON FLAMMABILITY LIMITS OF HYDROGEN

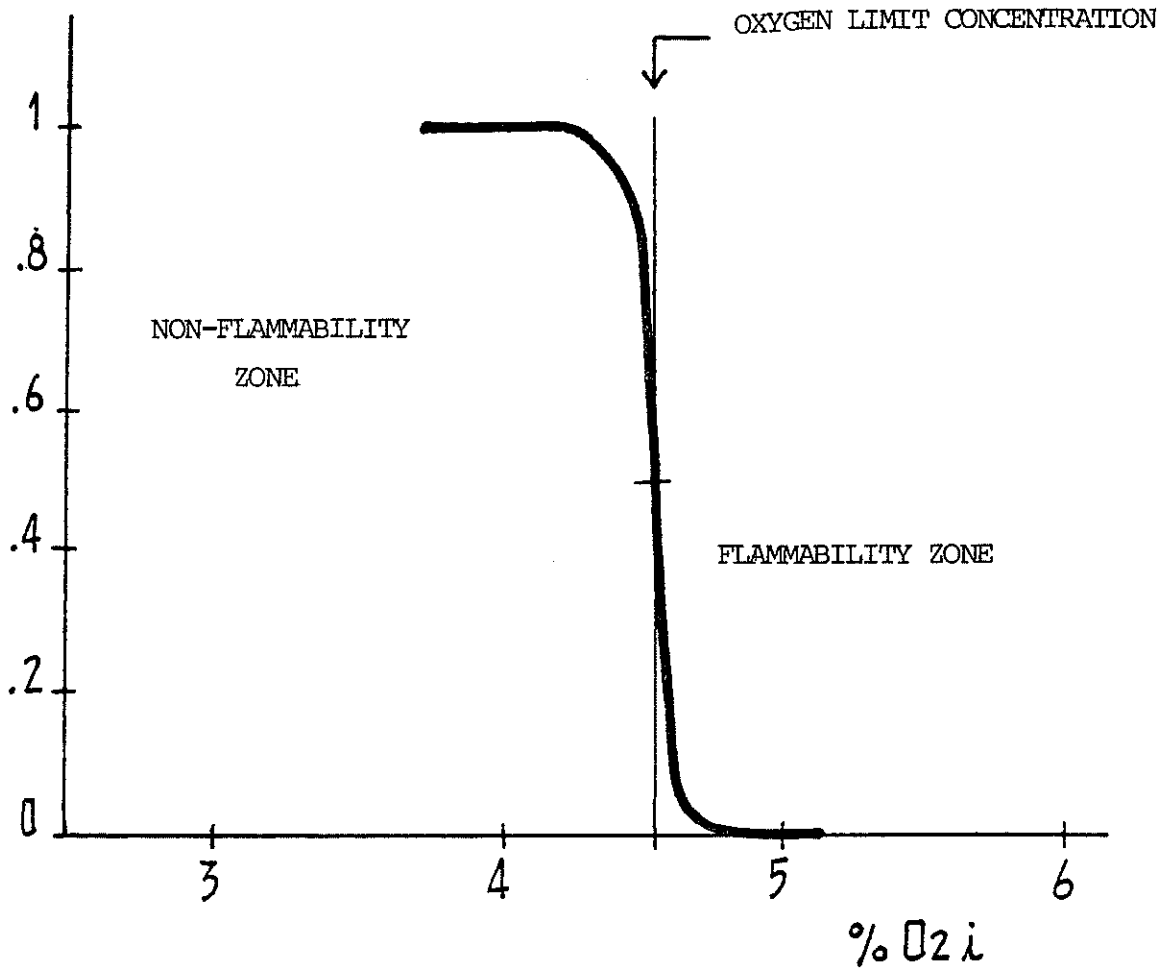
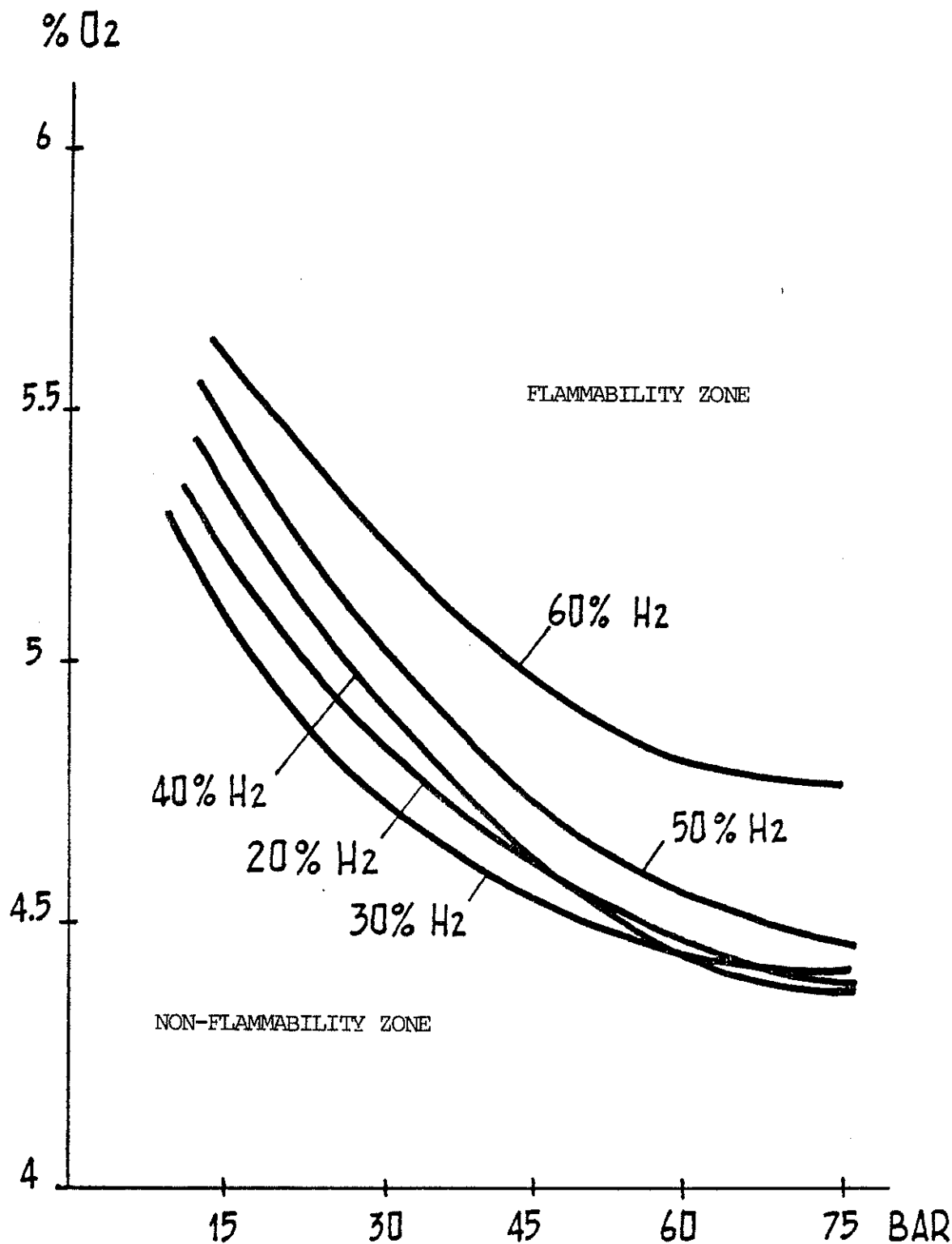

Figure 3 : EVOLUTION OF THE LIMIT CONCENTRATION OF OXYGEN
AS A FUNCTION OF PRESSURE

HYDRA V : RESEARCH INTO THE FLAMMABILITY LIMITS OF HYDROGEN

« THIS DOCUMENT IS THE PROPERTY OF COMEX, all information contained herein may neither be reproduced, used, disclosed, transmitted nor in any way made public without the written permission of the owner. any person in possession of this document acknowledges being bound by the obligation to treat it as confidential. »

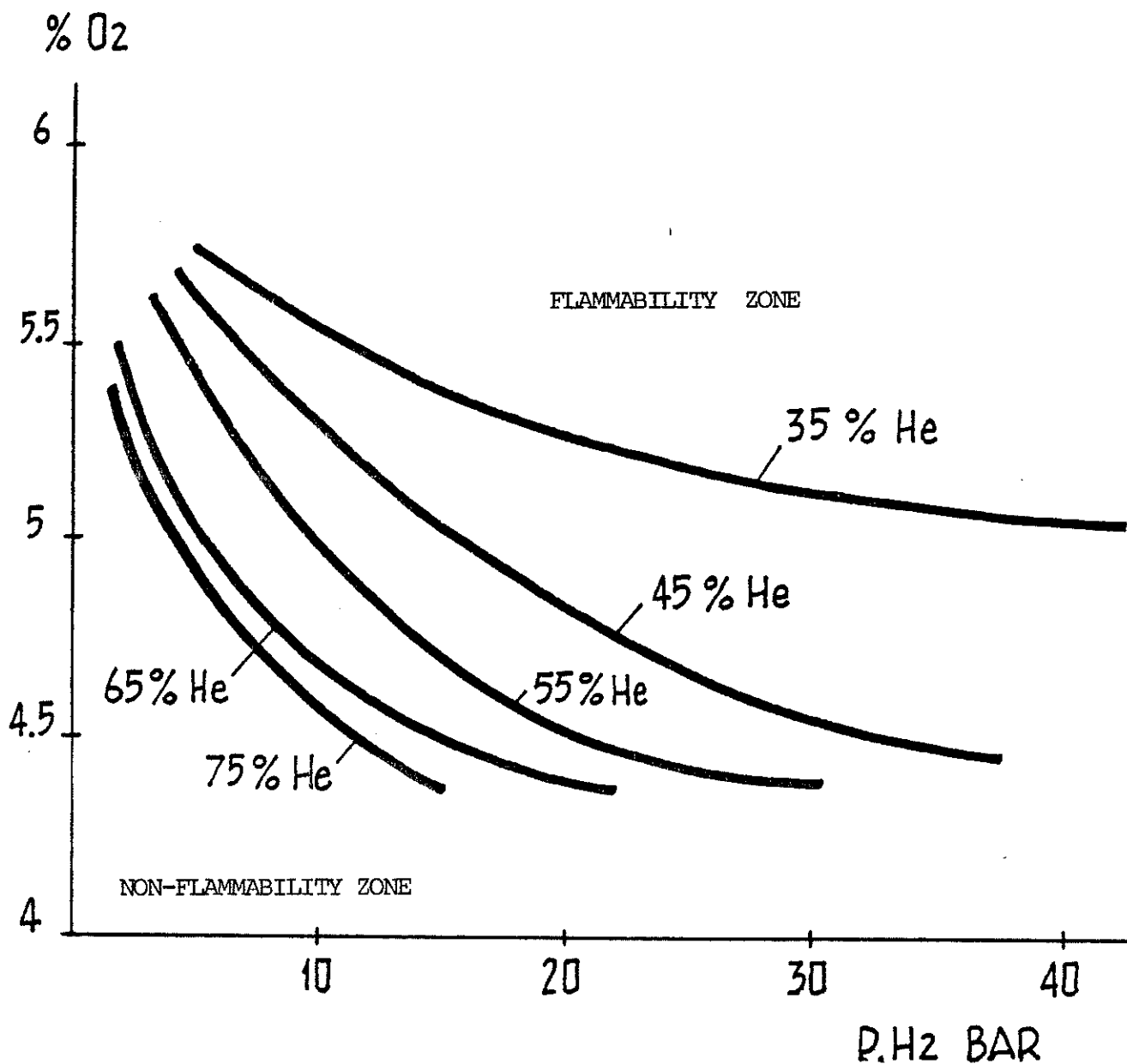

Figure 4 : THE INFLUENCE OF HELIUM CONTENT

HYDRA V : RESEARCH ON THE FLAMMABILITY LIMITS OF HYDROGEN

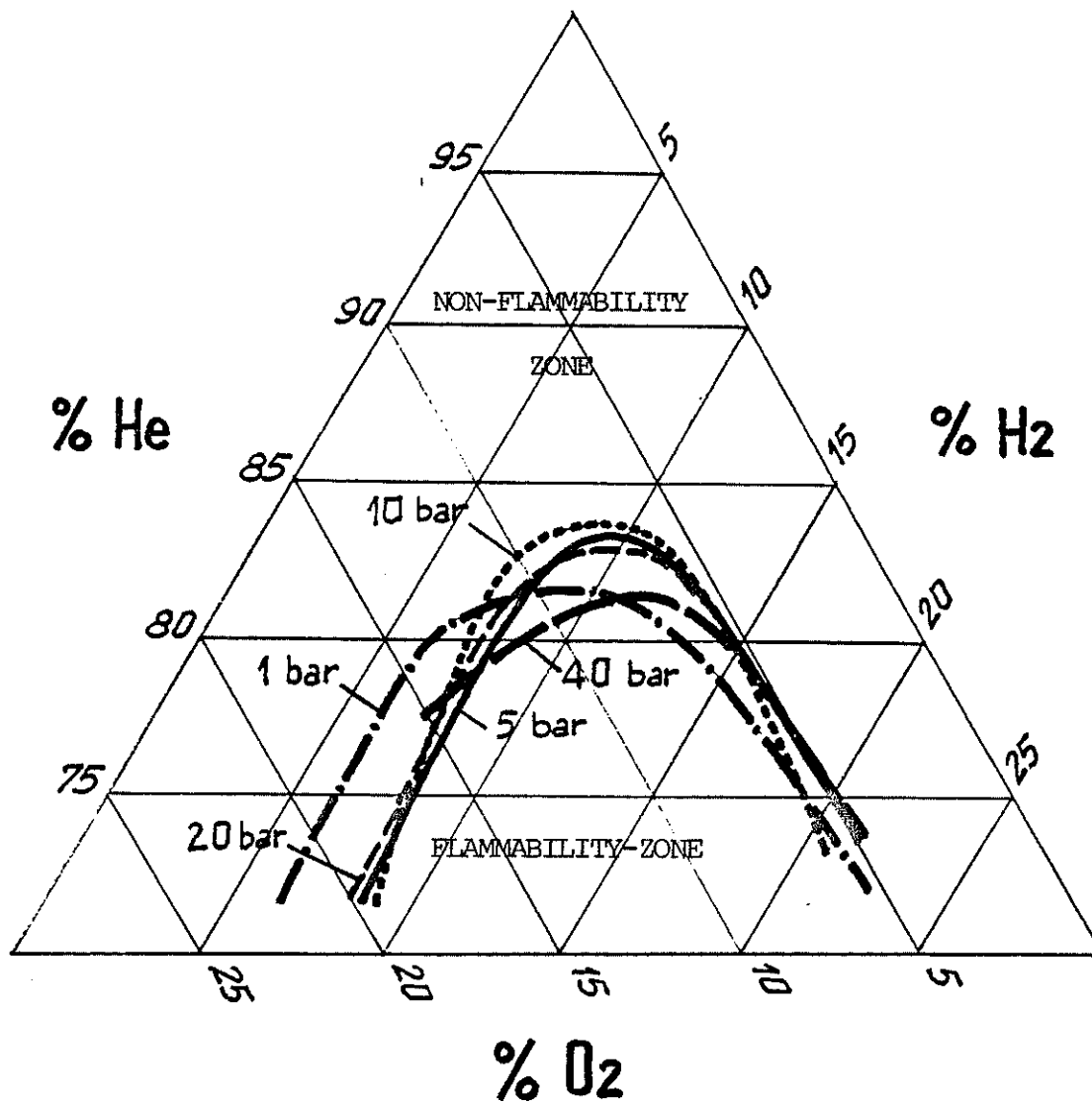

Figure 5 : Lower flammability limits

HYDRA V : RESEARCH ON THE FLAMMABILITY LIMITS OF HYDROGEN

« THIS DOCUMENT IS THE PROPERTY OF COMEX, all information contained herein may neither be reproduced, used, disclosed, transmitted nor in any way made public without the written permission of the owner, any person in possession of this document acknowledges being bound by the obligation to treat it as confidential. »

3 - COMPATIBILITY OF METALS WITH HYDROGEN

The phenomenon of hydrogen embrittlement of steel has been widely studied.

Many works have shown that the presence of certain elements in hydrogen inhibits its embrittlement effect. This is particularly the case with oxygen, which at a minimum quantity of several hundred ppm, considerably limits the penetration of hydrogen into metal. This presumably results from a greater affinity of steel for oxygen.

G.C. HANCOCK and H.H. JOHNSON (1) have studied this phenomenon with very significant results (Figure 6). We can see that crack growth only occurs in a pure hydrogen atmosphere. As soon as hydrogen is replaced by a hydrogen-oxygen mixture, the cracking process quickly stops and stabilizes.

J. BRYSELBOUT of Air Liquide Company (2) has also proved that oxygen has an inhibiting action which increases as the oxygen concentration increases.

The oxide layer deposited on sound metal presumably acts as a hydrogen-tight barrier. Combined traces of water vapour and oxygen have a greater inhibiting effect than water vapour and oxygen separately (Figure 7).

Embrittlement is also linked to the hydrogen partial pressure and both factors evolve in the same direction (Figure 8).

As regards hydrogen saturation diving embrittlement risks will thus be considerably reduced due on the one hand to the permanent presence of oxygen and water vapour in the ambient gases of the chambers and on the other hand to the low hydrogen partial pressure.

As a matter of fact, given the results of HYDRA IV and V, the hydrogen partial pressure admissible as regards narcosis will undoubtedly be lower than 40 bars at total pressures ranging from 70 to 80 bars.

Only in the context of animal experimentation will hydrogen pressure reach and perhaps exceed 100 bars, but the presence of water vapour and oxygen will certainly inhibit the embrittlement process. As a safety measure equipment will however be regularly checked, particularly in the zones subject to high stress.

- (1) Hydrogen, oxygen and subcritical crack growth in a high strength steel - G.C. HANCOCK and H.H. JOHNSON - Transaction of the Metallurgical Society of AIME - Volume 236, April 1966, 513-516.
- (2) Influence des pressions partielles d'impuretés gazeuses sur la tenue des matériaux - J. BRYSELBOUT - Centre de Recherche Claude Delorme - Air Liquide Report 86.83 - 1983.

THIS DOCUMENT IS THE PROPERTY OF COMEX, all information contained herein is to be controlled and not to be disseminated without the written permission of the owner. Any person in possession of this document acknowledges being bound by the obligation to treat it as confidential.

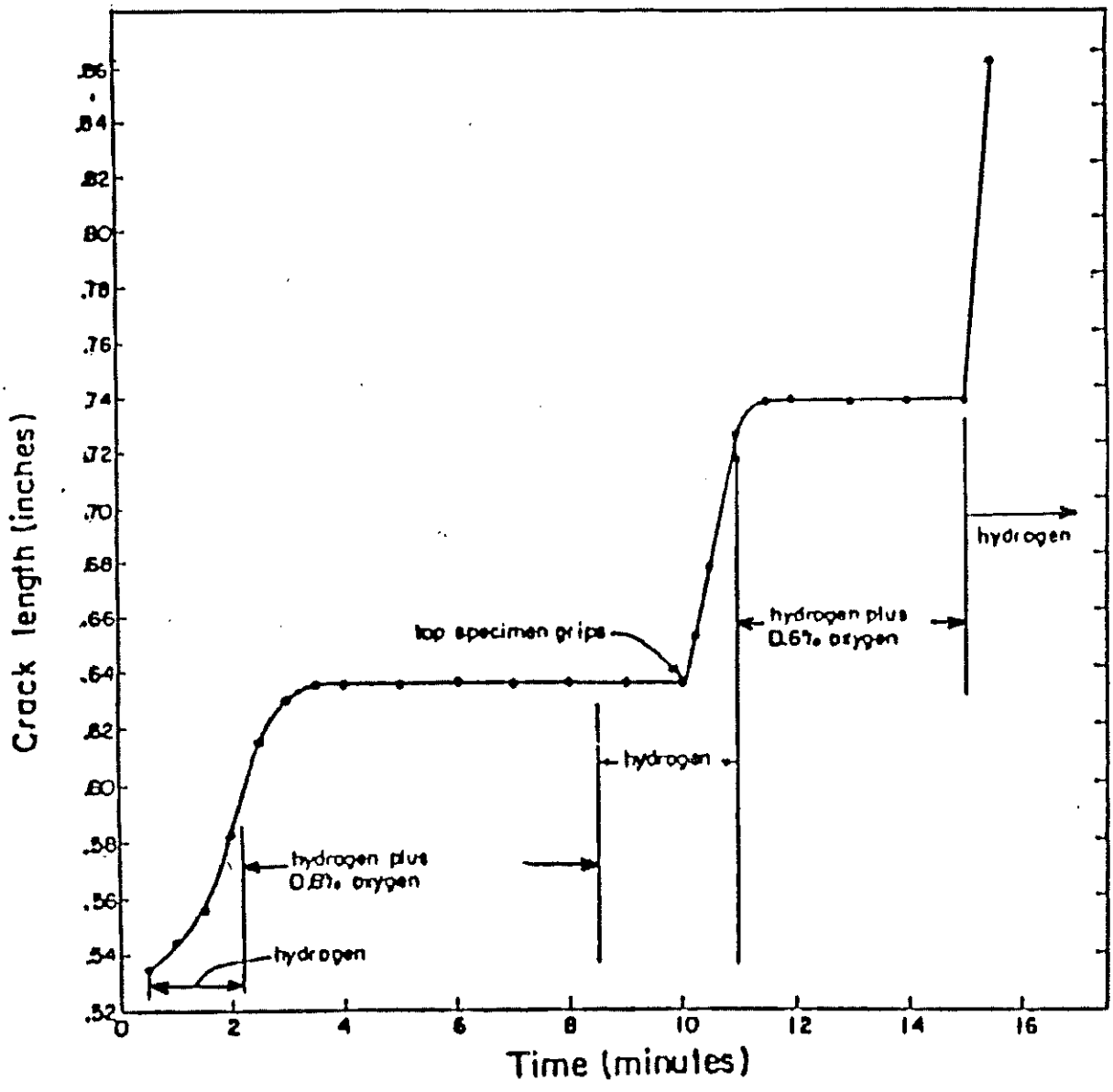

Ref. : G.C. Hancock
& H.H. Johnson (1)

Figure 6 : Inhibition embrittlement by oxygen

« THIS DOCUMENT IS THE PROPERTY OF COMEX, all information contained herein may neither be reproduced, used, disclosed, transmitted nor in any way made public without the written permission of the owner, any person in possession of this document acknowledges being bound by the obligation to treat it as confidential ».

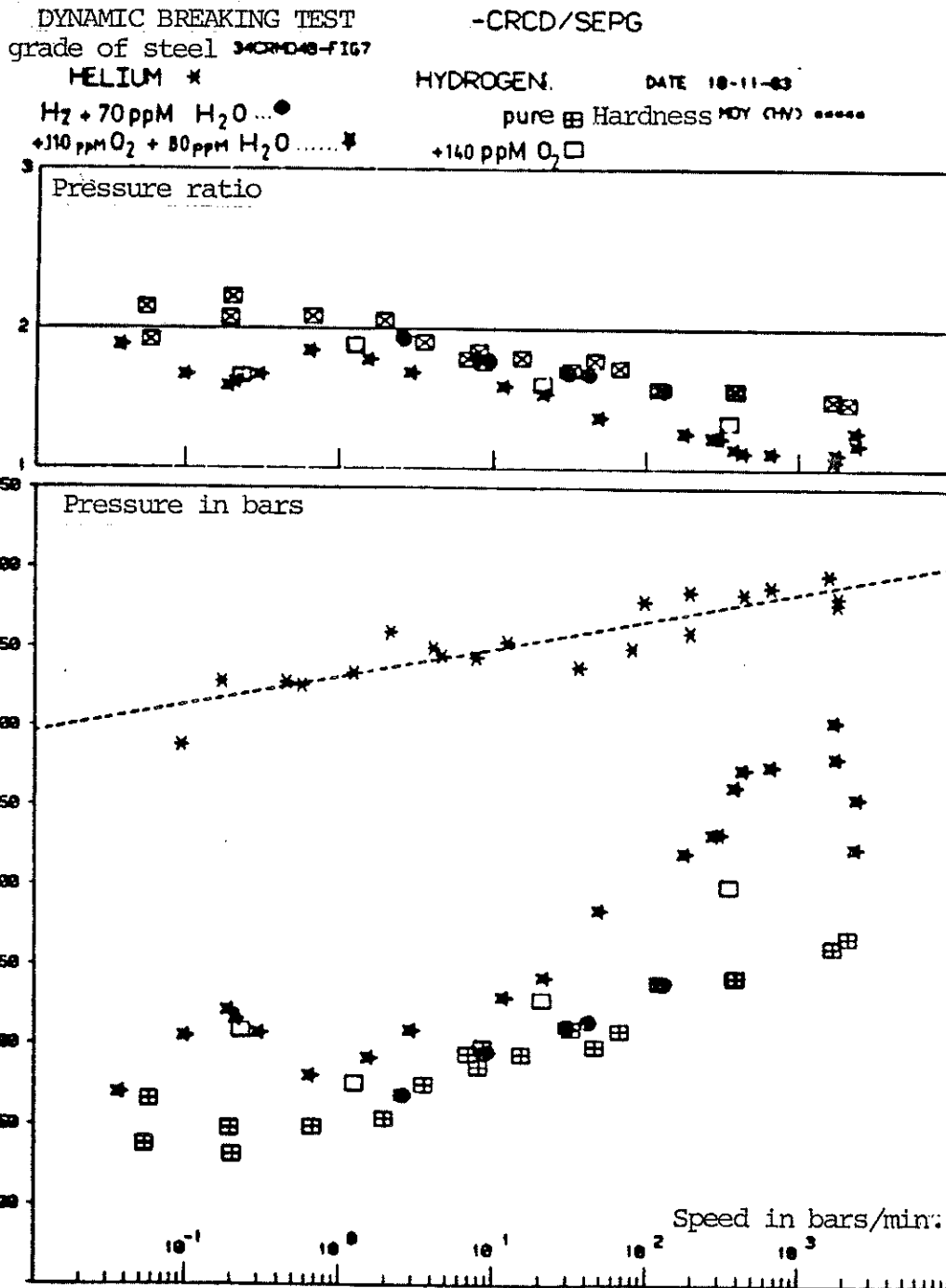
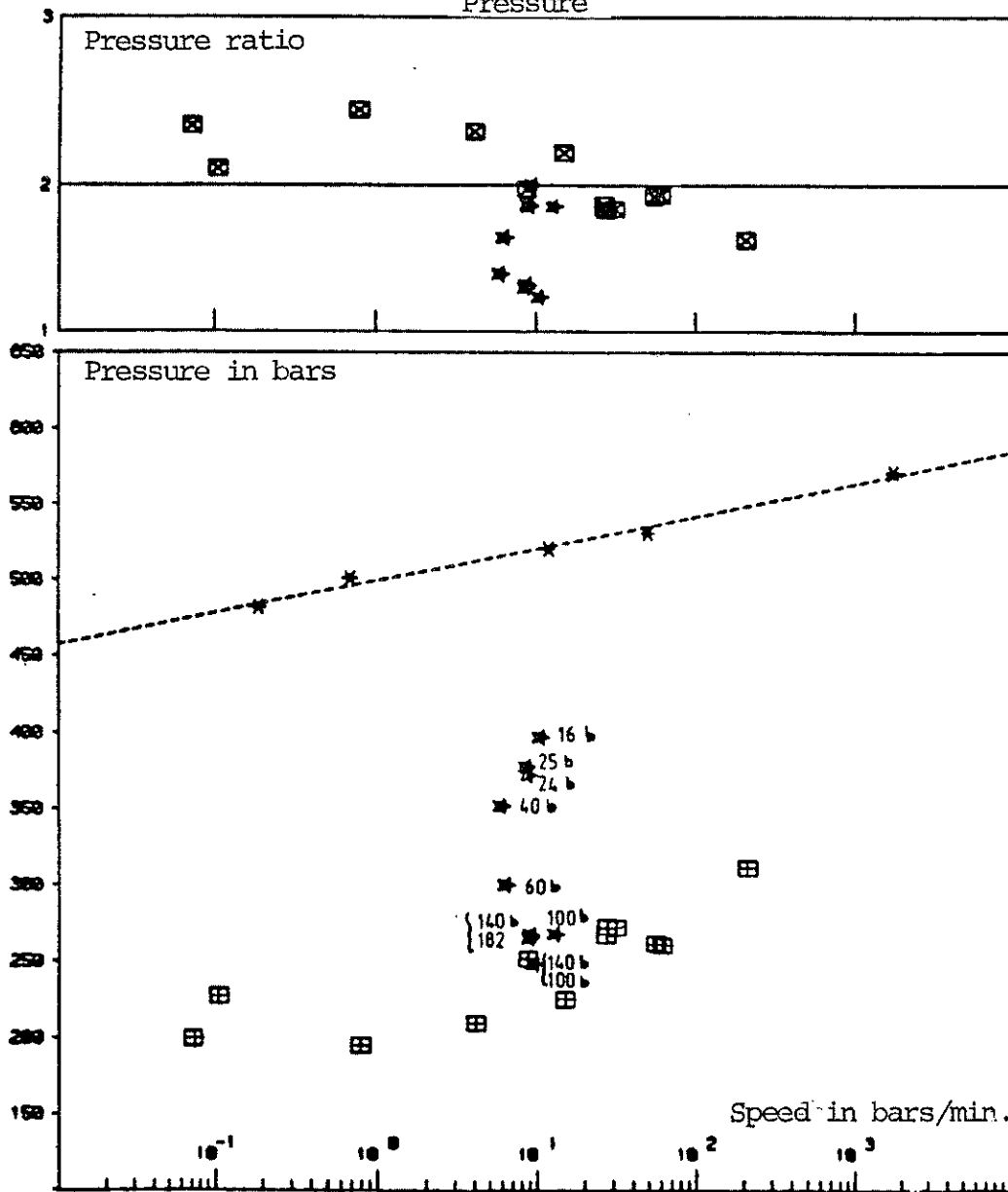

Figure 7 : Influence of oxygen and water vapour on embrittlement of steel by hydrogen

DYNAMIC BREAKING TEST - CRCD/SEPG
 grade of steel 35004-2 Figure 10
 HELIUM * HYDROGENE □ DATE 9-11-83
 Partial Pressure * Hardness MOY (HV) 350 ± 4



Ref : J. Bryselbout (2)

Figure 8 : Influence of hydrogen partial pressure on embrittlement

« THIS DOCUMENT IS THE PROPERTY OF COMEX, all information contained herein may neither be reproduced, used, disclosed, transmitted nor in any way made public without the written permission of the owner, any person in possession of this document acknowledges being bound by the obligation to treat it as confidential. »

4 - HYDROGEN PURITY

The hydrogen proposed by the two main gas suppliers is either of catalytic or of electrolytic origin.

Most people in the profession considered that electrolytic hydrogen offered the best warranties as regards breathing quality. As a matter of fact this type of hydrogen may seem purer as compared to the cracking of hydrocarbonic molecule, since it results from water electrolysis. By using catalytic hydrogen for HYDRA III, IV and V experiments we have proved that this is not a necessary condition.

The "purity grade" is not the only factor to be taken into account in choosing the ultra pure gases intended for human (or animal) breathing in a confined hyperbaric enclosure.

In our case traces of oxygen and nitrogen do not degrade the purity of the gas. But the possible presence of microtraces of various compounds likely to be salted out by the catalytic or adsorption agents used during the final scrubbing phase must be seriously taken into consideration.

As for breathing quality, hydrogen concentrations of metallic hydrides will have to be particularly well checked.

It goes without saying that cryogenic adsorption on a molecular sieve is the best hydrogen scrubbing method. Metallic hydrides are completely trapped at the temperature of liquid nitrogen.

We had set the following specifications for HYDRA V :

Purity	> 99.98 %
Special treatment	Cryogenic scrubbing
O ₂	< 100 ppm
N ₂	< 100 ppm
CO	< 0.5 ppm
CO ₂	< 5 ppm
CH ₄	< 5 ppm
Metallic hydrides	< 0.0015 ppm expressed in AsH ₃ , PH ₃ , and HCN.

For metallic hydrides, we fixed the maximum acceptable values at 450 meters as follows :

Arseniuretted hydrogen	0.05 microbar (AsH ₃)
Phosphuretted hydrogen	0.3 microbar (PH ₃)
Hydrogen cyanide	10 microbar (HCN)

In the H₂-He-O₂ trimix with 54 % hydrogen the above values correspond to the voluminal concentrations :

AsH ₃	0.002 ppm
PH ₃	0.012 ppm
HCN	0.4 ppm

5 - ADAPTATION OF HYPERBARIC FACILITIES

The hyperbaric facilities of the COMEX Research Center, particularly the chambers, were not initially intended for hydrogen use. We thus had to adapt them to this new deep diving technique. Activity areas in the Research Center were also redefined (Figure 9).

5.1 - Saturation chambers

In accordance with HYDRA V experimental protocol we organized two separate and distinct zones (Figure 10) :

- one zone for the unique use of hydrogenated trimixes (hydreliox)
- one zone for heliox, to be used both as a strategic retreat position in case of safety problems, and for the final decompression of the divers.

HYDRELIOX ZONE

The EMS 600 modular saturation system was chosen for the hydrogen phase of the operation. This system is made up of three interconnected spheres which can be pressurized to different levels :

- Sphere 1 : Living chamber
- Sphere 2 : Sanitary chamber and bell simulation
- Sphere 3 : Laboratory for tests in the dry or in the wet.

Internal lights were replaced by external ones fixed on the viewports and protected by thermal filters.

All the metal components were grounded.

All the o-rings on doors, viewports, locks, technical plugs and manways were replaced by seals compatible with hydrogen use. Before the first

team of divers was pressurized we made a rigorous test of system tightness at a pressure of 45 bars with hydreliox trimix.

All the rest of the internal equipment was that normally used for physiological experiments in heliox.

HELIOX ZONE

A six-person cylindrical chamber with built-in lock was connected to sphere 2 of the EMS 600 to accommodate the divers after their stay in hydrogen. Its main specifications were as follows :

- Internal diameter : 2.3 m
- Overall length : 9.3 m
- Chamber length : 6.8 m
- Lock length : 1.9 m
- Working pressure : 60 b
- Chamber volume : 27 m³
- Lock volume : 8 m³

The transfer lock, which is normally used as a sanitary chamber, can be fitted out with 2 bunks in the eventuality it should be necessary to pressurize a medical assistance team.

The physiological test equipment was identical to that used in the EMS 600, in order to carry out reference tests on heliox.

THIS DOCUMENT IS THE PROPERTY OF COMEX. All information contained here may neither be reproduced, used, disclosed, transmitted nor in any way made public without the written permission of the owner. Any person in possession of this document acknowledges being bound by the obligation to treat it as confidential.

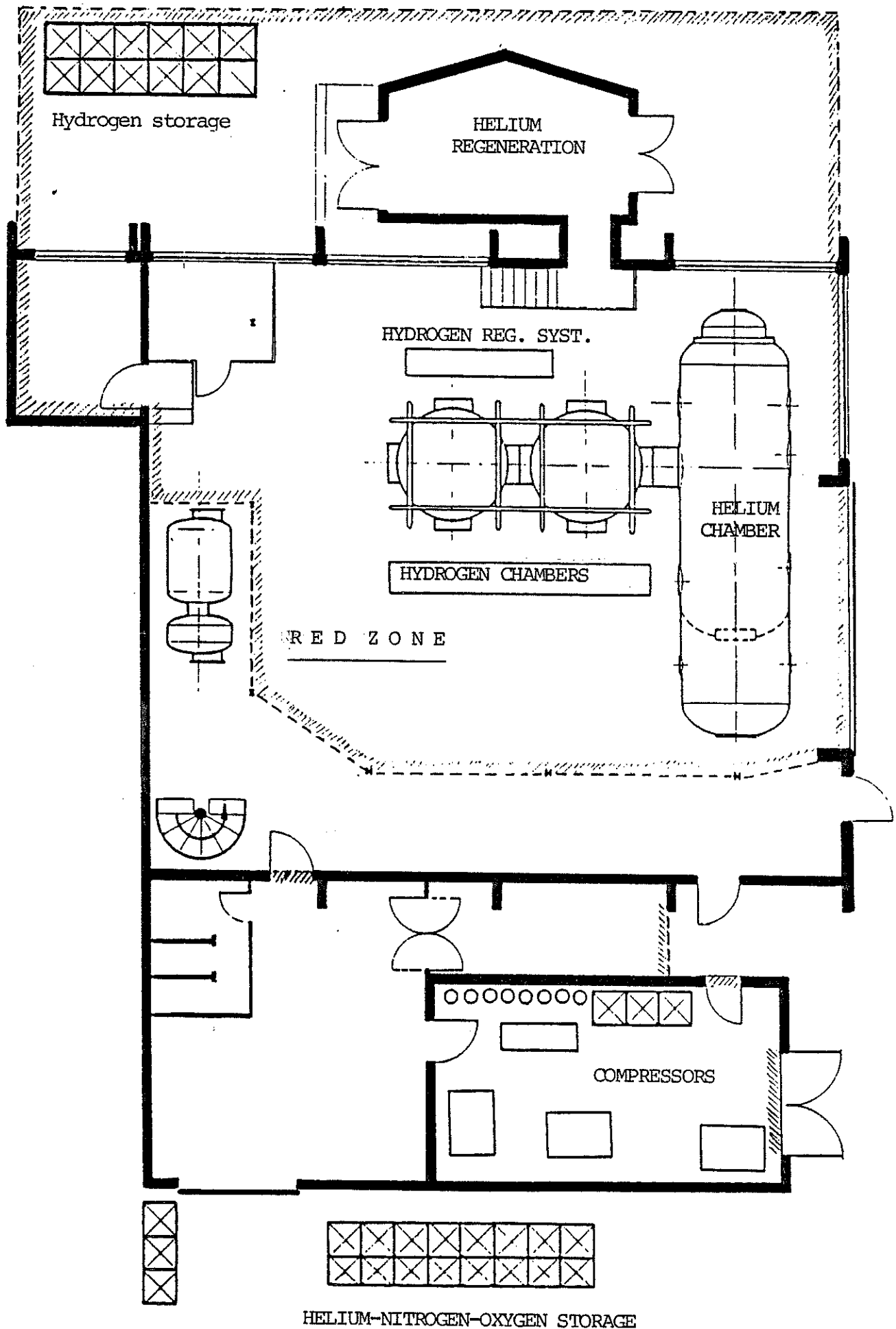

Figure 9 : HYPERBARIC RESEARCH CENTER GENERAL LAYOUT FOR HYDRA V

« THIS DOCUMENT IS THE PROPERTY OF COMEX, all information contained herein, neither be reproduced, used, disclosed, transmitted nor in any way made public without the written permission of the owner, any person in possession of this document acknowledges being bound by the obligation to treat it as confidential. »

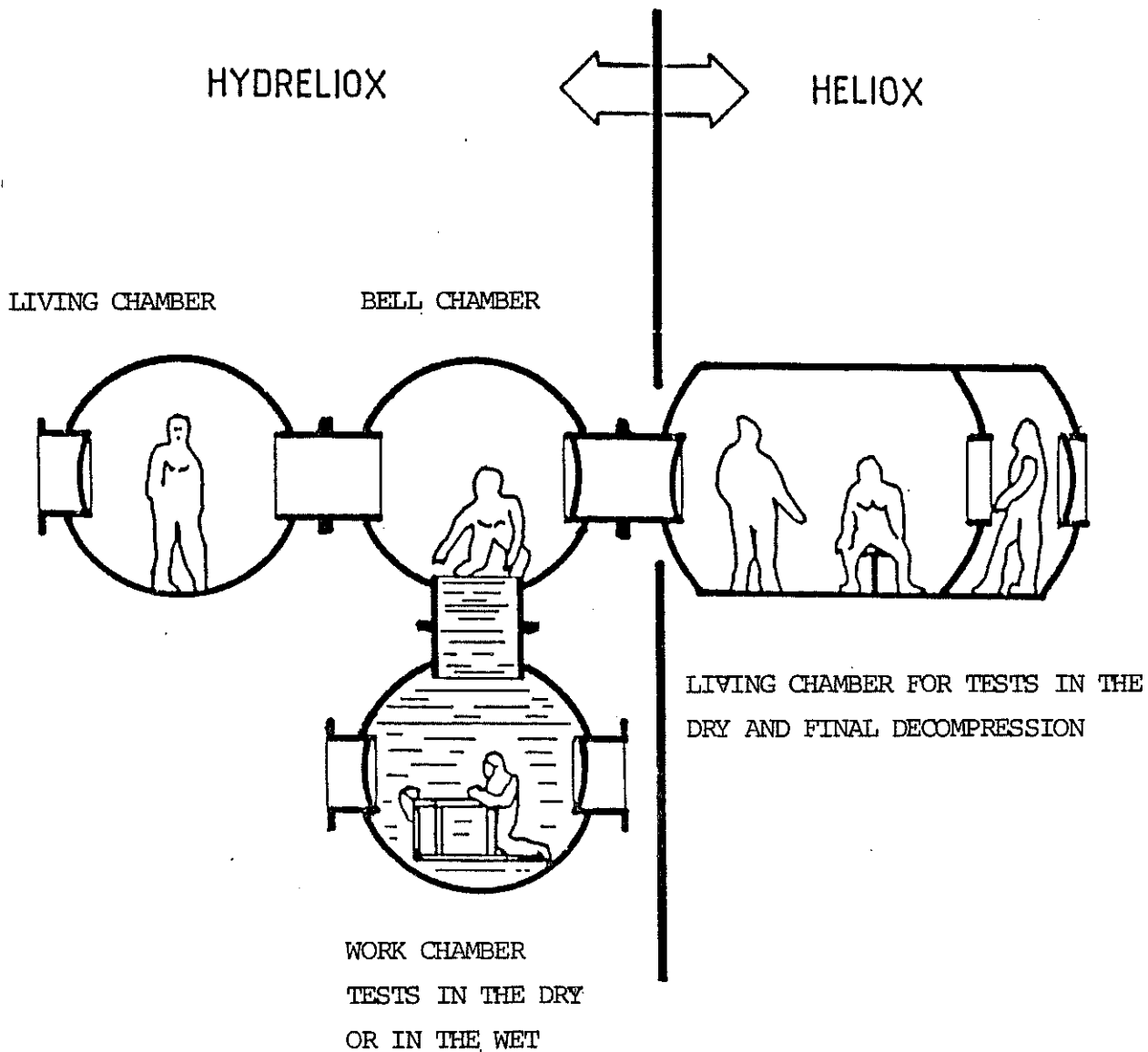

Figure 10 : General layout of saturation chambers

5.2 - Hydrogenated gas regeneration system

The breathing gas must be continuously regenerated during saturation so as to :

- eliminate carbon dioxide
- eliminate odours
- partially dehumidify gas to maintain relative humidity at a comfortable level
- maintain temperature within a comfortable range
- re-oxygenate the gas mixture to compensate for the divers' natural consumption during their stay "on the bottom" and to ensure a constant oxygen partial pressure during the long decompression phase.

For HYDRA V it was not possible to use traditional regeneration systems for obvious safety reasons. We thus designed a new system specifically for hydrogenated gases. Compactness was sought by eliminating all the pipes connecting the various modules in order to reduce danger of leakage as much as possible.

The various elements, exchangers, boosters and filters were incorporated in a single cylinder to be connected directly on to a chamber without using any valve or joining pipe (Figure 11).

The booster was linked to the electric motor via a magnetic coupling cooled by water from the condenser. With a variable-speed motor it was possible to vary the gas flow as a function of depth within a range of from several m^3 to $200 m^3/h$. This flow range ensured proper regulation of temperature and humidity down to 600 meters' depth in heliox or hydroliox.

Hot and cold water flow was automatically controlled by signals from

the temperature and relative humidity sensors in the saturation chamber.

The filtration compartment contains soda lime and charcoal providing an operating range of more than 120 hours with 3 divers. The HYDRA V range exceeded 150 hours on hydreliox.

Soda lime and charcoal are easily replaced by isolating, then decompressing the filtration compartment by a check valve system. During this operation gas still circulates through the exchangers and temperature-humidity control continues uninterrupted.

For HYDRA V the ECS was connected to EMS 600 spheres 1 and 2 by means of valves and rigid pipes. This arrangement offered a number of different possibilities :

- Exhaust and delivery in sphere 1, sphere 2 or both spheres at the same time,
- Exhaust in sphere 1 and delivery in sphere 2 (or vice versa).
- Exhaust in sphere 1 and delivery in sphere 3.
- Exhaust in spheres 1 and 2 and delivery in spheres 1 and 3.
- Exhaust in sphere 2 and delivery in sphere 3.

The ECS comprised an oxygen make-up by means of which the divers' natural oxygen consumption was automatically compensated in accordance with the measurement in sphere 1.

This device was specially designed for re-oxygenation of hydrogenated gases. Since manual oxygen make-up was impossible for obvious safety reasons, we installed two automatic systems in parallel (Figure 12).

The special feature of this system consists in sequential injection of oxygen while remaining on the safe side of flammability limits in the oxygen injection zone. Several safety devices ensure shut-down and

isolation of the automatic oxygen make-up system in the event of over-oxygenation or local combustion.

We are pleased to report that the entire system worked perfectly and that no failure occurred during the whole experiment.

Environmental parameters inside the chambers were maintained at the values required for physiological comfort with remarkable accuracy and reliability (Figure 13) :

- Ambient relative humidity

Constantly maintained between 50 and 52 %, i.e. maximum variations of ± 1 % in absolute value.

- Ambient temperature

Maximum discrepancy was 0.5° C despite variations of the hot water source of more than 10° C.

- Carbon dioxide

The absorption capacity of soda lime raised to more than 32 % in weight, whereas the supplier only guarantees it up to 20 %. This outstanding output was achieved by using a heat recuperator which kept the gas at the ideal temperature and humidity for soda lime.

The CO₂ partial pressure was lower than 3 mb at all times.

- Oxygen

The oxygen partial pressure was maintained at the preset values ± 2 mb during compression and bottom time as well as decompression.

5.3 - Gas circuits

All of the gas circuits on the EMS 600 were fully reconditioned and

and the hoses replaced by rigid stainless steel or copper pipes depending on the type of gas they conveyed.

Circuits were arranged to provide optimum flexibility in the handling of various mixtures (figure 14).

Hydrogen circuits were only put into operation after inerting with nitrogen, heliox or helium.

The decompression circuits of spheres 1, 2 and 3, the ECS scrubbing compartment, the lock and the waste water tank were blown out with nitrogen throughout the operation (Figure 15).

« THIS DOCUMENT IS THE PROPERTY OF COMEX, all information contained herein may neither be reproduced, used, disclosed, transmitted nor in any way made public without the written permission of the owner, any person in possession of this document acknowledges being bound by the obligation to treat it as confidential».

« THIS DOCUMENT IS THE PROPERTY OF COMEX, all information contained herein may neither be reproduced, used, disclosed, transmitted nor in any way made public without the written permission of the owner, any person in possession of this document acknowledges being bound by the obligation to treat it as confidential. »

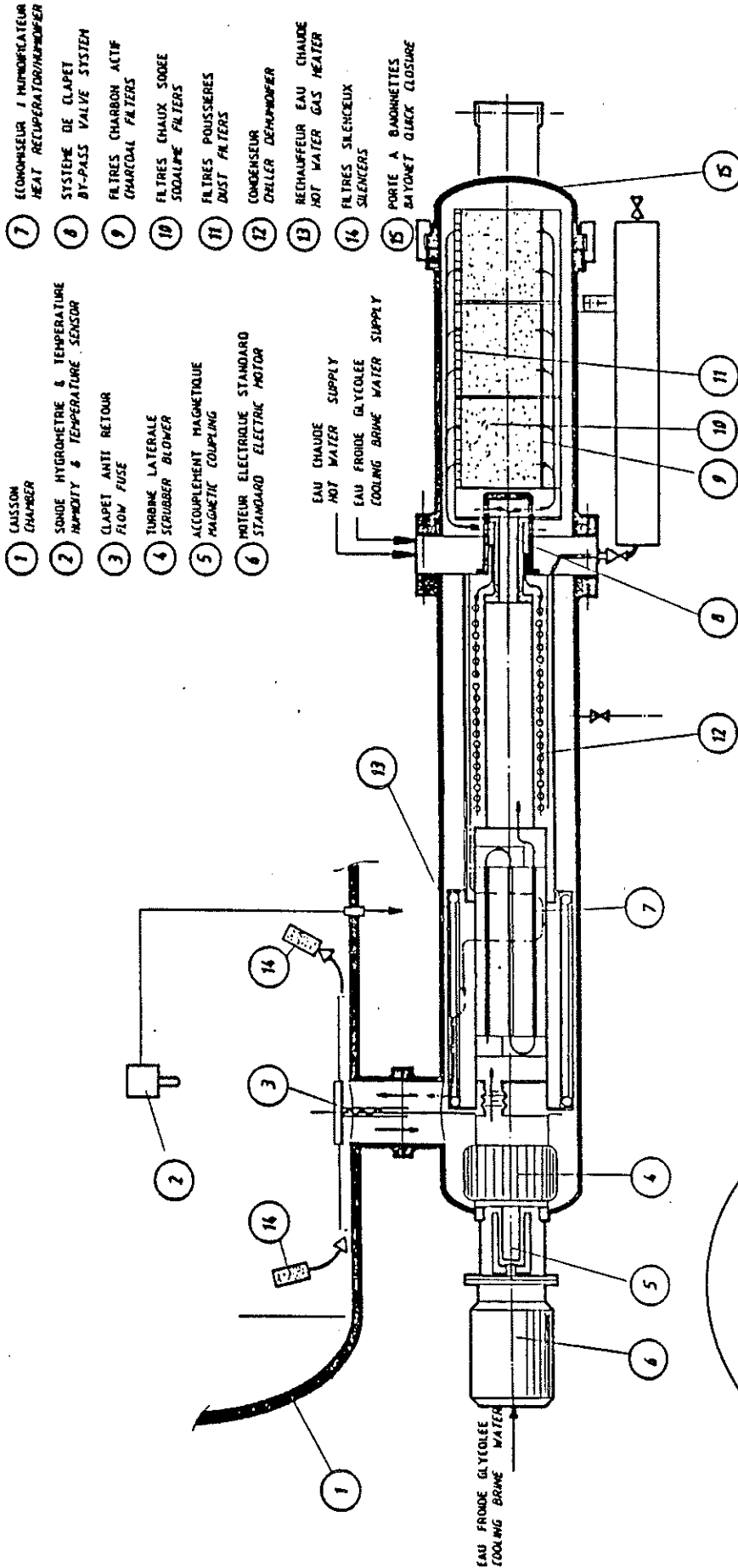

- 1 CHAMBRE CHAMBER
- 2 SONDE HYDROMETRE & TEMPERATURE HUMIDITE & TEMPERATURE SENSOR
- 3 CLAPET ANTI RETOUR FLOW FUSE
- 4 TURBINE LATERALE SCRUBBER BLOWER
- 5 ACCOUPLEMENT MAGNETIQUE MAGNETIC COUPLING
- 6 MOTEUR ELECTRIQUE STANDARD ELECTRIC MOTOR
- 7 ECONOMISEUR / HUMIDIFICATEUR HEAT RECOVERATOR/HUMIDIFIER
- 8 SYSTEME DE CLAPET BY-PASS VALVE SYSTEM
- 9 FILTRES CHARBON ACTIF CHARCOAL FILTERS
- 10 FILTRES CHAUDS SODRE SODALINE FILTERS
- 11 FILTRES POUSSIERES DUST FILTERS
- 12 CONDENSEUR CHILLER DEMUMIFIER
- 13 RECHAUFFEUR EAU CHAUDE HOT WATER GAS HEATER
- 14 FILTRES SILENCIEUX SILENCERS
- 15 PORTE A BADOINETTES BAYONET QUICK CLOSURE

Figure 11 :

EXTERNAL REGENERATION UNIT - PRINCIPLE
REGENERATION EXTERNE - TYPE A CONDENSATION
SCHEMA DE PRINCIPE

« THIS DOCUMENT IS THE PROPERTY OF COMEX. All information contained herein may neither be reproduced, used, disclosed, transmitted nor in any way made public without the written permission of the owner. Any person in possession of this document acknowledges being bound by the obligation to treat it as confidential »

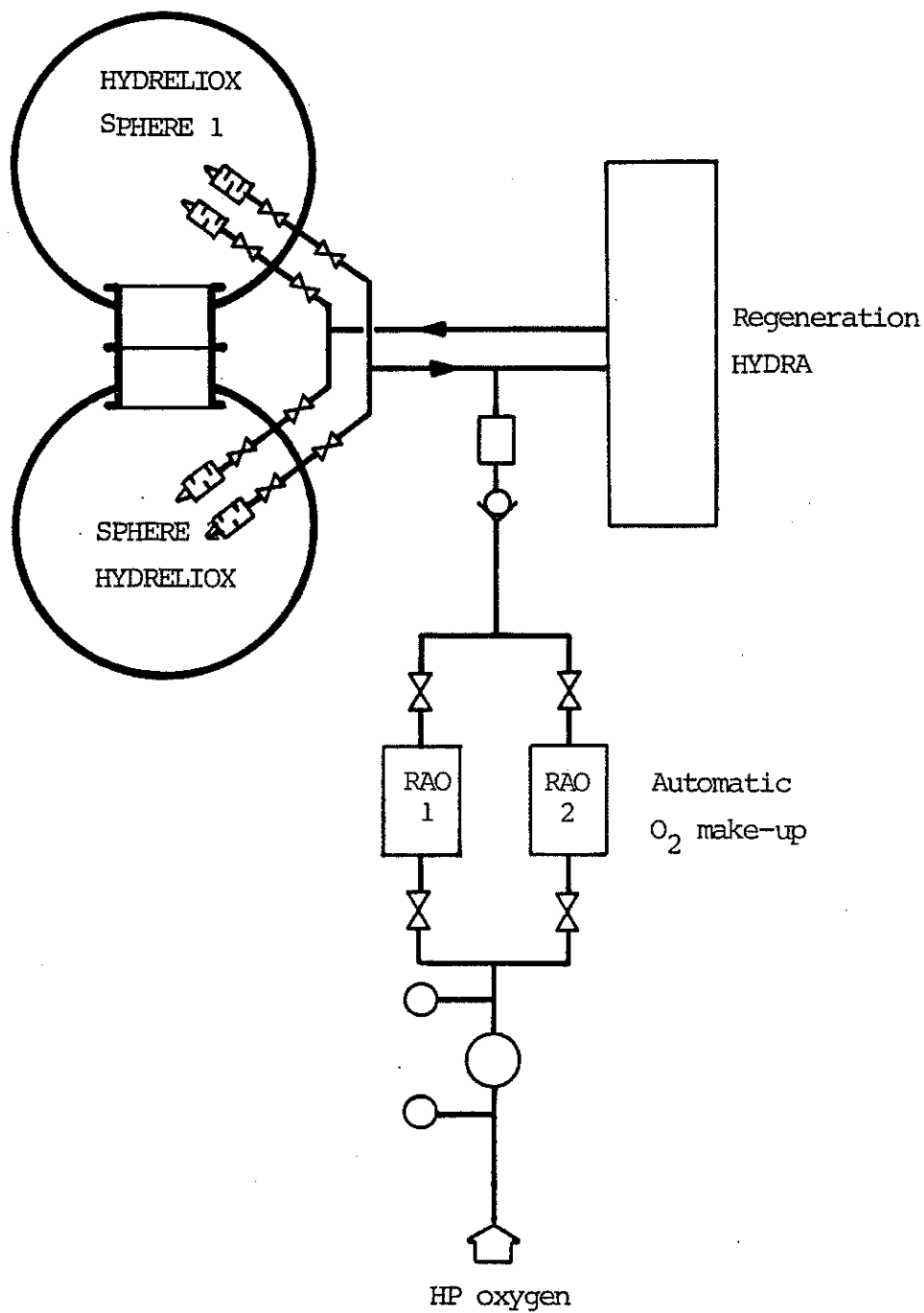

Figure 12 : Circuit diagram of oxygen make-up system

H Y D R A V

THIS DOCUMENT IS THE PROPERTY OF COMEX, all information contained herein, whether by reproduction, use, disclosure, transmitted nor in any way, shall be made public without the written permission of the owner, any person in possession of this document acknowledges being bound by the obligation to treat it as confidential.

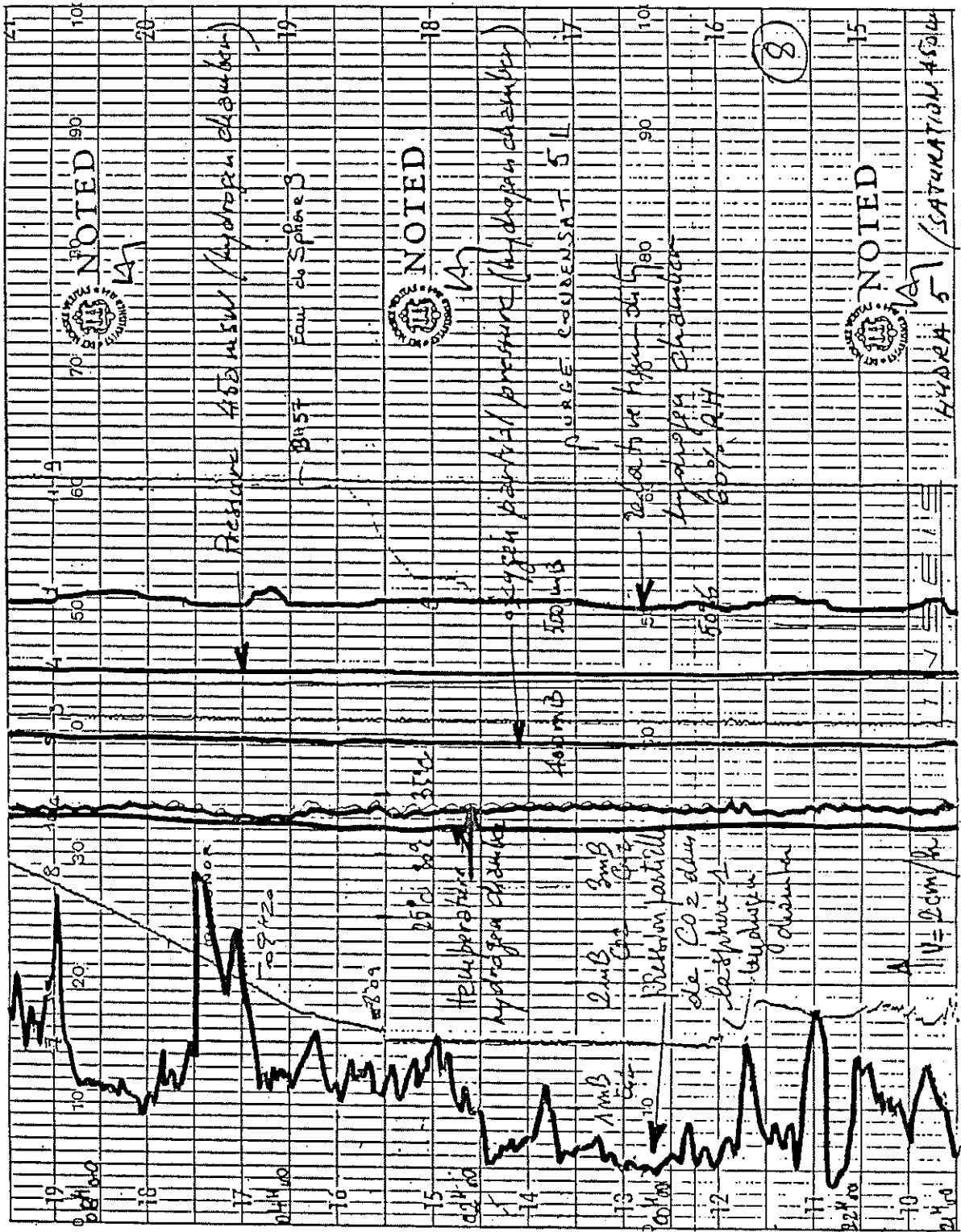

Figure 13 : Environmental parameters

HYDRA V

THIS DOCUMENT IS THE PROPERTY OF COMEX, all information contained here may neither be reproduced, used, disclosed, transmitted nor in any way made public without the written permission of the owner. any person in possession of this document acknowledges being bound by the obligation to treat it as confidential.

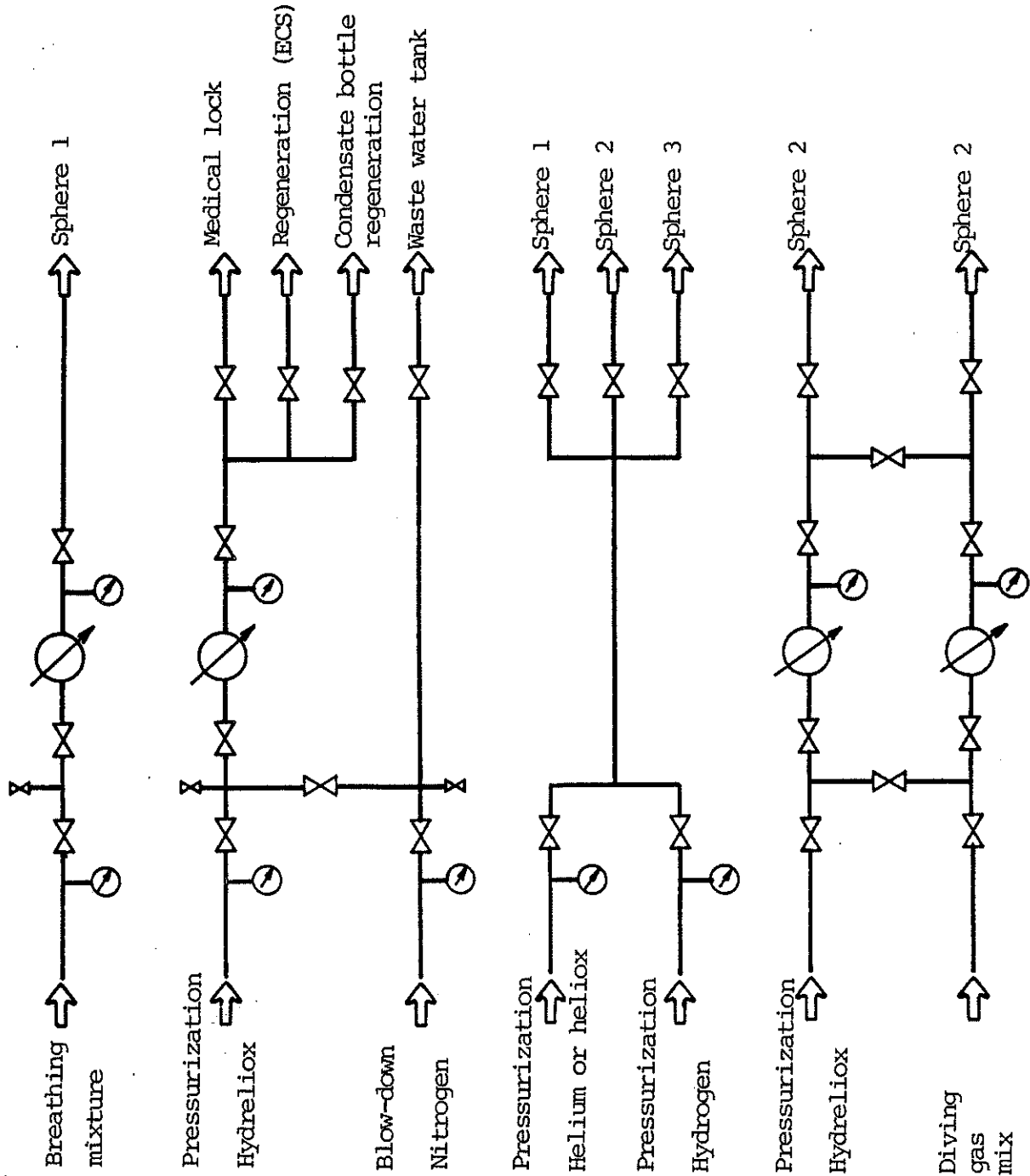

Figure 14 : Gas supply circuit diagram, EMS 600

HYDRA V

THIS DOCUMENT IS THE PROPERTY OF COMEX, all information contained here is confidential. It is not to be reproduced, used, disclosed, transmitted nor in any way made available to the public without the written permission of the owner. Any person in possession of this document acknowledges being bound by the obligation to treat it as confidential.

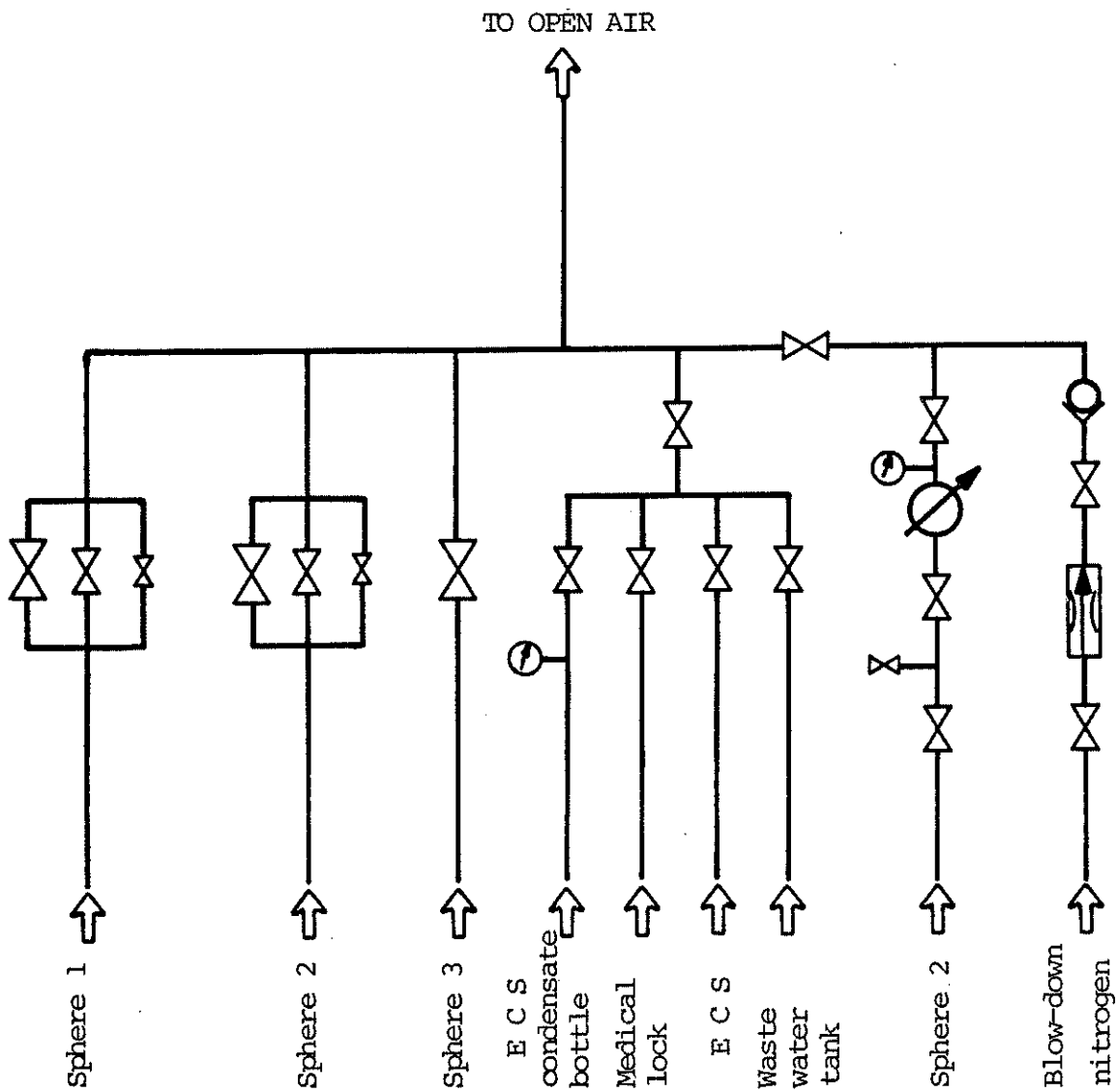

Figure 15 : EMS 600 decompression circuit diagram

H Y D R A V

6 - SAFETY DEVICES

The results of the research on hydrogen flammability limits proved that risks are almost non-existent in the chambers below a depth of 200 meters, for the oxygen concentration is too low.

Great caution must be exercised outside the chambers, however, for hydrogen has a very high flammability potential in air.

The flammability limits of hydrogen at atmospheric pressure are the following :

- low limit : 4 %
- High limit : 74.5 %

These correspond to an oxygen content ranging from 20.1 % to 5.3 %. It was thus necessary to make a thorough study of leakage risks and to provide effective means of eliminating them.

For HYDRA V we equipped the EMS 600 with a big extraction hood covering spheres 1 and 2. This hood was connected to the outdoors by a large 36" diameter sheath and a powerful gas exhaust system with a two-speed hydrogen-class explosion-proof electric motor (Figure 16).

A set of 8 hydrogen detectors was installed under the hood and connected to a control device with two alarm thresholds (Figure 17). Each detector was linked to an electronic module fitted out with :

- an ON signal light,
- a sensor failure light,
- a first alarm threshold warning light,
- a second alarm threshold warning light,
- a sound alarm to go off at the first alarm threshold

The alarm relay outlets automatically turned on the extractor and a powerful flashing light.

Alarm thresholds were fixed at the following values :

- Threshold 1 : 0.15 % hydrogen

Starting up of the first extraction speed, corresponding to a flow rate of 20 000 m³/h, and the orange flashing light.

- Threshold 2 : 0.5 % hydrogen

Starting up of the second extraction speed corresponding to a flow rate of 40 000 m³/h, and the red flashing light.

It should be noted that the 40 000 m³/h extraction rate slightly depressurizes the experimental center. The slightest leak would therefore be immediately diluted in the air and drawn out of the building.

The surface operators could also manually control the extractor. In case the extractor was to be manually operated in first or second speed the operator was warned of a hydrogen alarm by the flashing light and the sound alarm of the electronic module.

The COMEX Research Center was originally equipped with 3 extractors (unit flow rate : 6000 m³/hr) and we had them working continuously as a safety measure.

It should also be mentioned that the temperature difference inside and outside the building resulted in a natural ventilation via the hood by convection.

The following table indicates the air speeds in the hood and the sheath as a function of the extraction rate.

	20 000 m ³	40 000 m ³
In the extraction sheath	8,75 m.sec ⁻¹	17,5 m.sec ⁻¹
At the bottom of the hood	0,6 m.sec ⁻¹	1,2 m.sec ⁻¹

When the first team of divers was on hydrogen the detection system enabled us to detect a leak in the feedthrough of the circuit supplying the breathing gas to the mass spectrometer. This leak was able to be checked in complete safety by the combined efforts of the divers and the surface technicians.

« THIS DOCUMENT IS THE PROPERTY OF COMEX. all information contained herein may neither be reproduced, used, disclosed, transmitted nor in any way made public without the written permission of the owner. any person in possession of this document acknowledges being bound by the obligation to treat it as confidential. »

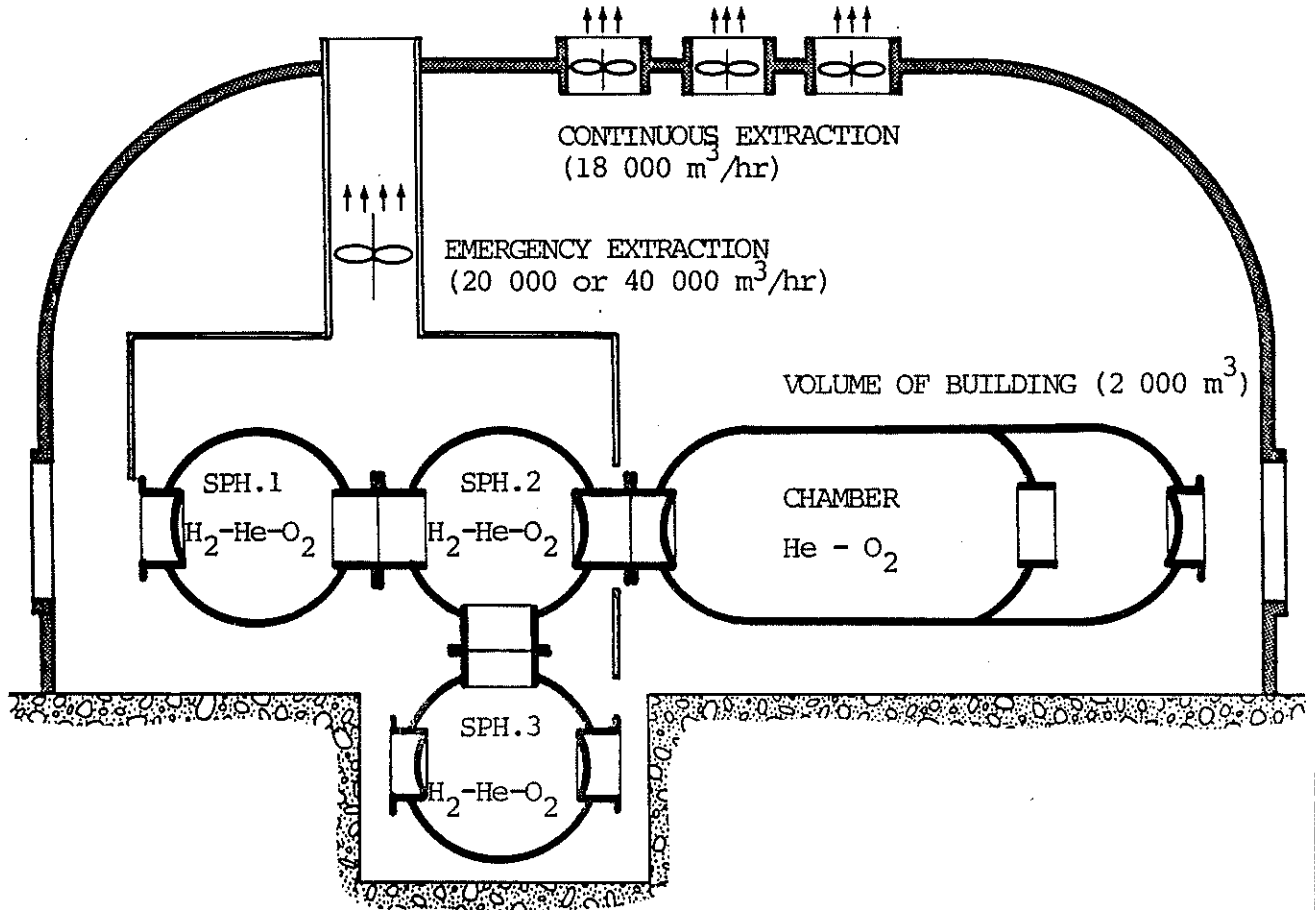

Figure 16 : Circuit diagram of extraction system for possible hydrogen leaks

HYDRA V

THIS DOCUMENT IS THE PROPERTY OF COMEX. All information contained herein may neither be reproduced, used, disclosed, transmitted nor in any way made public without the written permission of the owner. Any person in possession of this document acknowledges being bound by the obligation to treat it as confidential.

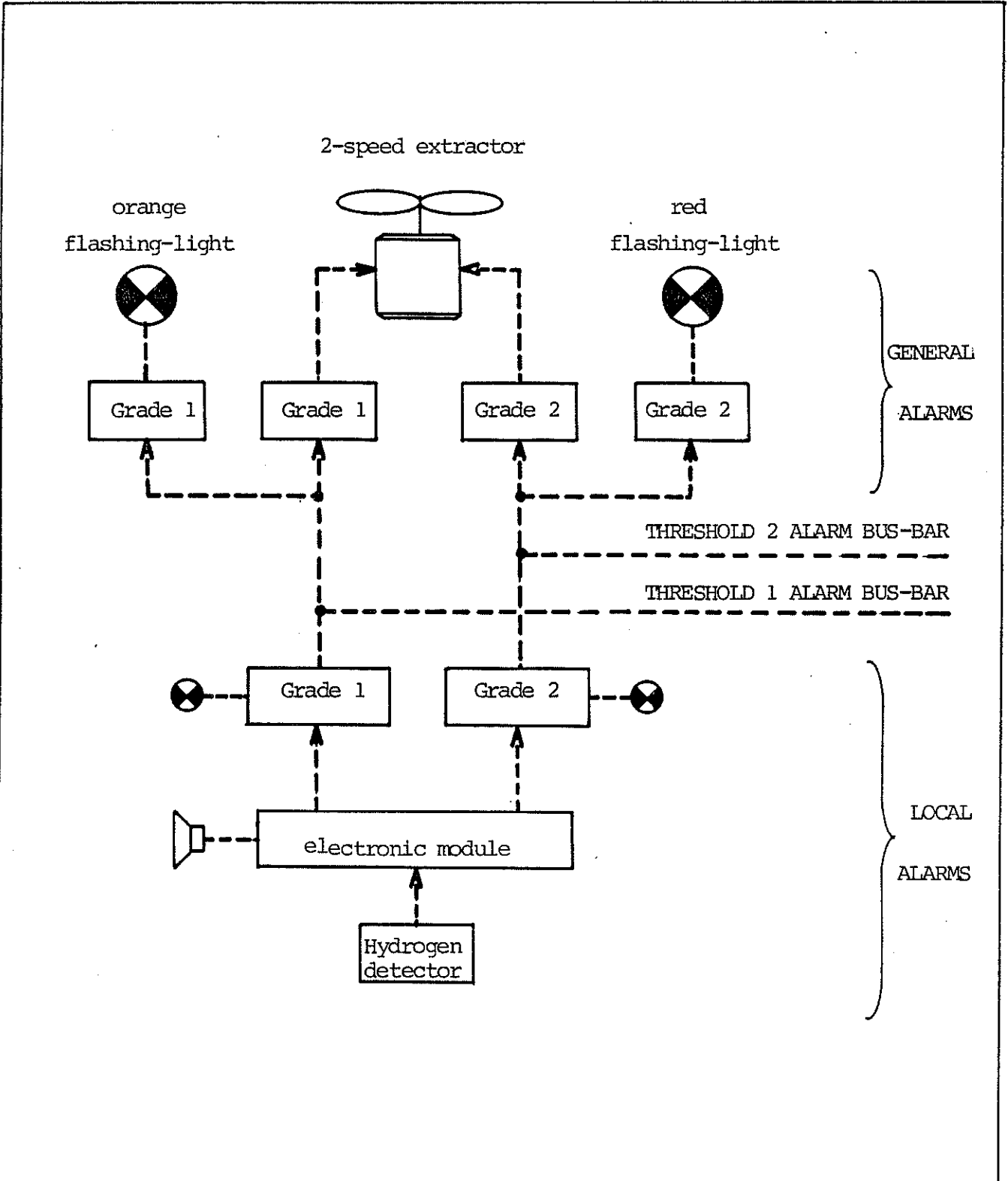

Figure 17 : Circuit diagram of hydrogen detection and extraction system

H Y D R A V

7 - PROCEDURES FOR OPERATING THE EQUIPMENT

We will not give here the detailed procedures themselves, as these are set forth in a special paper.

These procedures were drawn up with the principle in mind that at no time, under no circumstances, and at no point in the diving system and its peripheral facilities could there be any possibility of producing a flammable mixture.

The procedures cover :

- pressurization of the sphere complex
- depressurization and repressurization of sphere 1 and 2
- depressurization and repressurization of sphere 3 for technical operations in the dry
- filling sphere 3 with water after opening to the atmosphere
- replacing the water in sphere 3
- reducing hydrogen content in spheres 1 and 2
- increasing hydrogen content in spheres 1 and 2
- operating the food and medicine lock of sphere 1
- operating the sanitary tank of sphere 2
- bleeding the regeneration condensate recovery bottle
- changing ECS soda lime and charcoal
- blood sample decompression chamber

- transferring divers from the EMS 600 spheres to the 60-bar chamber and vice versa
- using the automatic oxygen make-up system
- preparing hydrogen circuits before using them for hydrogen or hydreliox
- using the hydrogen mix
- physiological tests in the dry in sphere 3
- hydrogen consumption and preparation of hydreliox

8 - CONCLUSIONS

In conducting this experiment we have proved that heavy saturation diving equipment initially intended for helium can be adapted to hydrogen and offer full safety guarantees. Modifications are required only in some of the associated sub-systems.

No significant technical difficulty occurred during the experiment. The equipment developed specifically for HYDRA V, particularly the gas regeneration system and the automatic oxygen make-up, worked perfectly throughout the 36 days of the experiment.

The diving system was also put on hydrogen without any difficulty because the simple safety procedures and rules which we imposed upon the surface technical and scientific teams were respected at all times

HYDRA V

ORGANIZATION, PROCEDURES, DAILY SCHEDULE

B. GARDETTE, Direction Scientifique, COMEX Marseille

I - ORGANIZATION1) COMEX TEAM

Director of operations : H.G. Delauze

Scientific Directors : X. Fructus and B. Gardette

Technical Director : C. Gortan

Scientific and Medical Staff : M. Comet
M. Carlioz

Technical Staff

- Laboratory : A. Bened
M. Trovallet

- Diving Supervisors : J. Coustal

- Shift Supervisors : A. Martin
P. Martin

- Technicians : S. Clairet
B. Borrione
Y. Bonnier
P. Roux
P. Vittori

- Safety Superintendent : J.P. Mary

- Public Relations : C. Jatteau
J.P. Imbert

2) SCIENTIFIC TEAMS

- = CEPISMER/GISMER (French Navy) : D. Lamy
- = CERB (Toulon Naval)
 - B. Broussolle
 - J.L. Morcellet
 - P. Giry
 - R. Hyacinthe
 - A. Elizagaray
 - B. Puech
 - A. Battesti
 - A. Baret
 - A. Courtière
 - C. Verbier
 - G. Perazza
 - R. Bugat
- = CERTSM/DCAN (Toulon Naval) : G. Masurel
 - N. Gutierrez
 - M.C. Giacomoni
- = GIS/CNRS : R. Naquet
 - G. Imbert
 - A. Chattut
 - A. Folco
 - J.C. Rostain
 - M.C. Gardette-Chauffour
 - A. Burnet
- = INPP : P. Gavarry
 - E. Clogenson
- = OCTARES : C. Lemaire
 - E. Martinez
 - D. Guldner
- = NMRI (US Navy) : E.T. Flynn
 - M. Ackerman
 - R. Benvard
- = NDRI (Swedish Navy) : H.C. Ornhamen

The operation was under the responsibility of three committees :

■ Management committee :

- H.G. Delauze, COMEX Chairman
- Capitaine de Vaisseau Serve, French Navy

■ Technical Committee :

- C. Gortan, COMEX
- Capitaine de Frégate Harismendy, French Navy
- B. Pillaud, IFREMER

■ Scientific Committee :

- Médecin-Général Broussolle, Service de Santé des Armées,
- Dr X. Fructus, COMEX
- Médecin-Chef Lamy, French Navy
- Dr R. Naquet, C.N.R.S.

II - EQUIPMENT

a) Hyperbaric complex

Part of the COMEX hyperbaric research centre facilities in Marseilles were used, including :

UNIT N° 1 : A system three spherical chambers connected to the heliox chamber in which three divers can stay in hydrogenated gas mixture under physiological and medical controls and perform exercise tests in dry and wet conditions.

This system was equipped for detection of H₂ exhauts with alarms and extraction outside hyperbaric center hall.

UNIT N° 2 : A chamber with lock under heliox, which can accommodate six divers.

b) Individual equipment for the dive

For the test in the wet the divers were kitted up with :

- a one-piece COMEX PRO suit without hood made of 5 mm thick neoprene with fastening,
- neoprene boots,
- safety harness,
- weights,
- emergency twin set (V = 3,33 l x 2; P = 200 b) filled with bottom mixture,
- new integral wet helmet COMEX PRO, with T8 demand/dump valve connected to the dry wall by an umbilical composed of :
 - . life-line
 - . in-out breathing gas supply line
 - . communications line
 - . ECG and magnetometers lines
 - . mass-spectograph line
 - . oro-nasal temperature line
 - . mouth barogram line

Exercise tests were performed on cyclorower.

PLONGEUR ÉQUIPE DU CASQUE COMEX PRO 18 A 450 MÈTRES SOUS MÉLANGE HYDROGÈNE
DIVER EQUIPPED WITH COMEX PRO 18 HELMET AT 450 MSW UNDER HYDROGEN MIXTURES

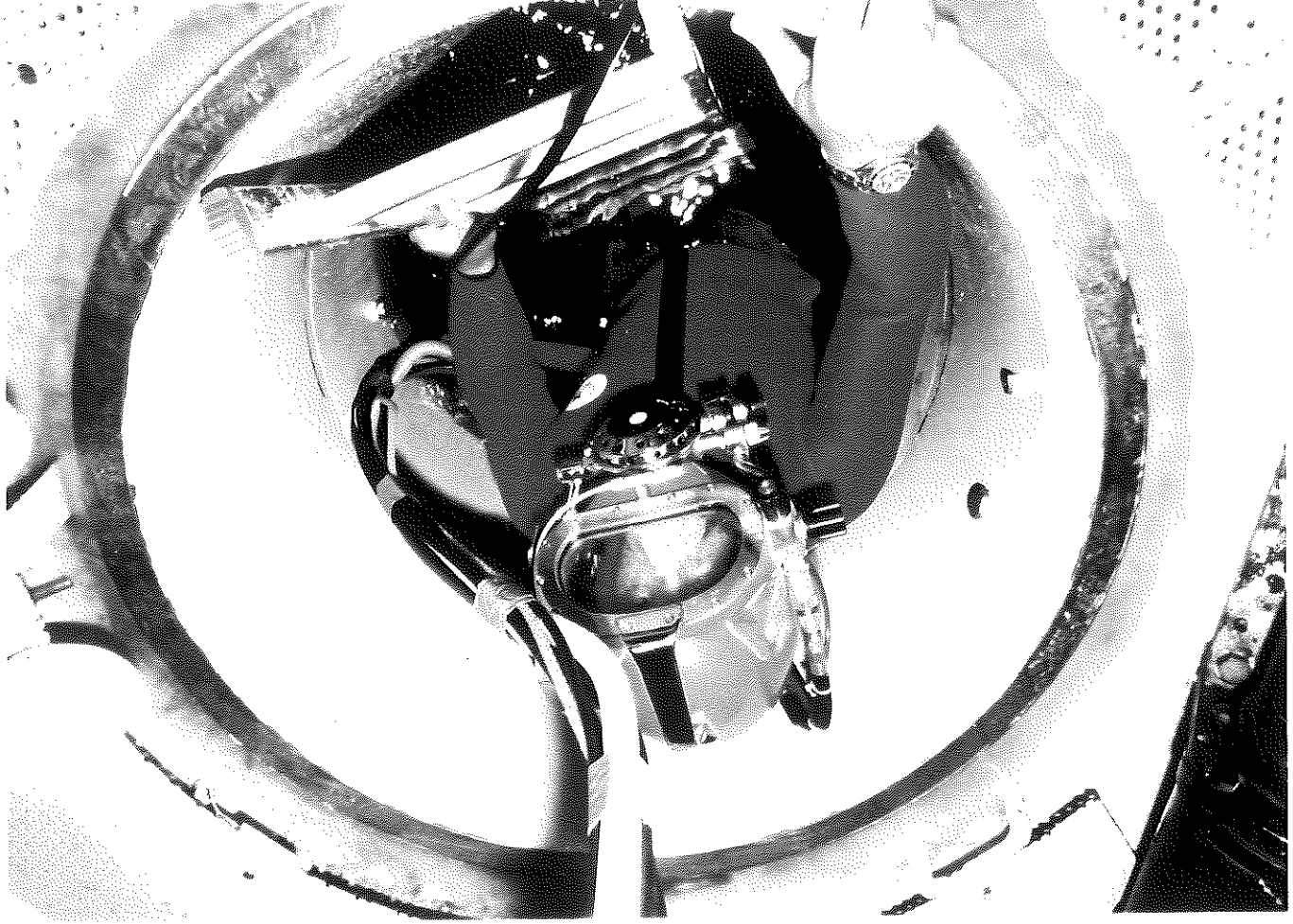

ENSEMBLE DE CAISSONS HYPERBARES ADAPTES AUX MELANGES HYDROGENES
HYDROGEN MIXTURES HYPERBARIC CHAMBERS

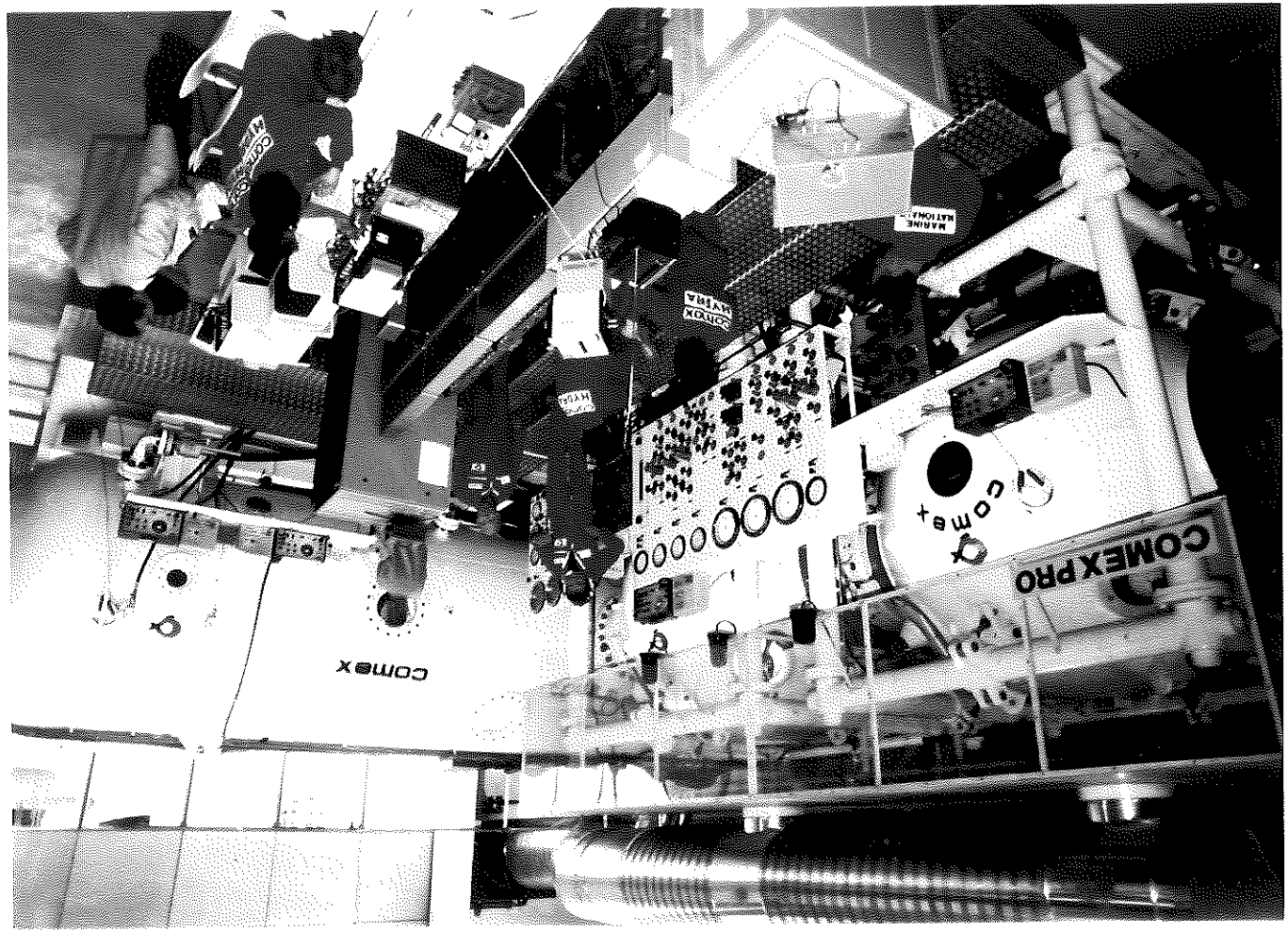

III - THE DIVERS

Six divers were selected for HYDRA V :

- 3 COMEX divers,
- 2 divers from the GISMER (Groupe d'Intervention Sous la Mer),
FRENCH NAVY,
- 1 diver from the INPP (Institut National de Plongée Professionnelle).

They were divided into two groups :

TEAM A : 3 divers

A₁ ; J.G. Marcel-Auda (GISMER)

A₂ : P. Raude (COMEX)

A₃ : L. Schneider (COMEX)

TEAM B : 3 divers

B₁ : S. Icart (GISMER)

B₂ : Y. Langouët (COMEX)

B₃ : J.P. Macchi (INPP)

IV - METHODS AND PROCEDURES

- 1) Compression techniques for deep dives using He-O₂, He-N₂-O₂ and H₂-He-O₂ mixtures

After the human dives made in the CORIAZ series (1975) - Rapid compression in 4 hours to 300 msw with different percentages of nitrogen in heliox -

CORAZ I	: 9 % N ₂
CORAZ II, III	: 4,5 % N ₂
CORAZ IV	: 0 % N ₂

we undertook a systematic study of the influence of nitrogen on the intensity of the HPNS in the monkey *Papio papio*. That was the CORASIN series - compression in 2 hours to 600 msw. The results obtained have led us to develop a compression technique with the following characteristics : decreasing speed as depth increases; short duration intermediate stages; introduction of nitrogen before each stage, to obtain 8 % at 600 msw. This method of compression made possible to minimize the HPNS at 600 msw (CORASIN VIII) and to reach a 1000 msw depth (CORNELIUS I).

Extrapolation of this procedure to man, during two compressions to 400 and 300 msw in JANUS IV, phase II and III, showed an increase in the modifications of the EEG during the first phase of the compression (the most rapid), between 0 and 300 msw.

The reduction of speed at the beginning of the compression in the experiments with the monkeys (CORNELIUS II and III) as far as 100 msw using 5 % N₂ minimized the clinical symptoms of HPNS and EEG modifications.

A human dive to 450 msw was also carried out using this new procedure. 8 subjects were taken to 450 msw in 38 hours (DRET 79/131) without clinical symptoms and without any important increase in theta EEG activity.

The same compression procedures were used in ENTEX 5 and 8 (450 msw - 12 days) with 4.8 % N₂ and in ENTEX 9 (450 msw and 610 msw) without adjunction of nitrogen in the heliox mixture.

2) ENTEX and HYDRA V compression procedures

0 - 10 msw : Heliox = 0.4 b O₂

10 - 450 msw : 38 hrs

- with stops every 100 msw

duration of each stop : 150 min (2 hrs 30)

- decreasing speed with depth

0 - 100	2	min/m
100 - 200	2,5	" "
200 - 300	4	" "
300 - 400	5	" "
400 - 500	7	" "

- Gas mixture - in DRET 79/131, ENTEX 5, ENTEX 8

He N₂ O₂ / 4.8 % N₂ - Adjunction of 3.5 m N₂

each stop : 2.2 bars of N₂ at 450 msw

- in ENTEX 9 (between 10 and 450 msw)

He O₂, without adjunction of N₂ : PN₂ = 0.8 b = 2 N₂

- in HYDRA V

■ gas mixture : helium up to 200 msw

hydrogen between 200 and 450 msw

H₂ He O₂ 25 b

20.6 b He = 45 %

0.4 b O₂ = 1 %

≈ (0.05 b N₂ = 0.1 %) elimination before compression from
0 to 10 msw

■ compression duration

He : 14 hrs (10 - 200 msw)

H₂ : 26 hrs (200 - 450 msw)

3) Gas switch : from H₂ He O₂ to He O₂

After four days at bottom depth, the three divers of team A were transferred from an hydrox atmosphere - 54 % H₂ at 450 msw (25 b H₂) to an heliox atmosphere with an 8 hrs intermediate hydrox mixture stop - 30 % H₂ at 450 msw (14 b H₂).

Though the gas switch was progressive, it appeared it was even too rapid and the divers on heliox were recompressed to 470 msw with an increase of the PIO₂, from 0.4 b to 0.6 b. After a very slow decompression to 450 msw, they stayed at bottom depth for additional tests designed for comparison between heliox and hydrox.

Subsequently, the dive planning of Team B was modified and converted into a complete hydrox dive procedure that will certainly be adopted for future operations : compression with hydrogen when deeper than 200 meters, stay under hydrox atmosphere at bottom and decompression to 200 msw with H₂ progressive elimination.

4) Bottom time durations

	TEAM A (3 DIVERS)	TEAM B (3 DIVERS)
H ₂ He O ₂ at 450 msw	72 hrs (3 days)	104 hrs (4 D 8hrs)
He O ₂ at 450 msw	128 hrs (5 D 8 hrs)	0
TOTAL	200 hrs (8 D 8 Hrs)	104 hrs (4 D 8hrs)

5) HYDRA V decompressions

TEAM A : The three divers were decompressed on heliox from 450 msw to the surface in 14 days 10 hrs.

$$\text{Rate} \left\{ \begin{array}{l} 450 - 15 \text{ msw} = 45 \text{ min/m} \\ 15 - 0 \text{ msw} = 60 \text{ min/m} \end{array} \right.$$

$$\text{PO}_2 \left\{ \begin{array}{l} 450 - 350 \text{ msw} = 0.6 \text{ b} \\ 350 - 120 \text{ msw} = 0.5 \text{ b} \\ 120 - 15 \text{ msw} = 0.6 \text{ b} \\ 15 - 0 \text{ msw} = 24 \% \end{array} \right.$$

At the end of decompression, near the surface, 1 meter, two divers had a slight pain in the knees. Team A was recompressed to 4msw, on air with pure O₂ inhalations, and, then decompressed to the surface (speed = 90 min/m).

TEAM B : The decompression was conducted with progressive elimination of hydrogen from 450 msw to 200 msw. From there to surface, the ascent was carried out in an heliox atmosphere. This saturation decompression was the first one ever performed with hydrogen and was closely monitored, using ultrasonic bubble detector technique.

Decompression duration : 19 days 10 hrs.

- on hydrox : 11 days 17 hrs (450 - 157 msw)
- on heliox : 7 days 17 hrs (157 - 0 msw)

450 - 350 msw = 70 min/m

350 - 300 msw = 65 min/m

300 - 250 msw = 60 min/m

250 - 15 msw = 55 min/m

15 - 0 msw = 120 min/m

450 - 100 msw = 0.5 b

100 - 15 msw = 0.6 b

15 - 0 msw = 24 %

Team B arrived at surface on Friday 7 June at 10.00 am without problem

Total time exposure on hydrox : 17 days 3 hours

6) Investigations

- | | | |
|--|---------------------------|---------------------------------------|
| - Clinical observations | COMEX - GISMER - CEPISMER | |
| - Tremor quantified | } | |
| - EEG quantified | | GIS/CNRS |
| - Sleep EEG | | |
| - Psychometric performances | } | |
| - Psychology | | OCTARES, SWEDISH NAVY,
COMEX, CERB |
| - Ventilatory investigations in dry conditions, at rest and during exercise on bicycle ergometer | } | |
| - Ventilatory investigations in wet conditions, at rest and during exercises on cyclorower ergometer | | CERB |
| - Cardiac adaptation to effort : dry and wet conditions | } | |
| - Bubble detection | | NMRI (US NAVY) |
| - Scintigraphy : lungs, skeleton, heart | CERTSM | |
| - Biology in blood and in urine | CERB | |
| - Ophthalmology | CERB | |
| - New regeneration systems with permanent reoxygenation of ambient gas to compensate diver's normal O ₂ consumption | } | |
| | | C.O.M. |
| | } | |
| | | COMEX |

L'ÉQUIPE A SOUS MÉLANGE HYDROGÈNE A 450 MÈTRES REALISANT LES TESTS PSYCHOMETRIQUES
TEAM A UNDER HYDROGEN MIXTURE AT 450 MSW DURING PSYCHOMETRIC TESTS



LES SIX PLONGEURS D'HYDRA V
THE SIX HYDRA V DIVERS

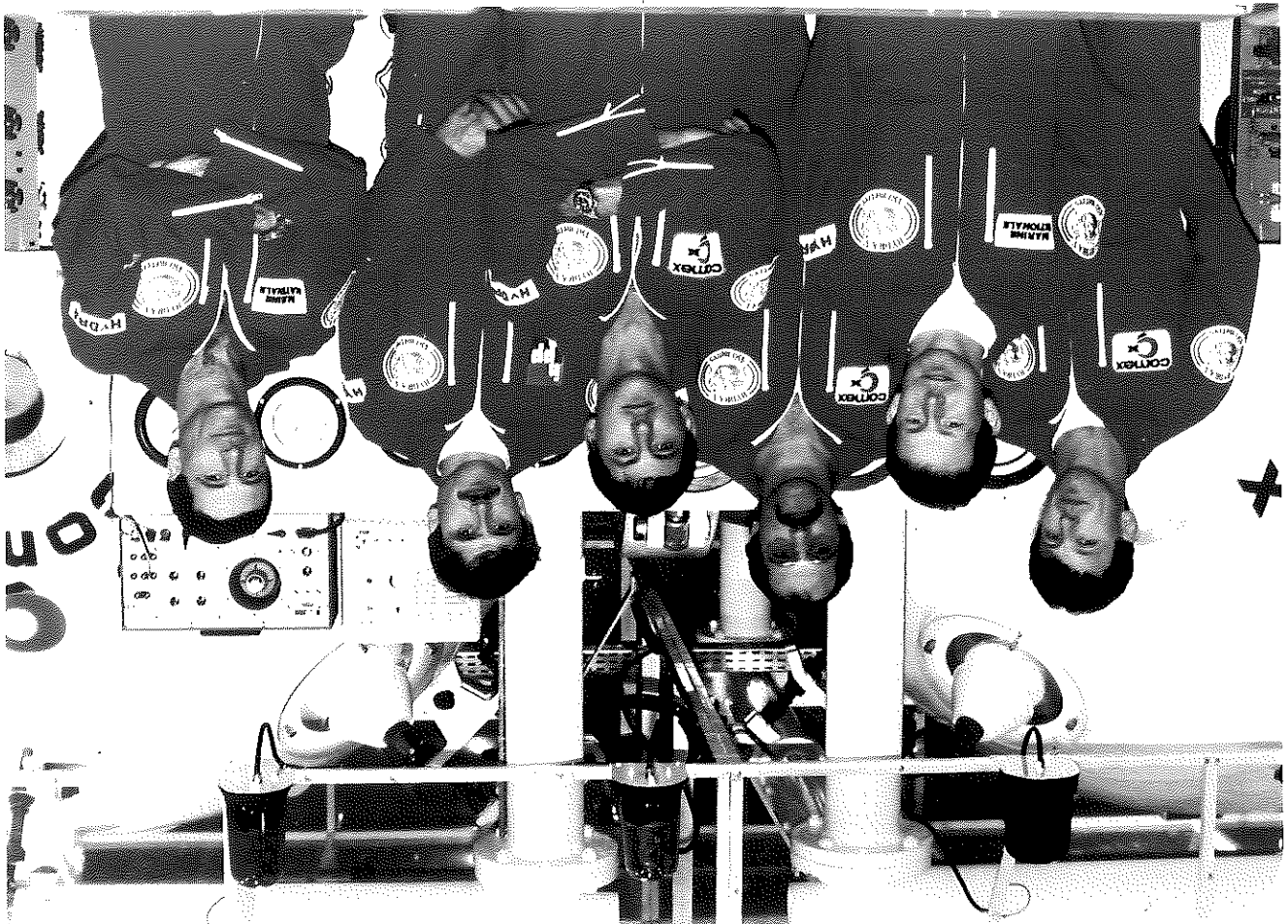

TEAM B IN HELIUM CHAMBER DURING ERGOMETRIC BICYCLE EXERCISE

BICYCLETTE ERGOMETRIQUE

EQUIPE B DANS LE CAISSON HELIUM REALISANT LES EXERCICES SUR

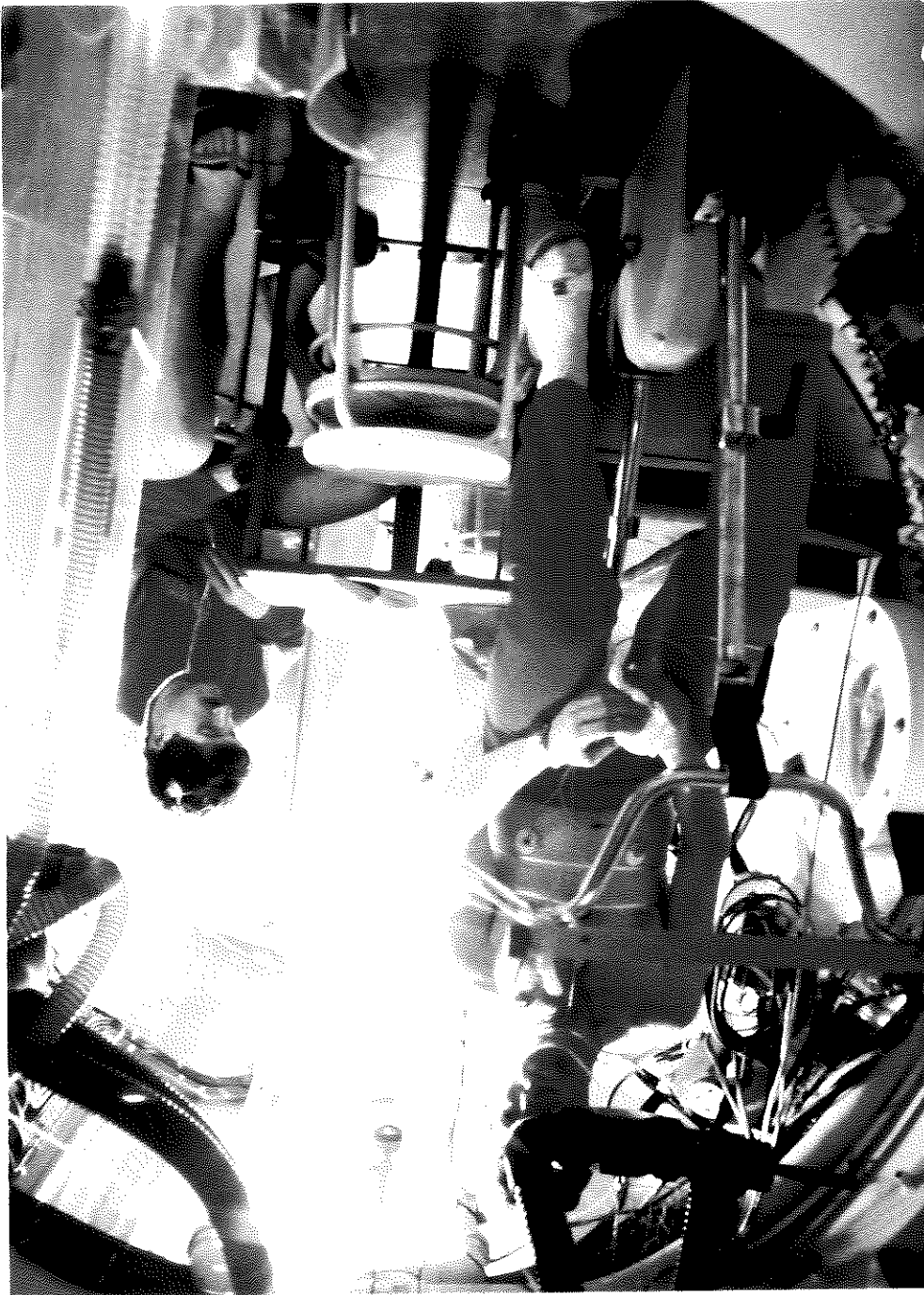

- 7) Selection :
- The medical examinations for the selection of the divers, made in 9 professional divers, included :
- a clinical examination
 - a scintigraphy (bones, heart and lungs)
 - tests of cardiac and ventilatory adaptation to effort (with respiratory resistance)
 - ophthalmological tests
- 8) Training :
- Psychometric tests
 - Technical diving training

V - DAILY SCHEDULE

★ PREPARATORY PHASE

Teams A and B = 9 divers (3 of them being replacement divers)

- April 15, 16, 17, 18, 19

- Physical training

- Medical training

- Radionuclide heart scan

- Ophthalmologic tests

- April 22, 23, 24, 25, 26

- Dives in water, sphere 3

- Psychometric tests training

- Radionuclide bone and pulmonary scans - ventilatory and

biological references

- April - May : 29, 30 - 1, 2

- Dry chamber bounce dives to 66 meters for 20 minutes, nitrox breathing by mask : 5.3 % O₂ (0.4 b)
- Psychometric tests for narcosis
- Exercise in the dry

★ HYPERBARIC PHASE

TEAM A (3 DIVERS)

D Dates Chronology Depth in Data Scientific activities

D	Dates	Chronology	Depth in	Data	Scientific activities
D ₀	Friday 03/05	Lights out	0	Surface	Sleep - Divers with-out EEG electrodes
D ₁	Satur. 04/05		0		EEG electrode fastening
		17.00			EEG
		20.30	10	Confinement He O ₂ (80/20) After 6 Flushing	
		22.00			Lights out
D ₂	Sunday 05/05	Wake up			Beginning of daytime urine-taking
		08.00	10	Confinement He = 1.55 b (77.4 %) O ₂ = 0.4 b (20 %) N ₂ = 0.05 b (2.6 %)	Bubble detection
					EEG - Tremor
					Psychometry
					Ophthalmology
		12.00			Lunch
		14.30			Rest
					Psychology
					Ophthalmology
					EEG - Tremor
			10		Psychometry
					Clinical
					End of daytime urine taking/Beginning of nighttime urine taking
		22.00			Lights out
D ₃	Monday 06/05	Wake up	10	Confinement He O ₂ (80/20) PO ₂ = 0.4 b	Blood sampling
					End of nighttime urine taking
					EEG - Tremor
		08.30			Exercise in the dry
		13.00			Lunch
		14.00			

D	Dates	Chronology	Depth m	Data	Scientific Activities
D ₃	Monday 06/05	14.30 18.30 19.00 20.00 22.00	10		Exercise in the dry EBG - Tremor Clinical Sleep EBG
D ₄	Tuesday 07/05	02.00 05.00 07.00 11.40 14.10 14.10 19.00	10 100 200	Beginning of compression He - 2 m/n/m PO ₂ = 0.4 b Compression He 2.5/m/n PO ₂ = 0.4 b EBG - Tremor Psychiatry Wake up Stop 2 h 30 Compression He 2.5/m/n PO ₂ = 0.4 b EBG - Tremor Psychiatry Lunch Rest 2 h 30 Compression H ₂ 4 m/n/m PO ₂ = 0.4 b EBG - Tremor Psychiatry Clinical Stop 2 h 30 Compression H ₂ 5 m/n/m PO ₂ = 0.4 b Sleep EBG EBG - Tremor Dinner 20.00 20.50 23.20	Light out Lights out
D ₅	Wednes. 08/05	06.30 07.40 10.10 12.00 14.30	400	2 h 30 Compression H ₂ 7 m/n/m PO ₂ = 0.4 b EBG - Tremor Psychiatry Breakfast Stop Lunch Rest	

comex

D	Dates	Chronology	Depth m	Data	Scientific Activities
D ₅	Wednes. 08/05	16.00 End of compression	450	$H_2 = 25.8$ b $H_e = 19.8$ b (43 %) $O_2 = 0.41$ b (0.89 %)	Psychometry Clinical Sleep EBG
D ₆	Thursd. 09/05	06.30 Wake up 08.00 Breakfast	450	$H_2 = 25.5$ b $H_e = 19.5$ b (42.3 %) $O_2 = 0.42$ b (0.92 %)	Bubble detection EBG - Tremor Psychometry Ophthalmology
		12.00 Lunch 14.30 Rest 19.00 Dinner		$N_2 = 0.05$ b (0.1 %)	Psychology Ophthalmology EBG - Tremor Clinical Sleep EBG
D ₇	Friday 10/05	06.30 Wake up 08.00 Breakfast	450	$H_2 = 25.6$ b $H_e = 19.5$ b (55.7 %) $O_2 = 0.44$ b (0.95 %)	Beginning of daytime urline taking EBG - Tremor Exercise in the dry
		13.00 Lunch 14.00 18.30 19.00 Dinner 20.00 22.00 Lights out			Exercise in the dry End of daytime urline taking/beginning of nighttime urline taking Clinical Sleep EBG

comex

D	Dates	Chronology	Depth m	Data	Scientific Activities
D ₈	Saturday 11/05	06.30 Wake up Breakfast	450	Bottom time H ₂ = 24.8 b (54 %) He = 19.7 b (42.9 %) O ₂ = 0.42 b (0.91 %) Switch to 30 % H ₂ 8 hrs stay	Blood sampling End of nighttime urine taking
		08.00			Bubble detection EBG - Tremor
		12.00 Lunch			Psychometry
		15.00 Rest			Bubble detection EBG - Tremor
		16.00	450	Switch to 0 % H ₂ PO ₂ = 0.4 b	Bubble detection EBG - Tremor
		17.00		Recompression : 10 m - 2 min/m	Bubble detection EBG - Tremor
		18.00	460	Stop - Breathing by mask He O ₂ (98/2)	Clinical Bubble detection
		19.00			
		20.00			Dinner
		22.00		Recompression : 6 m, then 4 m. PO ₂ increased up 0.6 b (1.2 %)	Clinical Bubble detection
		23.30	470	Stop	Sleep EBG
D ₉	Sunday 12/05	08.00 Wake up Breakfast	470		Clinical Bubble detection
		12.00 Lunch		Decompression 470 - 450 m at 120 min/metre PO ₂ = 0.5 b	Clinical
		19.00			Rest
		20.00			Dinner
		22.00	465		Lights out Sleep EBG

comex

D	Dates	Chronology	Depth m	Data	Scientific activities
D10	Monday	08.00 Wake up	458	Decompression (continuation) $PO_2 = 0.45 b$	EBG - Tremor
		12.00 Lunch			Bubble detection
		14.30 Rest			Bubble detection
		19.00 Dinner			Clinical
		20.00			EBG - Tremor
		22.00	453		Sleep EBG
D11	Tuesday	04.00	450	End of decompression $PO_2 = 0.4 b$	
		08.00 Wake up			EBG - Tremor
		08.00 Breakfast			Bubble detection
		12.00	450	On He O_2 $PO_2 = 0.4 b$	Psychometry
		14.30 Lunch			
		Rest			
		19.00			Psychometry
		20.00	450		Clinical
		20.00 Dinner			EBG - Tremor
		22.00 Lights out			Sleep EBG
D12	Wednes.	06.30 Wake up	450	On He O_2 $PO_2 = 0.4 b$	Beginning of daytime urine taking
	15/05	08.00 Breakfast			EBG - Tremor
		08.30			Exercise in the dry
		13.00			
		14.00 Lunch			

COMEX

D	Dates	Chronology	Depth m	Data	Scientific Activities
D12	Wednesday 15/05	18.30 Dinner 19.00 20.00 Lights out 22.00			Exercise in the dry EBG - Tremor Clinical End of daytime urine taking/beginning of night time urine ta- king Sleep EBG
D13	Thursday 16/05	06.30 Wake up 08.00 Breakfast 09.00 Breathing by mask He O ₂ 99/1 during 15 min. then He N ₂ O ₂ 83.4/15.6/1 during 30 min 10.00 Bubble detection 12.00 Lunch 14.30 Rest 19.00 Dinner 20.00 21.00 Beginning of O ₂ adds PO ₂ = 0.6 b 22.00 Lights out			Blood sampling End of nighttime urine taking EBG - Tremor EBG EBG : Psychometry O ₂
D14	Friday 17/05	00.00 FINAL DECOMPRESSION He O ₂ at 45 min/m PO ₂ = 0.6 b 07.30 Wake up	439		Sleep EBG

COMEX

D	Dates	Chronology	Depth m	Data	Scientific Activities
D ¹⁴	Friday 17/05	09.00 Breakfast 12.00 Lunch 14.30 Rest	433		Bubble detection EEG - Tremor
		19.00 Dinner 20.00 22.00 Lights out	424		EEG - Tremor Clinical Bubble detection Sleep - EEG
D ¹⁵	Saturday 18/05	07.30 Wake up 09.00 Breakfast 12.00 Lunch 14.30 Rest	408	Decompression (continuation) PO ₂ = 0.6 b	Bubble detection EEG - Tremor
		19.00 Dinner 20.00 22.00 Lights out	400		Ophthalmology EEG - Tremor Clinical Bubble detection Sleep EEG
D ¹⁶	Sunday 19/05	07.30 Wake up 09.00 Breakfast 12.00 Lunch 14.30 Rest	375	Decompression (continuation) PO ₂ = 0.6 b	Bubble detection EEG - Tremor
			368		

COMEX

D	Dates	Chronology	Depth m	Data	Scientific Activities
D ₁₆	Sunday 19/05	19.00 Dinner 20.00 22.00			EKG - Tremor Clinical Bubble detection Sleep EKG
D ₁₇	Monday 20/05	02.35		Decompression (continuation) PO ₂ = 0.5 b	Bubble detection
D ₁₈	Tuesday 21/05			Decompression (continuation) PO ₂ = 0.5 b	Bubble detection EKG - Tremor Sleep EKG
D ₁₉	Wednesday 22/05			Decompression (continuation) PO ₂ = 0.5 b	Bubble detection EKG - Tremor Sleep EKG
D ₂₀	Thursday 23/05			Decompression (continuation) PO ₂ = 0.5 b	End of EKG Bubble detection Tremor
D ₂₁				Decompression (continuation) PO ₂ = 0.5 b	Blood sampling - Urine Bubble detection Tremor
D ₂₂	Saturday 25/05			Decompression (continuation) PO ₂ = 0.5 b	Bubble detection Tremor

COMEX

D	Dates	Chronology	Depth m	Data	Scientific Activities
D ₂₃	Sunday 26/05		145	Decompression (continuation) ($PO_2 = 0.5$ b)	Bubble detection Tremor
D ₂₄	Monday 27/05	07.55	120	Decompression (continuation)	Bubble detection Tremor
D ₂₅	Tuesday 28/05		80	Decompression (continuation) $PO_2 = 0.6$ b	Bubble detection Tremor
D ₂₆	Wednesday		50	Decompression continues at 45 m/metre	Bubble detection Tremor
D ₂₇	Thursday 30/05	13.40	15	$1/V = 60$ m/metre $O_2 = 24$ %	Blood sampling - urine
D ₂₈	Friday 31/05	03.40	1	Recompression to 4 m on air, then decom- pression at 90 m/m	Pure O_2 by mask for A_1 and A_3
		03.51	4		
		11.30	0	<u>SURFACE</u>	

comex

D	Dates	Chronology	Depth m	Data	Scientific Activities
TEAM B (3 DIVERS)					
D ₄	Tuesday 07/05	21.00	0	Surface	Sleep - Divers without EBG electrodes
D ₅	Wednesday 08/05	14.00	0		EBG electrode faste- ning
		17.00			
		21.00	10	Confinement He O ₂ (80/20) after 6 flushing	Sleep EBG
D ₆	Thursday 09/05	06.30	10	Wake up	Beginning of daytime urine taking
		08.00		Breakfast	EBG - Tremor
		08.30			Exercise in the dry
		13.00		Lunch	
		14.00	10		Exercise in the dry
		18.30			EBG - Tremor
		19.00			Clinical
		20.00		Dinner	End of daytime urine taking/ Beginning of nighttime urine taking
		22.00		Lights out	Sleep EBG
D ₇	Friday 10/05	06.30		Wake up	Blood sampling
		08.00		Breakfast	End of nighttime urine taking
			10	Confinement He O ₂	Bubble detection
					PO ₂ = 0.4 b

COMEX

D ₇	Dates	Chronology	Depth m	Data	Scientific Activities
D ₇	Friday 10/05	12.00 Lunch 14.30 Rest	10	EEG - Tremor Psychometry Ophthalmology	EEG - Tremor Psychometry Ophthalmology
D ₈	Saturday 11/05	06.30 Wake up 07.30 Breakfast 19.00 Dinner 20.00 Lights out	10 0	Decompression from 10 to 5 m at 1 m/m, then from 5 to 0 m at 60 m/m. Total de- compression = 5.00 hrs Surface Compression He O ₂ (80/20) PO ₂ = 0.4 b after	Sleep EEG Bubble detection
D ₉	Sunday 12/05	21.00 Lights out	10	Compression He 2,5 m/m PO ₂ = 0.4 b	Sleep EEG
J ₁₀	Monday 13/05	02.00 Stop 05.00 Wake up 07.00 Breakfast	10 100	Beginning of compres- sion He at 2 m/m 2.30 hrs Compression He 2,5 m/m PO ₂ = 0.4 b	Sleep EEG EEG - Tremor Psychometry

COMEX

D	Dates	Chronology	Depth m	Data	Scientific Activities
D ₁₀	Monday 13/05	11.40 Stop 14.10 Lunch Rest	200	2.30 hrs Compression H ₂ 4 mln/metre PO ₂ = 0.4 b	EKG - Tremor Psychology EKG - Tremor Psychometry Clinical
		19.00 Dinner 20.00 20.50 Stop 23.20 Lights out	300	2.30 hrs Compression H ₂ 5 mln/metre PO ₂ = 0.4 b	EKG - Tremor Sleep EKG
D ₁₁	Tuesday 14/05	06.30 Wake up Breakfast 07.40 Stop 10.10 Lunch 12.00 Rest 14.30 End of compression	400	2.30 hrs Compression H ₂ 7 mln/metre PO ₂ = 0.4 b	EKG - Tremor Psychometry
		16.00 19.00 Dinner 20.00 22.00 Lights out	450	Arrival at the botton He O ₂ PO ₂ = 0.4 b	EKG - Tremor Psychometry Clinical Sleep EKG
D ₁₂	Wednesday 15/05	06.30 Wake up Breakfast 08.00	450	Bottom time	Bubble detection EKG - Tremor Psychometry Ophthalmology
				H ₂ = 25.1 b (54.6 %) He = 21.2 b (46 %) O ₂ = 0.4 b (0.86 %)	

COMEX

D	Dates	Chronology	Depth ^m	Data	Scientific Activities
D 12	Wednesday 15/05	12.00 Lunch 14.30 Rest	450	Psychology Ophthalmology	EEG - Tremor Clinical Sleep EEG
D 13	Thursday 16/05	06.30 Wake up 08.00 Breakfast 08.30	450	Bottom time H_2 He O_2 $PO_2 = 0.4 b$	EEG - Tremor Exercise in the dry (t = 33.5° C)
		13.00 14.00 Lunch			Exercise in the dry (t = 32.6° C) EEG - Tremor Clinical Sleep EEG
		19.00 Dinner 20.00 22.00 Lights out			
D 14	Friday 17/05	06.30 Wake up 08.00 Breakfast	450	Bottom time H_2 He O_2 $PO_2 = 0.4 b$	EEG - Tremor
		12.00 14.00 Lunch			
		16.50 18.45	450	Dive of B_1 , sphere 3, 1.55 hr water t = 31° C	Exercise in the wet

COMEX

D	Dates	Chronology	Depth m	Data	Scientific Activities
D ₁₄	Friday 17/05	19.00 Dinner 20.00 Lights out			EEG - Tremor Clinical Sleep EEG
D ₁₅	Saturday 18/05	06.30 Wake up 08.30 Breakfast	450	botom time H ₂ He O ₂ PO ₂ = 0.4 b	Beginning of daytime urine taking
		09.48 Dive of B ₂ , sphere 3, 2.00 hrs 11.48 Water t = 31° C			Exercise in the wet EEG - Tremor
		12.00 Lunch 14.30 Rest 16.20 Dive of B ₃ , sphere 3, 1.58 hr 18.18 Water t = 30° C	450		End of daytime urine taking/Beginning of nighttime urine taking EEG - Tremor Clinical Sleep EEG
		19.00 Dinner 20.00 Lights out		Ventilation He O ₂ Beginning of O ₂ adds PO ₂ = 0.5 b	
D ₁₆	Sunday 19/05	00.00 FINAL DECOMPRESSION	450		
		06.30 Wake up 08.30 Breakfast		H ₂ = 23.8 b (47.5 %) He = 22.5 b (48.9 %) O ₂ = 0.48 b (1.05 %) 1/V = 70 mln/m	Blood sampling End of nighttime urine taking EEG - Tremor Bubble detection
		12.00 Lunch 14.30 Rest	438		Bubble detection Optalmology EEG - Tremor Clinical Bubble detection
		19.00 Dinner 20.00 Lights out	430		Sleep EEG

COMEX

D	Dates	Chronology	Depth m	Data	Scientific Activities
D17	Monday 20/05	15.45 Dive	415	H ₂ Decompression (continuation) H ₂ = 44 ‰	Bubble detection EBG - Tremor
		16.23	408		t = 30° C
		10.23 Dive	399	H ₂ decompression (continuation) H ₂ = 42 ‰	B ₂ : Dive - 42 min
		11.05 Dive	395		water t = 30° C
		15.24 Dive	395		B ₁ : Dive - 28 min
		15.52			water t = 30° C
D19	Wednesday 22/05		388	H ₂ decompression (continuation) H ₂ = 41 ‰	Bubble detection EBG - Tremor
			367		Sleep EBG
D20	Thursday 23/05	16.57 Dive	352	H ₂ decompression (continuation)	B ₁ : Dive - 7 min
		17.04	350	H ₂ = 39 ‰	water t = 29° C
		19.52	350	1/V = 65 mln/m	
D21	Friday 24/05		335	H ₂ = 35 ‰	Bubble detection EBG - Tremor
					Sleep EBG
D22	Saturday 25/05		312	H ₂ = 32 ‰	Bubble detection EBG - Tremor
					Sleep EBG
D23	Sunday 26/05		300	1/V = 60 mln/m H ₂ = 29 ‰	Bubble detection EBG - Tremor
					Sleep EBG

COMEX

D	Dates	Chronology	Depth m	Data	Scientific Activities
D ₂₄	Monday 27/05		266	He = 22 %	Bubble detection EEG - Tremor Sleep EEG
D ₂₅	Tuesday 28/05	04.02	250	1/V = 55 mln/m	Bubble detection EEG - Tremor Sleep EEG
D ₂₆	Wednesday 29/05		215	H ₂ = 4 %	Bubble detection EEG - Tremor Sleep EEG
D ₂₇	Thursday 30/05		188	H ₂ = 2 %	Blood sampling - Urine
D ₂₈	Friday 31/05		162	H ₂ = 2 %	End of EEG Bubble detection Tremor
		17.05	157	Transfer into heliox atmosphere chamber H ₂ = 0 %	
D ₂₉	Saturday 01/06		136	He O ₂ decapsulation PO ₂ = 0.5 b 1/V = 55 mln/m	Bubble detection Tremor
D ₃₀	Sunday 02/06	21.20	100	PO ₂ = 0.6 b	Bubble detection Tremor
D ₃₁	Monday 03/06		83	PO ₂ = 0.6 b	Bubble detection Tremor

comex

D	Dates	Chronology	Depth m	Data	Scientific Activities
D ₃₂	Tuesday 04/06	19.05	50	Decompression (continuation) 1/V = 55 mln/m	Bubble detection Tremor
D ₃₃	Wednesday 05/06		30	Decompression	Bubble detection Tremor
D ₃₄	Thursday 06/06	03.10	15	1/V = 120 mln/m O ₂ = 24 %	Blood sampling
D ₃₅	Friday 07/06	09.55	0	<u>SURFACE</u>	Pure O ₂ by mask for B ₃

comex

PROFONDEUR
DEPTH MSW

500

450

400

300

200

100

0

3 4 5 6 7 8 9 10 11 12 13 14 15 16 17 18 19 20 21 22 23 24 25 26 27 28 29 30 31 1 2 3 4 5 6 7 8

M A I

M A Y

J U I N J U N E

A

B

H₂

H₂

HYDRA V HYDROX 450 msw 1985

PH₂
bar

11/1/85

10

20

30

HYDRAV

MEDICAL AND PSYCHOPHYSIOLOGICAL ASPECTS

X. FRUCTUS

Direction Scientifique, COMEX Marseille

INTRODUCTION

The doctors who participated in this experiment were not content merely to watch over the divers' health, which didn't give them much trouble, they were particularly interested in observing the functional and psychological states of these six men who were being subjected to new and different conditions of saturation diving. New and different, actually, by virtue of only one element, but one of great importance, the breathing mixture. With, however, the reassuring fact that the six HYDRA IV divers had breathed hydrogen-enriched mixtures at nearly the same partial pressure of hydrogen, give or take bar, as would be the maximum used in HYDRA V.

THE DIVERS

Prolonged exposure at 450 meters' depth (as against 430 for JANUS IV) would be familiar to 4 of the 6 participants (A1, A2, A3 and B2) who had a vivid memory of similar experimental conditions. In addition, diver A3 had breathed hydrox between 120 and 300 meters during HYDRA IV. As has been mentioned, the divers were divided into two groups of three.

Groupe A

	A1	A2	A3
Age (years)	40	35	34
Height in cm	189	183	176
Weight in kg	88	80	74
Skin surface (m ²)	2.15	2.02	1.90
Vital capacity (VC) in l _{BTPS}	6.32	5.53	6.25
FEV in l _{BTPS} · s ⁻¹	4.15	3.60	5.01

Groupe B

	B1	B2	B3
Age	32	31	34
Height in cm	175	179	172
Weight in kg	73	75	75
Skin surface (m ²)	1.89	1.94	1.88
Vital capacity (VC) in l _{BTPS}	5.60	5.40	4.77
FEV in l _{BTPS} · s ⁻¹	4.16	4.09	3.57

After three weeks of preparation (medical and physiological examinations, and training for tests) the 6 divers were in satisfactory physical condition. There were certain differences between the two groups. All three members of group A had sound experience in deep saturation diving. A2 and A3 (COMEX)

more than 400 days each on offshore oil sites, not to mention JANUS IV and the ENITEK experiments, and A1 (FRENCH NAVY) in experimental dives, especially ENITEK 5. Group B was more disparate : B1 (FRENCH NAVY) had a modicum of experience with saturation, B2 (COMEX) quite a bit more, with 150 days of deep water sites plus ENITEK 5, but it was virtually nonexistent for B3 (INPP). Be that as it may all six divers, who were of course volunteers, were very well motivated to participate in testing this promising new mixture and from the beginning to the end of their "immobile trip" the esprit de corps was excellent.

SYMPTOMATOLOGY

Here are the clinical observations of group A and group B recorded chronologically for the day (D), time (T) and depth in msw, with mention of breathing media.

<u>GROUP A</u>						
D	T	Depth (msw)	Observations	Divers		
				A1	A2	A3
1/3		10	He-O ₂ (80/20) <i>Sleep restless - Insomnia</i> <i>Discomfort</i>	-	-	
4	02:00		Beginning of compression (He) <i>Insomnia</i> <i>No comments</i>	-		-
	14:10	200	Compression continues (H ₂)			
5	07:40	400	Stop (PH ₂ 10 bars,)			
	10:10	400	Resumption of compression (H ₂)			
	12:00	416	<i>Feeling okay, especially note normal nasal respiration</i>	"	-	-
	16:00	450	(PH ₂ :25.8 bar. PO ₂ : 0.41 bar) <i>No perceptible HPNS</i> <i>Remarkable breathing comfort</i> <i>Narcose felt as degree 0.5 - 1</i> <i>Feels normal and no HPAS</i>	-	-	-
6		450	(PH ₂ : 25.5 bar. PO ₂ : 0.42 bar) <i>Slight fatigue at end of day</i>	-	-	
7		450	(PH ₂ : 25.6 bar. PO ₂ : 0.44 bar) <i>Very slight narcosis, not perceptible</i> <i>Nothing else to report</i>	-	-	-

D	T	Depth (msw)	Observations	A1	A2	A3
8	08:00	450	Switch to 30 % H ₂ (PH ₂ : 13.8 bar) <i>Slight nasal obstruction</i> <i>Onset of distal tremor</i>	-		-
8	16:00	450	Switch to 0 % H ₂ (PO ₂ : 0.4 bar)			
	17:00	450	<i>Strong nausea/ Pale. Anxiety</i> <i>Intense fatigue, had to lie down</i> <i>Nausea. Dizziness (without nystagmus)</i> <i>Pruritis</i> <i>Tremor</i>	-	-	-
			10 m compression at 2 min/meter			
	18.15	460	2 % O ₂ mixture by mask			
	18:40	460	O ₂ by mask stopped <i>Vomiting, dizziness</i> <i>Hyperbaric Arthralgia (or bends) in knees, wrists, shoulders ([±]all over)</i> <i>Rash with acute niggles, all over, irritating (resumed mask)</i> <i>Took 1 g of Aspegic</i> <i>Attenuation of shock but intense fatigue and persistent polyarthralgia</i> <i>Niggles nearly unbearable, agitated, took 6 mg of Polaramine</i>	-	-	-
	20:30	460	Meal more or less eaten, due to sporadic nausea, but no vomiting. Marked fatigue.	-	-	
	21:30	460	Resumed 2 % O ₂ by mask. <i>Precordialgia. Tachycardia → 2 % O₂ by mask stopped</i> <i>Breathing by mask terminated</i> <i>1 Valium tablet 5 mg</i>	-	-	-
	22:20	460	<i>Exacerbation of itching and prickling, and arthralgia of the right shoulder</i>			
8	22:20	460	Still on heliox, but PO ₂ = 0.6 bar			
	23:00	460	Beginning of compression to 470 m			
	23:25	470	<i>Fatigue, chills, drowsiness. Niggles more intense at meals, during muscular effort and when warm.</i>	-		-

D	T	Depth	Observations	A1	A2	A3
9	00:30	470	Everything fairly quiet. Sleeping	-	-	-
	09:40	470	5 mg Valium Valium and Polaramine	-	-	-
	10:00	470	Pruritis, slight vertigo, Romberg negative General condition becomes normal ... or remains normal.	-	-	-
	12:00	470	Decompression to 450 m starts, at 2 hrs/m	-	-	-
	19:00	466	Otitis externa : Polydexa Valium 5 mg H.A. which will disappear in 4 days	-	-	-
10	08:00	458	Slight tremor. Moderate nasal obs- truction. Some muscular twitching	-	-	-
11-12		450	Exercises carried out in the dry, Form rather mediocre.	-	-	-
13	09:00	450	Trimix with 15.6 % N ₂ breathed	-	-	-
	11:00	450	for 30 mins. This test reported as unpleasant by the divers, causes a degree 3 narcosis. Form rather mediocre	-	-	-
14	00:00		Beginning of final decompression with PO ₂ of 0.6 bar to 350 meters	-	-	-
17	02:35	350	PO ₂ 0.5 bar Nothing to report	-	-	-
24	07:55	120	PO ₂ 0.6 bar	-	-	-
27	13:40	15	PO ₂ 24 %	-	-	-
28	03:40	1	Pains in the knees : pure O ₂ by mask	-	-	-
	03:51	4	Recompression to 4 m, then recompres- sion at 90 min/m. Pain relieved	-	-	-
11:30		0	Divers leave chamber. Condition satisfactory	-	-	-

GROUP B

D	T	Depth (msw)	Observations	Divers		
				B1	B2	B3
5/7		10	He-O ₂ (80/20) <i>Sleep mediocre, improving second night</i>	-	-	
10	02:00		He compression starts <i>Sleep intermittent</i>	-	-	-
	14:10	200	Compression continues on H ₂			
11	07:40	400	Stop. (PH ₂ 10 bars)			
	10:10	400	Compression resumes on H ₂ <i>Slight transient HPAS (wrists)</i>	-	-	
	12:00	416	<i>Cutaneous hypesthesia</i> <i>Impression of pitching when moving about. Romberg negative</i> <i>Great ease of breathing</i> <i>Average narcosis degree 1 to 2</i>	-	-	-
	16:00	450	PH ₂ : 25.1 bar; PO ₂ = 0.4 bar <i>No perceptible HPNS or HPAS</i> <i>Remarkable breathing comfort</i> <i>Does not have the impression of beeing at 46 ATA</i> <i>Cutaneous hypesthesia (hypalgesia)</i> <i>At times, visual impression of pitching</i> <i>Tendency towards mind wandering</i> <i>Memorization difficulty</i> <i>On the average, narcosis level 2</i>	-	-	-
12		450	PH ₂ : 25.1 bar; PO ₂ = 0.4 bar <i>Form average. Pitching sensation has disappeared</i> <i>Cutaneous hypesthesia persists</i>	-	-	-
13		450	<i>Difficulty in conforming to the dry test requirements. Hypesthesia persits</i>	-	-	
14		450	<i>Wet tests well tolerated</i>	-		
15		450	<i>Wet tests well tolerated</i> <i>The slight narcosis tends to lessen and in any case never affected professional behavior</i>	-	-	-

D	T	Depth (msw)	Observations	B1	B2	B3
16	00:00	450	Beginning of final decompression by gradually eliminating the H ₂ (PO ₂ = 0.48 bar)			
17/22			Continues at rate of 70-65 min/meter			
23	02:02	300	PH ₂ = 9 bar. Decompression 60 Min/meter <i>Feeling normal again and in fine fettle</i>	-	-	-
28	17:05	157	Transfer into pure heliox (PH ₂ = 0 ; PO ₂ = 0.6 bar) - 55 min/meter			
34	09:00	12	<i>Slight pain in knees and calves, relieved by inhaling pure O₂ by mask</i> (15 m - 0) : 120 min/m)			-
35	09:55	0	Divers leave chamber. <i>Condition satisfactory</i>	-	-	-

These observations, which we have necessarily summarized, albeit as faithfully as possible, in order not to become submerged in details, are above all subjective. They have been taken from the sheets filled out once or twice a day by the divers (see attached models) and completed by our own observations through the viewports or by intercom. Clearly the discussion concerning these results should be centered on the two main themes of the experiment, hydrogen narcosis and HPNS.

NARCOSIS

The data gleaned from the HYDRA IV experiment permitted us to draft a fairly complete but shaded description of the psychodysleptic effect of hydrogen and to establish a scale of the degrees of narcosis - a simple, not a descriptive, scale, relating to the different levels of sensations felt and to alteration in behavior. Here is this scale as it was published at the 10th E.U.B.S. Congress in Marseilles in October 1984 :

DEGREES OF NARCOSIS

- 0 - Not perceptible
- 1 - Barely perceptible
- 2 - Slight but controllable
- 3 - Pronounced and capable of affecting behavior
- 4 - Incapacitating, in process of evolution and dangerous

The markers exist therefore, those touchstones so indispensable for evaluating, with a precision necessarily relative but quite adequate, the effects of the PH_2 as a function of the P *per se*

Care must be taken not to disregard the original aspects of this narcosis, those which differentiate it fairly clearly from the "rapture of the deep" of air diving. The following is a qualitative break down of the effects observed during HYDRA IV when the PH_2 was highest, at 240 msw.

HYDROGEN NARCOSIS

DIVERS : 6 - DEPTH : 240 msw - P_{H_2} : 24,5 bar

	No of Affected divers (out of 6)
<u>1 - SENSORY HALLUCINATIONS</u>	
Gustative : taste of metal or chlorine	2
Auditory : sounds more intense, sometimes indistinct	3
Visual : light, more vivid (dazzling) colours tending towards orange	3
Tactile : cutaneous hypoesthesia, \pm diffused hyperesthesia of the fingers	4 1
<u>2 - SOMESTHESIC HALLUCINATIONS</u>	
A - At exercise	
Diffused warm flushed feeling	3
Easy muscular effort, without fatigue	4
B - In R.S.R. position*	
Disorientation, vertigo (sometimes nausea)	3
Distortion or loss of sense of bodily arrangement	3
<u>3 - INTELLECT AND BEHAVIOUR</u>	
Mental dispersion. Interior dialogue	2
Instability : agitation or impairment of alertness	3
<u>4 - AFFECTIVE COMPONENTS-</u>	
Impression of increased muscular strength and endurance	3
Variable euphoria or well-being	3
Displeasure : anxiety of losing self-control	2
<u>5 - OTHER EFFECTS</u>	
Tendency towards drowsiness	2
Breathing lapses	1

(DEGREES OF NARCOSIS : 1 to 3 +)

* R.S.R. = Relative Sensory Rest

This symptomatology indicates properties close to those of anesthetic and/or hallucinogenic drugs. In this connection, D. Lamy of CEPISMER drew up the following list of questions and answers after analysing the impressions of the six divers under the influence of more or less perceptible narcosis but not more than degree 2 or 2+ (this at 450 m with a P_{H_2} of 25.3 ± 0.5 bar) :

Is hydrogen ...

Hypnotic ? No : Nocturnal sleep fair to good,
No diurnal drowsiness

Tranquillizing ? Yes : Subjects self-confident,
serene, cooperative

Anxiety-relieving ? No : (But not anxiety producing,
either)

Neuroleptic ? Yes : Decline in motor activity (relaxed)

Analgesic ? Yes : No muscular or articular pains during
exertion,

Impression of tirelessness

Blows and wounds felt very little

Sensory ? Yes : Hyperacusia at times disagreeable

In addition, some slowing down of mental processes with
an incorrect notion of time elapsed

Personal variations are less pronounced than interpersonal differences and very likely one cannot attribute to these variations the contrast observed in one diver (L.S.) exposed to ostensibly the same P_{H_2} but at different depths, in HYDRA IV and HYDRA V.

CASE OF DIVER L. S.				
EXP.	DEPTH MSW	PH ₂ BAR	SYMPTOMS	GRADE OF NARCOSIS
<u>HYDRA IV</u>				
	120	12.7	Decline in digital tactile sensitivity	.5
	180	18.6	Slight narcosis perceptible in R.S.R.*	1
	240	24.5	Cutaneous hyperesthesia. Hyperacusia. Controlling action requires great mental effort, anxiety-producing. During routine activity subject feels more himself. Decline in alertness during R.S.R.	3
	300	22.9 (trimix)	Same symptoms as at 240 m, but attenuated	2
	300	18.3 (trimix)	Narcosis barely perceptible	
	150	15.7	(Decompression stop). Nothing to report.	
<u>HYDRA V</u>				
	450	25.8	Nothing to report	0
	450	11.5	Nothing to report	0
	450	0.0	Onset of tremor Arthralgia (knees, shoulders)	HPNS H.A.

Our rough calculations for HYDRA IV of the relationship between the ambient pressure, the gas pressure and the degree of narcosis had led to the prediction that for every additional 100 m after the 200 msw depth, the PH₂ of 17 bars easily tolerated at 165 meters could be increased by 2 bars.

On the basis of this hypothesis we reckoned that at 450 m the HYDRA V divers would be able to tolerate a mixture containing 50 % H₂. To simplify matters it was decided to set the "hydrogen depth" at 250 m. This led to an H₂-He-O₂ trimix with 54 % hydrogen and a PH₂ which was fairly well maintained at the bottom of 25.3 bars \pm 1 %. At the planned PH₂ of 23 bars the level of narcosis would probably not have exceeded degree 1 for all six divers, but we would have had greater difficulty in evaluating the limits.

The consistency of the results would appear to point to the existence of a pressure reversal effect. But this is probably not the only factor which accounts for the hydrogen tolerance at 450 m -- another, partial, explanation could be the gradual increase in PH₂ from 250 m on over a 26-hour period, a factor which must also be taken into consideration. And isn't it also the

case for the H.P.N.S. which slow compression delays and attenuates ?

A more rapid transition from 0 to 25 bars of H_2 at the same depth would no doubt have enabled us better to assess the role of each factor. We had envisaged this, but in view of the pathological disorders which team A experienced during the reverse changeover, we decided against it.

If countereffect of PH_2/P per se in human beings is not definitively proven, the reverse effect, P per se/ PH_2 , no longer appears to be in doubt after observing the condition of the divers in the HYDRA V experiment. Four of the six had participated in experimental saturation tests between 450 and 610 msw with a compression profile down to 46 bars identical to the curve for HYDRA V.

H.P.N.S.

None of the six divers had HPNS symptoms in the 300-meter zone. Nor did they at 450 m on hydrogen. The now familiar clinical picture of HPNS was totally absent. No tremor, no asymmetry, nor - prior to myoclonia - the tenseness and febrility so characteristic of this syndrome. Normal nasal respiration, thus absence of dysphagia, retention of appetite and an insignificant weight loss (1,6 kg on the average for team B which remained on hydrogen trimix throughout, from 200 m going down to 200 m going up. Another remarkable phenomenon, was the complete absence of high pressure articular syndrome (H.P.A.S.), or the "no joint-juice syndrome".

This was such a contrast with what the veteran divers had experienced during deep saturation dives on heliox or nitrogen trimix that in spite of the discomfort of their spherical chamber and the constraint of confinement (including the background noise of a new environmental control system), good spirits - due also perhaps to a slight narcosis - were a socio-psychological constant of the H_2 -He- O_2 saturation.

GAS SWITCH

But team A, after 2 1/2 days on hydrox, was switched to pure heliox while still at 450 m. The hydrogen was withdrawn in two stages with an 8-hour stop on an intermediate mix with 30 % H_2 . Despite this precaution, in the hour following the switch to pure heliox divers A1 and A2 had a sudden onset of HPNS with tremor, vertigo, nausea, agitation, anxiety and fatigue, A1 having the most pronounced symptoms (cf. analytic table of symptoms, p. 4 - 2). This critical phase of the syndrome was attenuated during the night under the combined effects of diazepam and sleep (a sleep rendered easier by the comfort of the bunks in a much larger chamber than team B's). And this in spite

of additional compression of 20 meters in stages, between 17:00 and 23:00. More about this later.

As for HPAS, or no joint juice syndrome, it was literally explosive, affecting nearly all of the joints, which were painful even at rest and caused apprehension lest this be associated with osteo-articular bends.

ISOBARIC COUNTERDIFFUSION.

If, in spite of the HPNS, we decided to further compress 2 bars, it was because of the clinical manifestations of the isobaric counterdiffusion phenomenon, which we could not doubt, regardless of certain ambiguities : Doppler ultrasonic detection revealed a high number of circulating bubbles. For example, 1 hour and 20 minutes after the gas change A1 had degree 1 at rest and A2, the most severely affected, 3+ ! After 5 hours A2 still had degree 2 at rest (cf. G. Masarel, Ch. 9, p.5). And A2's vertigo was suggestive of a labyrinthine accident, albeit apparently without nystagmus.

But one articular pain could conseal another, caused by bubbles, especially in A2 and A3. Finally, the generalized rash with niggles and itching with which A2 was afflicted confirmed a counterdiffusion pathology.

The rest of the time on heliox was characterized by decreasing H. A. and stabilization of the HPNS symptoms.

DECOMPRESSION

The heliox decompression of team A following a well-tested procedure went off without incident until the very last meter, almost at the surface, when the pains in both knees felt by A3 were relieved by recompression to 4 meters, pure oxygen via mask and a slow-down in decompression up to the surface (90 minutes per meter).

The decompression of team B on hydrox with a decreasing hydrogen content to 0 at 200 m was a "first", with all of the uncertainties that any innovation in this domain can entail. No doubt too slow at the beginning, the compression brought the three divers back to the surface without any particular incidents except for some arthromyalgia in the lower limbs felt by B3 at 12 m and dissipated by two sessions of pure oxygen by mask.

CONCLUSION

The men in team A spent nearly 27 days in their hyperbaric chamber, and team B nearly 29 days. None of them suffered from exceptional fatigue given the conditions of prolonged confinement at 450 meters' depth.

Besides, the diminutions in weight were rather small : on an average, 2.5 kg in team A; 1.6 kg in team B.

The "recovery" time was variable and related to multiple factors.

One last remark : we are not sure that these experimental saturation dives are less trying for the participants than operational dives, for during HYDRA V it was once again evident that the exercises and tests of all sorts to which the divers were submitted left them too little free time and refreshing rest.

REFERENCES

- Brauer R.W., Way R.O.. Relative narcotic potencies of hydrogen, helium, nitrogen and their mixtures. J. Applied Physiol. 1970; 29 : 23-31.
- Brauer R.W., Hogan P.M., Hugon M., Macdonald A.G. and Miller K.W.. Patterns of interaction of effects of light metabolically inert gases with those of hydrostatic pressure as such - a review. Undersea Biomedical Research 1982; 9 : 4 - 353
- Carlioz M., Gardette-Chauffour M.C., Rostain J.C., Gardette B.. Hydrogen narcosis : a psychometric and neurophysiological study. EUBS Proceedings - Xth Meeting - Marseille (France), October 1984.
- Edel P.O., Holland J.M., Fischer C.L. and Fife W.P.. Preliminary studies of hydrogen-oxygen breathing mixtures for deep-sea diving. Proc. of "the working diver symposium". Marine technology Society 1972; 257-270.
- Fructus X., Gardette B., Carlioz M., Giran Y.. Hydrogen narcosis. Proceedings - Xth meeting EUBS, Marseille (France), October 1984.
- Gardette B. Gortan C., Carlioz M., Fructus X.. Hydrogen : a new gas for human deep diving. Proceedings, Xth meeting EUBS, Marseille (France), Oct. 84.
- Lambertsen C.J. et Bornmann R.C.. Isobaric inert gas counterdiffusion - 22nd UMS workshop - - UMS - Bethesda, 1979.
- Ornhaugen H.. Hydrogen-oxygen breathing at 1.3 MPa N.D.R.I. Stockholm, October 1984.
- Rostain J.C.. L'effet des hautes pressions avec divers mélanges gazeux chez le singe *Papio papio*. 1973 - Thèse de Doctorat, Marseille (France)

« THIS DOCUMENT IS THE PROPERTY OF COMEX, all information contained herein may neither be reproduced, used, disclosed, transmitted nor in any way made public without the written permission of the owner. any person in possession of this document acknowledges being bound by the obligation to treat it as confidential. »

APPENDICES

HYDRA V

NOM : LANGOUET Yves

DATE : 14.05.85
le matin

B2

FICHE D'AUTO-OBSERVATION
(à remplir tous les jours, entre 17 et 19 heures)

Heure du coucher : .22⁰⁰ Heure du réveil : ..06⁰⁰ SIESTE ?

Qualité du sommeil nocturne : Bon / médiocre / intermittent / mauvais /

Rêves :

Perception subjective de la forme

Matin : Soir :

Excellente _____ : _____
Bonne ⊗ _____ : _____
Moyenne _____ : _____
Médiocre _____ : _____
Mauvaise _____ : _____

Gêne et douleurs articulaires au mouvement

A gauche : A droite

Epaule _____ : _____
Coude _____ : _____
Poignet ✓ _____ : ✓ _____
Genou _____ : _____
Cheville _____ : _____

Appétit : Bon.

Obstruction nasale : neant.

ETAT PSYCHIQUE

EVALUATION DU S.N.H.P.

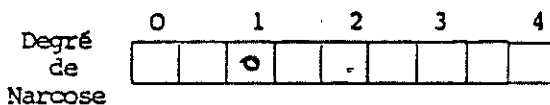

Impression générale : La narcose à l'hydrogène n'a rien de comparable avec celle de l'azote elle n'est pas du tout euphorique. mais a tendance à diminuer les sensibilités nerveuses, (tel le toucher et le piquer)

Analyse :

En position assise ou couchée, tout va pour le mieux mais du tanguage apparaît au premier déplacement. Grande aisance respiratoire. ainsi qu'aucune gêne dans les déplacements.

Réservé
au
Correspondant

Heures : 6 12:50
Profondeurs : 380 m ≈ 400 m
Mélanges : H2 depuis 200 m

J //

« THIS DOCUMENT IS THE PROPERTY OF COMEX. all information contained herein may neither be reproduced, used, disclosed, transmitted nor in any way made public without the written permission of the owner. any person in possession of this document acknowledges being bound by the obligation to treat it as confidential. »

HYDRA V

NOM : LANGOUET Yves

DATE : 14.05.85

B2

le soir

FICHE D'AUTO-OBSERVATION
(à remplir tous les jours, entre 17 et 19 heures)

Heure du coucher : Heure du réveil : SIESTE ? NON...
Qualité du sommeil nocturne : Bon / médiocre / intermittent / mauvais /
Rêves :

Perception subjective de la forme

Matin : Soir :

Excellente :
Bonne :
Moyenne :
Médiocre :
Mauvaise :

Gêne et douleurs articulaires au mouvement

A gauche : A droite

Epaule :
Coude :
Poignet neant : neant
Genou :
Cheville :

Appétit : moyen.

Obstruction nasale : —

ETAT PSYCHIQUE

EVALUATION DU S.N.H.P.

Degré de Narcose

0	1	2	3	4
	●			

Impression générale :

Après cette journée à 450m on ressent une légère fatigue malgré le manque d'exercices. ~~de la journée~~ En fin de journée la sensibilité dormitive est toujours aussi atténuée. Mais le langage ne perd pas presque plus au moment du coucher.

Analyse :

Aucune fatigue cardiaque ou respiratoire après cette journée tout comme on pouvait le ressentir avec l'héliox. On n'a nullement l'impression de se trouver dans un "ligasse" ou "caisson" et sous pression. Mise à part la méditation qui paraît de la parole, il est difficile d'affirmer que l'on est à 450m.

Réservé

au

Correspondant

Heures :

Profondeurs :

Mélanges :

d' 16 h auvés à
450 m sous 54% H₂

J //

HYDRA V

NEUROPHYSIOLOGICAL STUDIES

J.C. ROSTAIN (1), M.C. GARDETTE-CHAUFFOUR (1)
R. NAQUET (2)

(1) GS de Physiologie Hyperbare, CNRS
Faculté de Médecine Nord
Boulevard P. Dramard
13326 MARSEILLE Cedex 15

(2) Laboratoire de Physiologie Nerveuse, CNRS
91190 GIF SUR YVETTE

I - INTRODUCTION

Fifteen years ago, hydrogen-oxygen mixture experiments in monkey have shown contradictory results. Brauer and Way (1970) reported an attenuation of HPNS, but Rostain and Naquet (1972) did not find in baboon *Papio papio* significant changes between HPNS in helium-oxygen mixture and HPNS in hydrogen-oxygen mixture.

Few years later, the study of the effect of helium-nitrogen-oxygen in monkey (Rostain et al. 1978, 1984 a,b) have shown that the addition of nitrogen improved some symptoms of HPNS under several conditions. From these studies, it appeared that nitrogen did not reduce HPNS if the speed of compression of 200 msw/h was used.

Consequently, with hydrogen-oxygen, the use of compression speed of 200 msw/h was probably too rapid and traumatic, to have a significant effect of hydrogen on the symptoms induced by such rate of compression and the use of hydrogen in diving become again interesting :

- low density of the mixture compared to helium or helium-nitrogen-oxygen mixture ;
- narcotic potency which might reduce some symptoms of HPNS.

New investigations were carried out with hydrogen to study the effect of this gas in pressure, but at this time in man. A primary neurophysiological study was performed during HYDRA IV experiment. This study shown that electroencephalographical (EEG) changes were similar to those recorded with helium-oxygen mixture ; only the decrease in the power of alpha waves was more intense when divers breathed the mixture with hydrogen.

II - METHODS

The tremor was measured with an accelerometer "minor tremor pick up" MT 3T of Nihon Kohden (1-100 Hz) placed on the middle finger of the dominant hand. The measurements were performed with the arm extended horizontally from the body (épreuve du serment) during three epochs of 20 seconds, each repeated several times per day at the same hours. The signals were analysed on line with a LSI 11/02 microcomputer (PLESSEY

Micro II) and were recorded on analogical magnetic tape... The analysis gave the mean amplitude of the tremor, the power spectra and the frequency. The results were stored on floppy disk and were plotted on printer. The curve was visualized on VT 105 monitor. They were expressed as percentage difference from control values. The final curve for each diver was plotted on digital table (BENSON).

The EEG activity was recorded from electrodes made of platinum wires fixed on the skull for all the duration of the experiment. They were implanted on fronto polar, central, mid temporal and occipital positions of the right hemisphere. The recordings were performed several times a day at the same hours on an electroencephalograph and on analogical magnetic tape by twin bipolar leads (fronto polar-central, central-mid temporal, mid temporal-occipital) simultaneously in all the subjects of each group. The magnetic tapes were processed by computer (LSI 11/23 DIGITAL) in order to obtain the power spectra. The results were calculated for each frequency band :

- delta : 1- 4c/s
- thêta : 4- 7c/s
- alpha : 8-14c/s
- beta 1 : 14-22c/s
- Beta 2 : 22-40c/s

The curves of the evolution of the power of each frequency band expressed as percentage difference from control values were plotted on digital table (BENSON).

The sleep EEG recording were preformed every night during pre-dive and dive. For this study the subjects put two skin electrodes around the eyes which were maintained in place with sparadrap for the night. The EEG of sleep were interpreted and the data computerized (DIGITAL LSI 11/23) to obtain occurrence, duration and percentage repartition of the stages of sleep and the hypnogram.

The statistical results were calculated for a group of subjects in the same situation (means obtained from the sleeps of pre-dive and means obtained from the sleeps at 450 msw) to avoid individual variations.

III - RESULTS

1°) HYPERBARIC TREMOR

- GROUP A

The compression to 450 msw with a total time of 38 hours did not induce increase of tremor. The tremor was not observed during the stay at 450 msw in hydrogen-helium-oxygen mixture (fig. 1).

The shift to He-O₂ mixture induced tremor which persisted during all the stay at 450 msw without hydrogen and during decompression until 200 msw ; it disappeared after this depth.

The comparison of the amplitude between the stay in mixture with hydrogen and the stay in mixture without hydrogen, shown an increase of tremor only with helium-oxygen mixture which was between 50 and 100% (fig. 2). The Mann Whitney U-Test gave no difference between the amplitude at the surface and the amplitude with hydrogen-helium-oxygen mixture. The difference was significant between the signal recorded at the surface and the tremor recorded during the stay in helium-oxygen mixture (fig. 3) ; the difference was also significant between data obtained with the two different mixtures at 450 msw (fig. 3).

The analysis of tremor during the shift from H₂-He-O₂ to He-O₂ mixture gave interesting data.

The rapid shift from 54% to 30% induced an increase of tremor, which appeared in all the subjects with different latencies (fig. 4). The second switch from 30% to 0% of hydrogen induced a new increase at least in two subjects (fig. 4).

- GROUP B

With the team B, the increase of tremor was not significant at least in two subjects during compression and stay at 450 msw (fig. 5). In one subject (B3), the tremor increased the second day of the compression (150%). This increase disappeared the first day at 450 msw and the tremor did not reappear during the stay at 450 msw with H₂-He-O₂ mixture (fig. 5).

HYDRA 5 - TREMOR

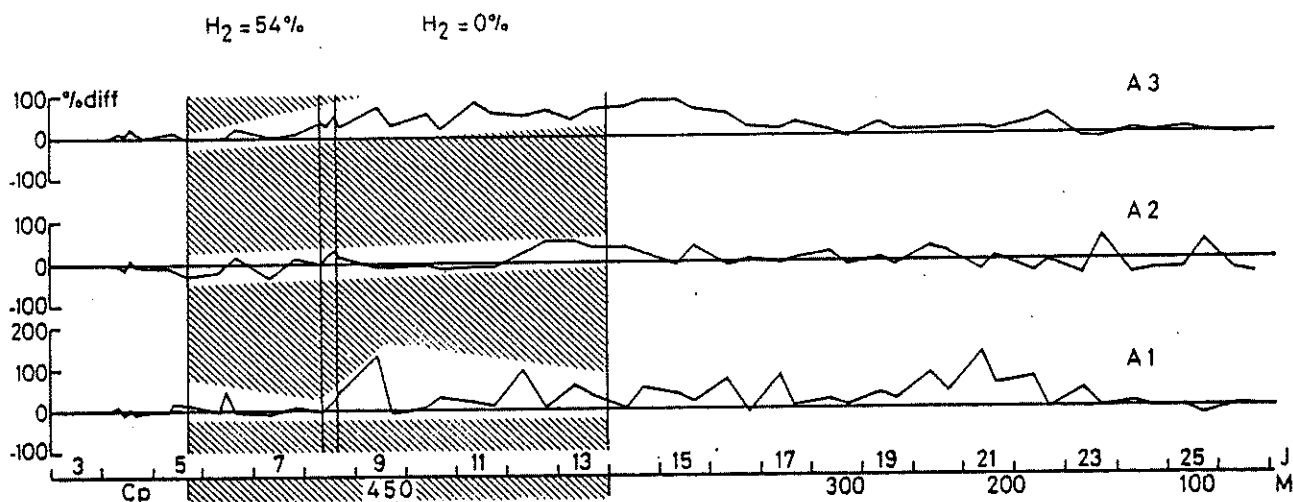

Figure 1 :

Evolution of the middle finger tremor of the three subjects of team A during the dive HYDRA V.

The increase is expressed as percentage difference from control value for the subjects A1, A2 and A3 from bottom to top. The shaded portion represents the stay at 450 msw. The two vertical lines inside the shaded zone represent the shift from 54% to 30% and from 30% to 0% of hydrogen.

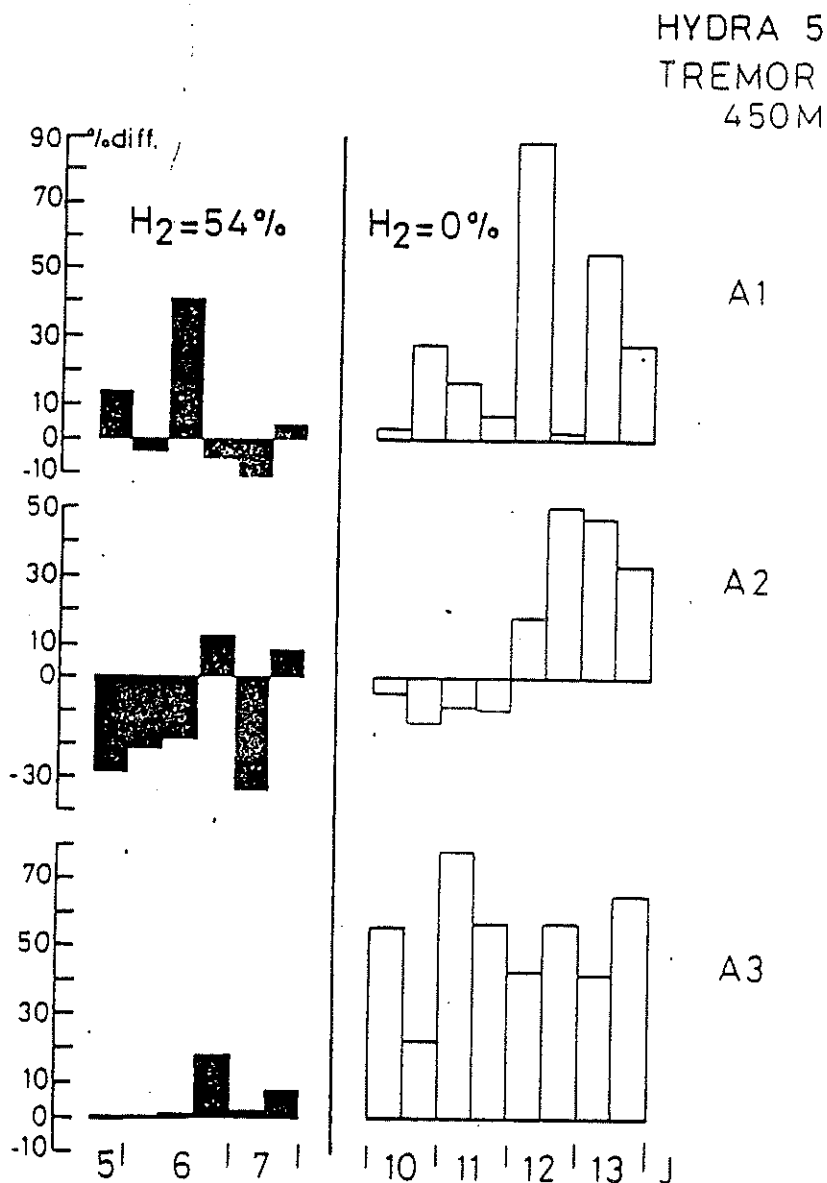

Figure 2 :

Evolution of the increase of the middle finger tremor expressed as percentage difference from control value during recording performed at 450 msw in H₂-He-O₂ mixture (H₂=54%) from day J5 to J7 and in He-O₂ mixture (H₂=0%) from day J10 to J13.

The subjects are put from top to bottom.

HYDRA 5
TREMOR
450M

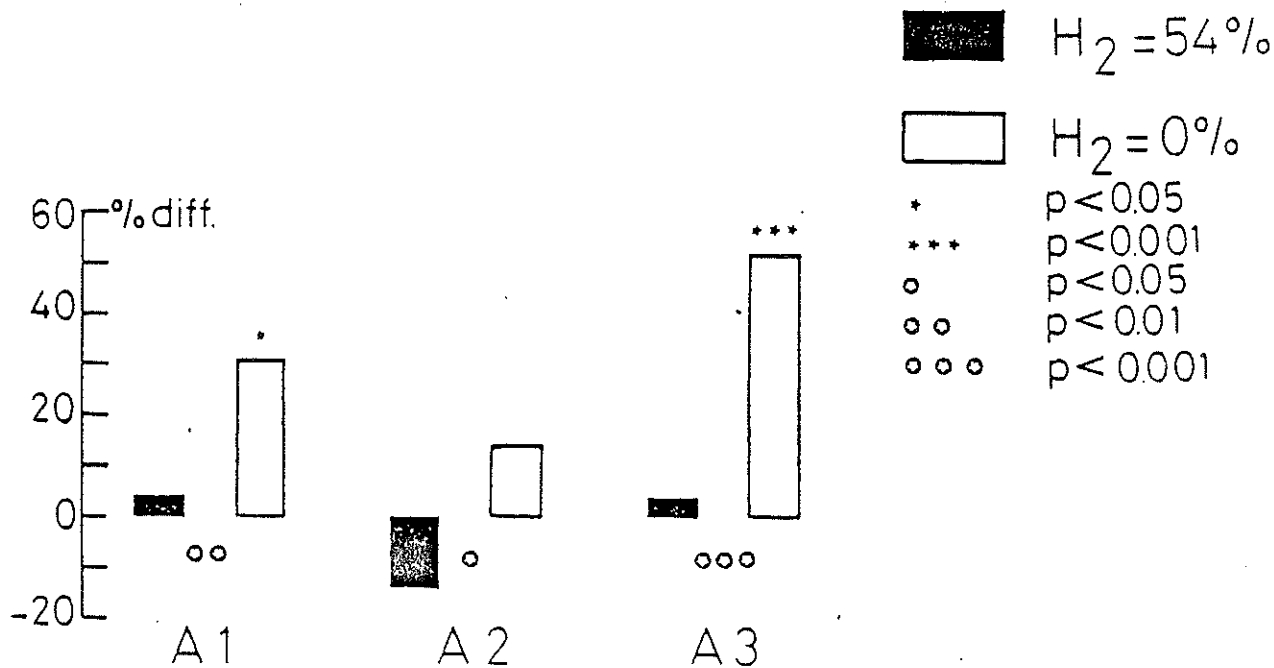

Figure 3 :

Middle finger tremor during the stay at 450 msw before and after the change of mixture. The results represent the mean calculated for the data obtained the days J6 and J7 with the H₂-He-O₂ mixture and for the data recorded during the days J10 to J13 with He-O₂ mixture.

The increase of tremor is expressed as percentage difference from control value for each subject. The U-test of Mann Whitney is significant between the values obtained with He-O₂ mixture and the values obtained at the surface (black stars) and the values obtained with H₂-He-O₂ (white stars). The difference is not significant between the values recorded in H₂-He-O₂ mixture and the surface.

« THIS DOCUMENT IS THE PROPERTY OF COMEX, all information contained herein may neither be reproduced, used, disclosed, transmitted nor in any way made public without the written permission of the owner. any person in possession of this document acknowledges being bound by the obligation to treat it as confidential ».

« THIS DOCUMENT IS THE PROPERTY OF COMEX, all information contained herein may neither be reproduced, used, disclosed, transmitted nor in any way made public without the written permission of the owner, any person in possession of this document acknowledges being bound by the obligation to treat it as confidential. »

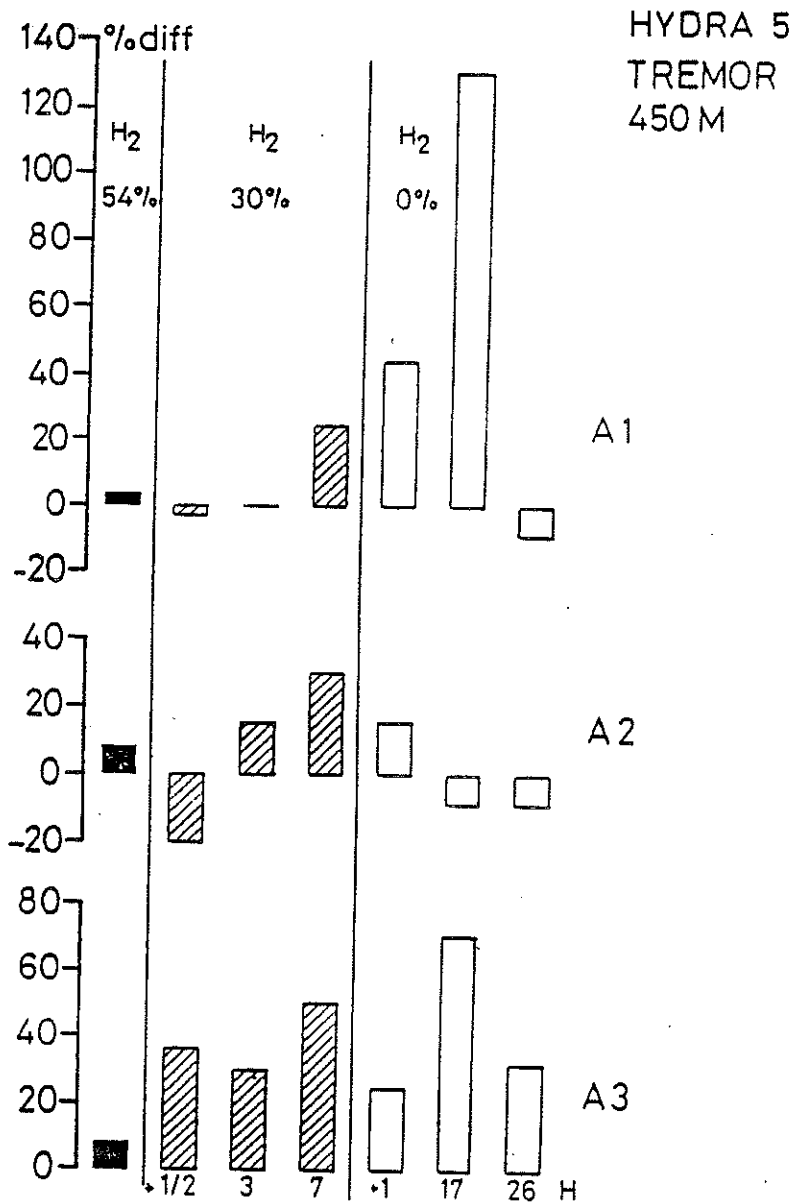

Figure 4 :

Middle finger tremor during the change of the mixture. The increase is expressed as percentage difference from control value.

The subjects A1, A2 and A3 are represented from top to bottom. The increase of tremor with 54% of hydrogen is represented on the left ; the increase of tremor 30 min, 3 hours and 7 hours after the shift to 30% of H₂ is represented on the middle ; the increase of tremor, 1 hour, 17 hours and 26 hours after the shift to 0% of hydrogen is represented on the right of the figure.

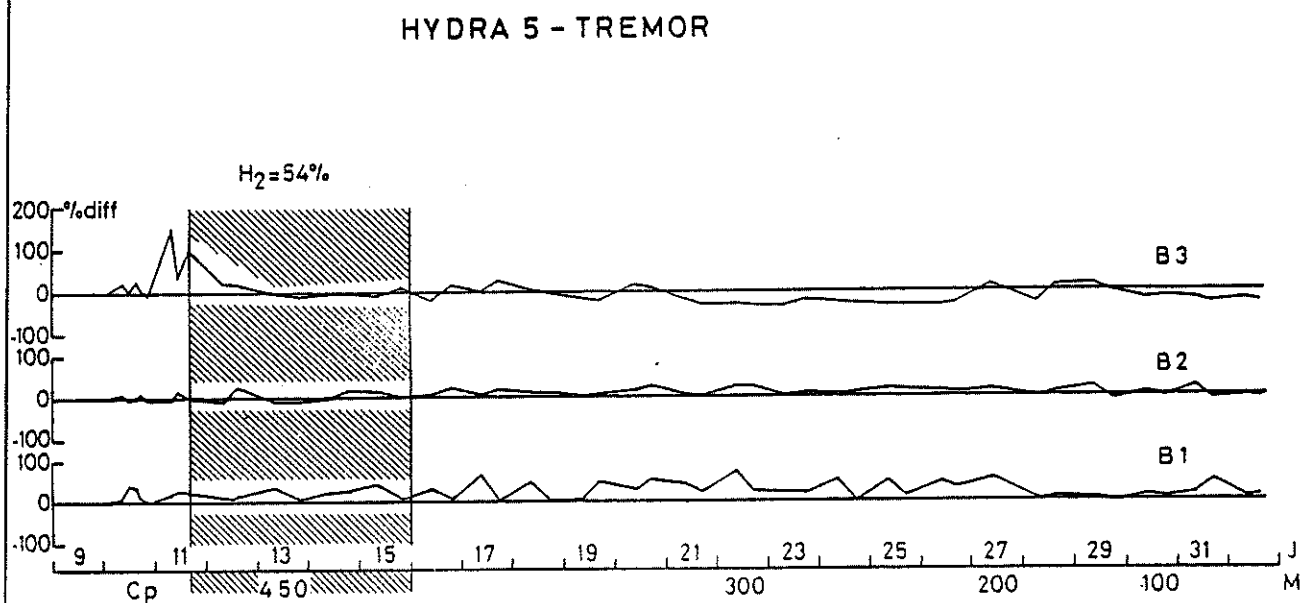

Figure 5 :

Evolution of the middle finger tremor of the subjects of group B during the dive HYDRA V.

(For legend see figure 1).

2°) EEG CHANGES

- GROUP A

The compression with hydrogen-helium-oxygen mixture induced a decrease in alpha and beta activities in all lead. This decrease persisted during all the stay at 450 msw. The return to control value appeared during decompression after 300 msw (fig. 6).

During the compression, the increase of slow waves was recorded only in one subject (A3). This increase was around 200% for theta frequency activities between 400 and 450 msw on fronto-central and centro-temporal leads. This increase persisted around 100% during all the stay with H₂-He-O₂ mixture ; it disappeared during the stay in helium-oxygen mixture (fig. 7). This increase was not recorded significantly in temporo-occipital lead. The increase of the power of delta activities recorded during the compression was around 100% on anterior (Fp-C) and central (C-Tm) leads ; it disappeared after the shift to helium-oxygen mixture. A decrease of the power of delta activities was recorded in posterior lead (Tm-O).

A second subject (A1) presented an increase of theta activities (around 100%) only during the stay in hydrogen-helium-oxygen mixture (fig. 8). This increase was predominant on anterior lead (Fp-C). On this subject, the theta activities were also depressed in posterior lead (Tm-O).

The third subject (A2) did not present significant increase of theta activities (fig. 9). The power of delta activities was decreased in all the lead of subjects A1 and A2 during compression and stay at 450 msw.

The comparison of the data before and after the switch shown that the increase of theta activities was recorded only with the mixture composed with hydrogen (fig. 10). This increase was significant (Mann Whitney U-test - $P < 0.05$) ; it was also significant comparatively to the values obtained with helium-oxygen mixture ($P < 0.02$). The analysis of the power spectra before the shift of the mixture show a peak of theta activity which disappeared with the helium-oxygen mixture (fig. 11). Nevertheless, at the end of the stay and at the beginning of the

HYDRA 5

% Energy - ALPHA - Tm-O - E.C.

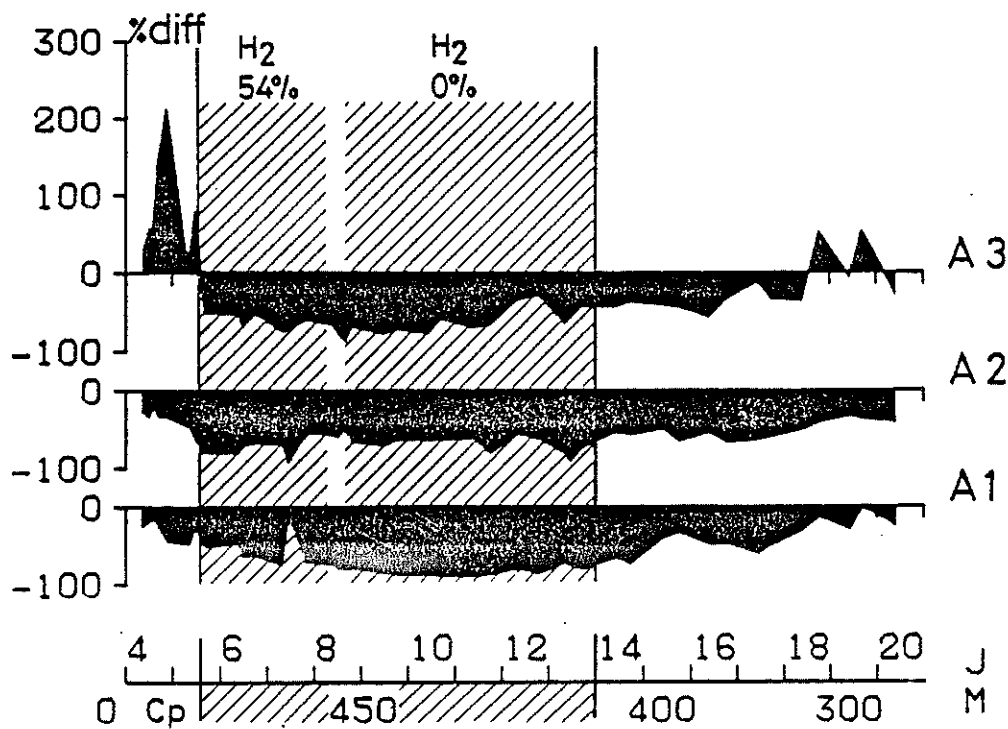

Figure 6 :

Evolution of power spectra of alpha frequency band as a function of depth on posterior lead (Tm-O), the eyes closed (E.C).

The increase of the power is expressed as percentage difference from control values.

The evolution of power is presented from bottom to top for subjects A1, A2, A3.

The shaded portion represents the stay at 450 msw ; the interruption of this shaded portion represents the change of the mixture.

HYDRA 5
%Energy - Fp - C - EC.

SU: A3

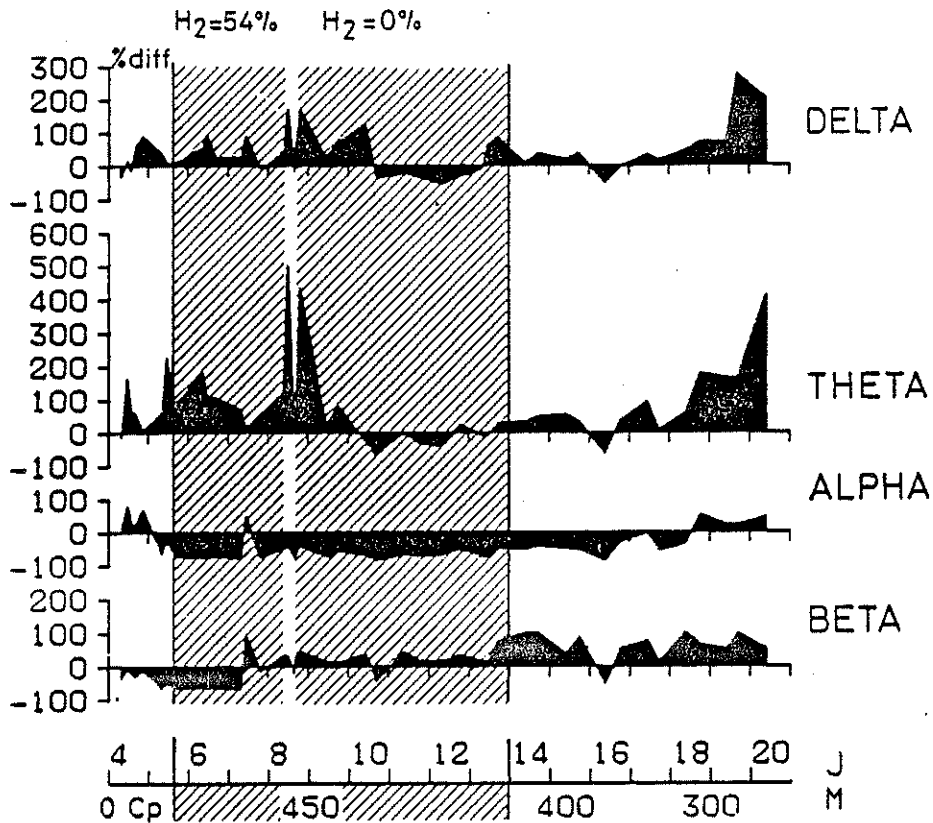

Figure 7 :

Evolution of EEG power spectra as a function of depth on anterior lead (Fp-C) of subject A3 during the dive.

The decrease of the power is expressed as percentage difference from control values.

The evolution of the power is represented for each frequency band from top to bottom : delta, theta, alpha and beta 1.

The shaded portion represents the stay at 450 msw. The interruption of this portion at J8 represents the period of the change of the mixture.

THIS DOCUMENT IS THE PROPERTY OF COMEX, all information contained herein may neither be reproduced, used, disclosed, transmitted nor in any way made public without the written permission of the owner, any person in possession of this document acknowledges being bound by the obligation to treat it as confidential.

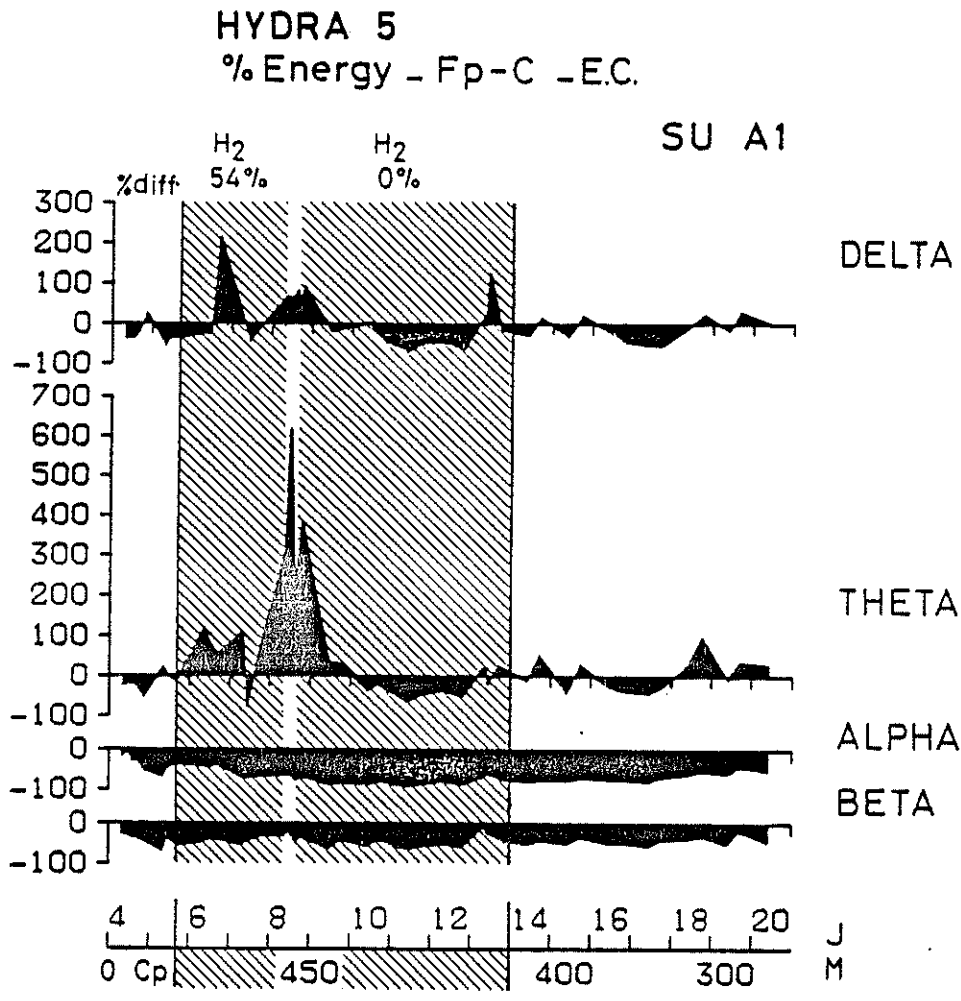

Figure 8 :

Evolution of the EEG power spectra as a function of depth on anterior lead (Fp-C) of the subject A1 during the dive.

(For the legend see figure 7).

« THIS DOCUMENT IS THE PROPERTY OF COMEX, all information contained herein may neither be reproduced, used, disclosed, transmitted nor in any way made public without the written permission of the owner, any person in possession of this document acknowledges being bound by the obligation to treat it as confidential. »

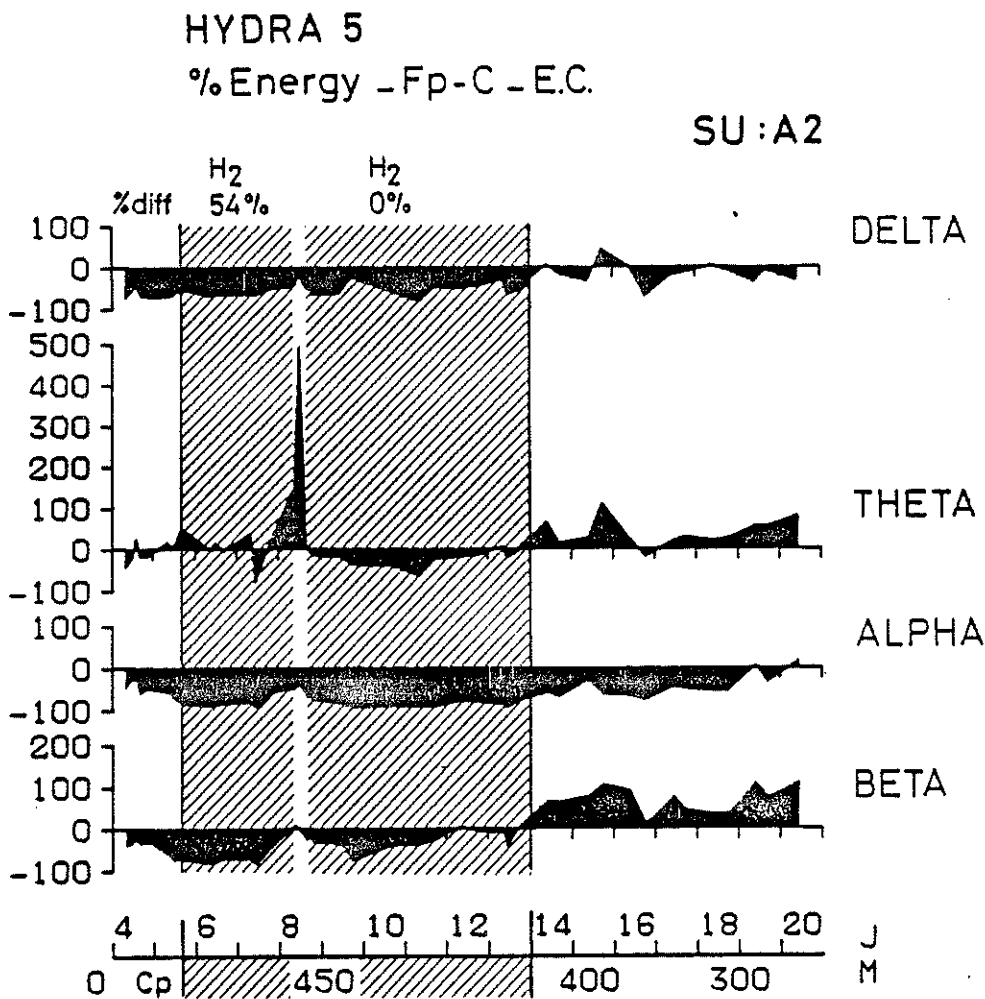

Figure 9 :

Evolution of the EEG power spectra as a function of depth on anterior lead (Fp-C) of the subject A2 during the dive.

(For the legend see figure 7).

HYDRA 5

% Energy - THETA - Fp-C - EC.
450 M

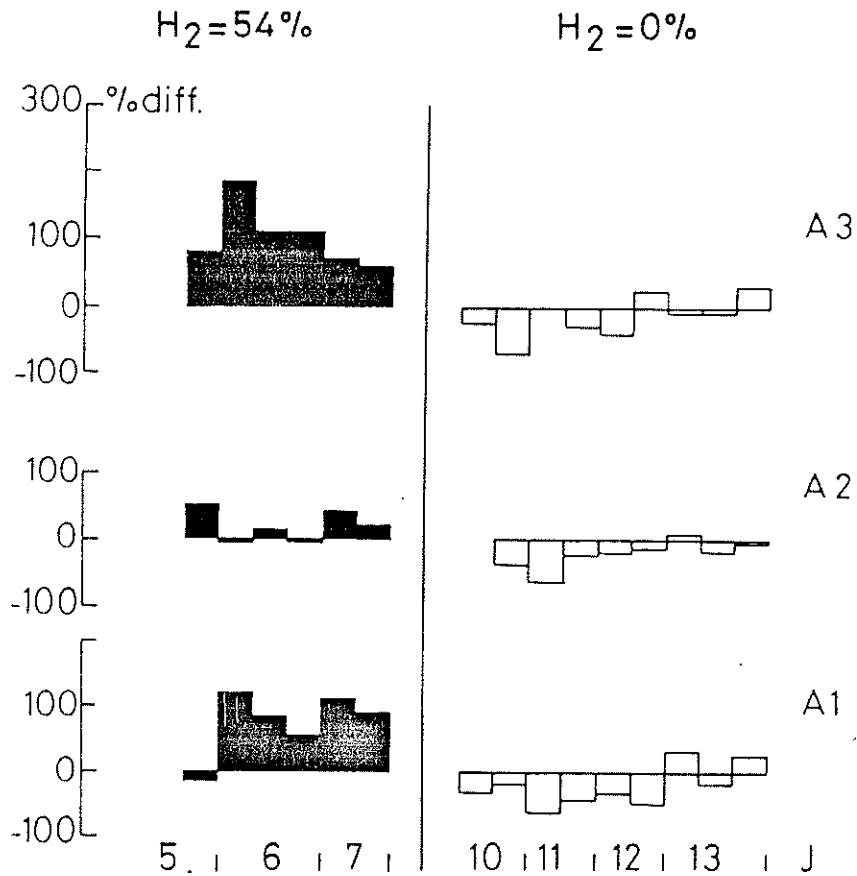

Figure 10 :

Increase of the power of theta activities on the anterior lead (Fp-C) during recording carried out in H₂-He-O₂ (H₂=54%) at 450 msw from J5 to J7 and during recording in He-O₂ at 450 msw from J10 to J13.

The increase is expressed as percentage difference from control value.

HYDRA 5
 POWER SPECTRA
 Fp-C - E.C.
 SU: A1

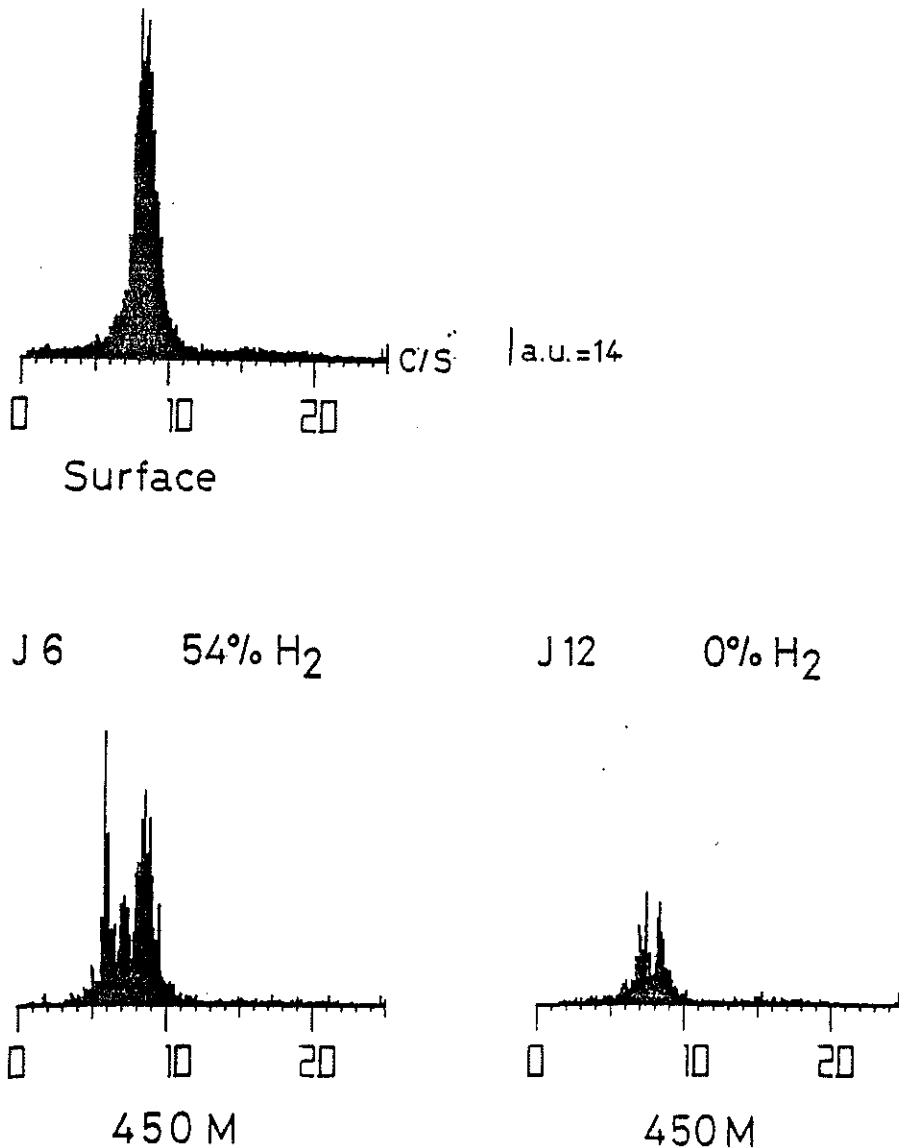

Figure 11 :

Power spectra of EEG activities recorded on anterior lead (Fp-C) of subject A1, the eyes closed.

At the top of the figure the power spectra at the surface.

At the bottom, on the left, the power spectra with H₂-He-O₂ (H₂=54%) the day J6.

At the bottom, on the right, the power spectra with 0% of hydrogen the day J12.

decompression, the power of theta activities increased again until 100% in subject A2 and even 200-300% in subject A3.

The change of mixture induced an increase of slow-waves especially theta in fronto-central and centro-temporal leads in all the subjects (fig. 12). This increase appeared in the first hour after the switch to 30% of hydrogen and the maximum value (500% to 600% increase) was recorded for the test performed three hours later (fig. 13).

The second shift to 0% of hydrogen induced a new increase of theta activities in two subjects which disappeared during the following 24 hours. The subjects A2 seemed to have a depression of his EEG activities in every frequency bands analyzed.

The increase of theta was characterized by the appearance of bursts of slow waves of high amplitude (fig. 14).

- GROUP B

With the team B who stayed all the time at 450 msw with hydrogen-helium-oxygen mixture, similar EEG changes were recorded.

During the compression, the power of alpha activities decreased in all the subjects (fig. 15) ; this decrease persisted during all the stay at 450 msw ; it disappeared during decompression around 300 msw before the disappearance of hydrogen in the mixture. The power of beta activities was slightly depressed at 450 msw in all the subjects.

The increase of the power of theta activities was more consistent with this group ; it appeared on anterior (Fp-C) and central (C-Tm) leads ; it was not recorded on posterior lead (Tm-O). It appeared during the compression in two subjects (B2 and B3) (fig. 16, 17) and during the stay in B1 (fig. 18). The increase of theta activities which was of 100 to 500% according to the subject, persisted during all the duration of the stay and disappeared during the decompression at different times according to the subject : rapidly in subject B1 (around 430 msw) ; around 300 msw in subject B3 ; it was always present in subject B2 when we stopped recording at 160 msw.

An increase of the power of delta activities around 200-300% was recorded on anterior lead (Fp-C) of subjects B1 et B2 ; it followed the same evolution than theta activities.

« THIS DOCUMENT IS THE PROPERTY OF COMEX, all information contained herein may neither be reproduced, used, disclosed, transmitted nor in any way made public without the written permission of the owner. any person in possession of this document acknowledges being bound by the obligation to treat it as confidential. »

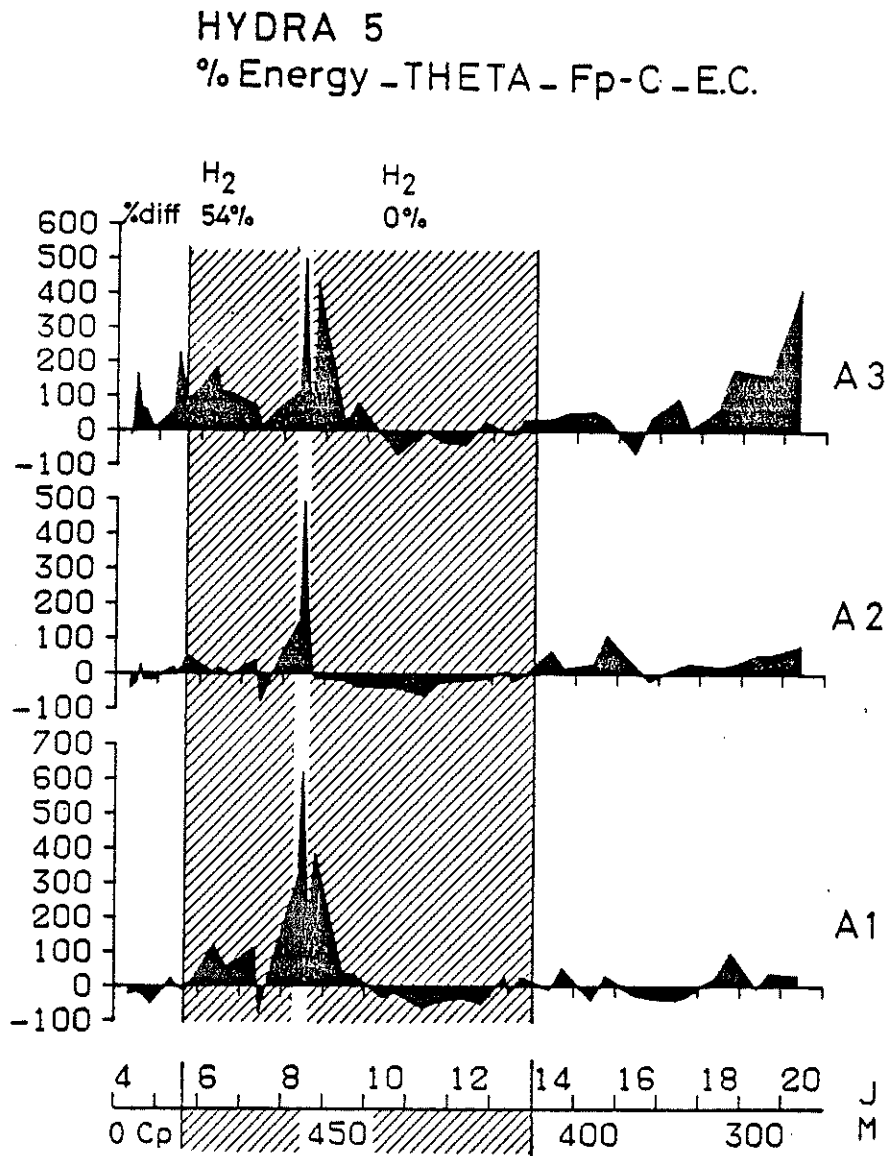

Figure 12 :

Evolution of EEG power spectra of theta frequency band as a function of depth on anterior lead (Fp-C) of the three subjects of the team A.

(For the legend see figure 6).

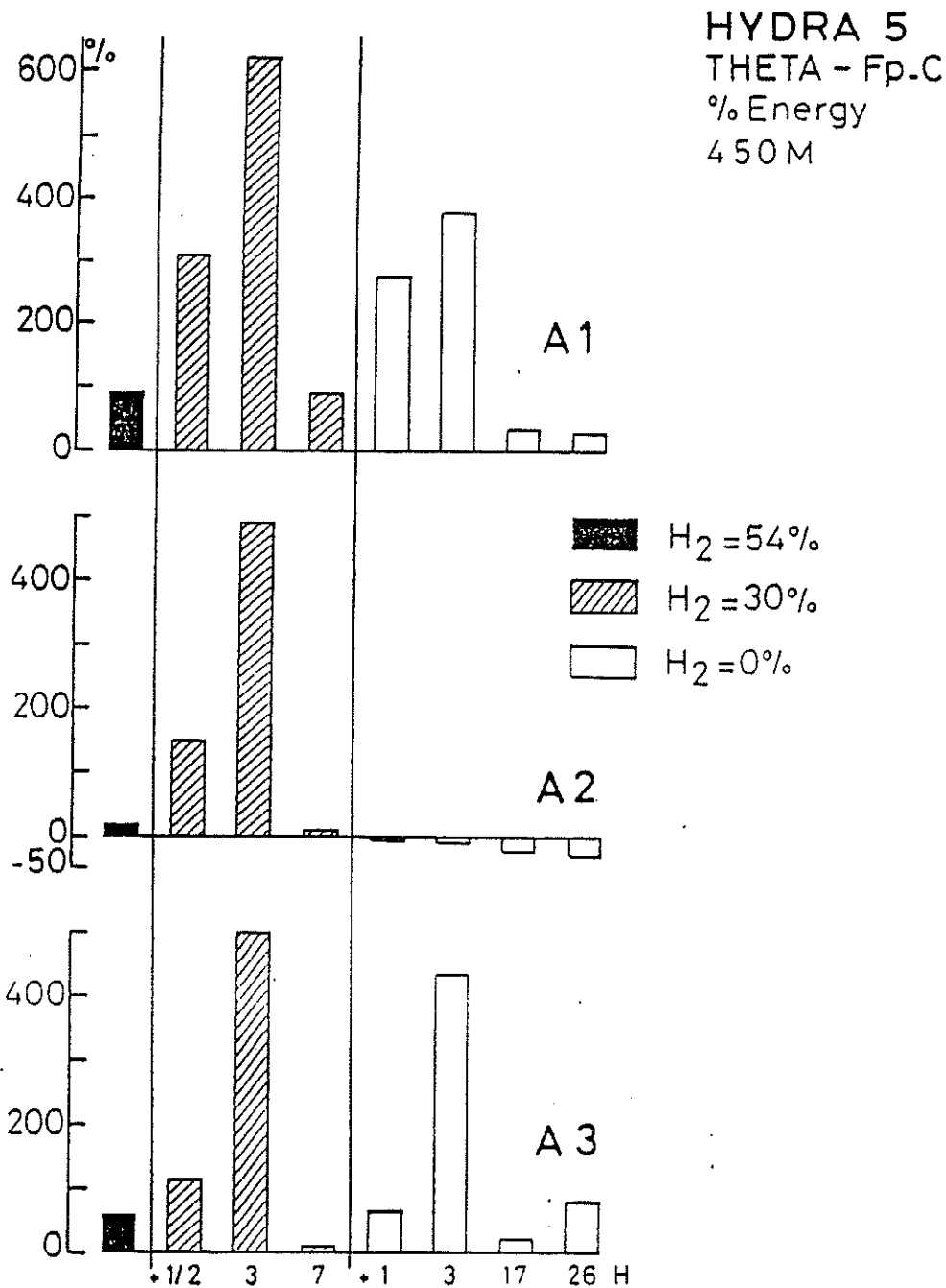

Figure 13 :

Evolution of the power of theta activities of the three subjects of team A during the change of mixture.

The increase is expressed as percentage difference from control value.

On the left of the figure, the increase in theta activities with 54% of H_2 . On the middle, the increase of theta activities, 30 min, 3 hours and 7 hours after the shift to 30% of H_2 . On the right, the increase of theta activities, 1 hour, 3 hours, 17 hours and 21 hours after the shift to 0% of H_2 .

« THIS DOCUMENT IS THE PROPERTY OF COMEX, all information contained herein may neither be reproduced, used, disclosed, transmitted nor in any way made public without the written permission of the owner, any person in possession of this document acknowledges being bound by the obligation to treat it as confidential. »

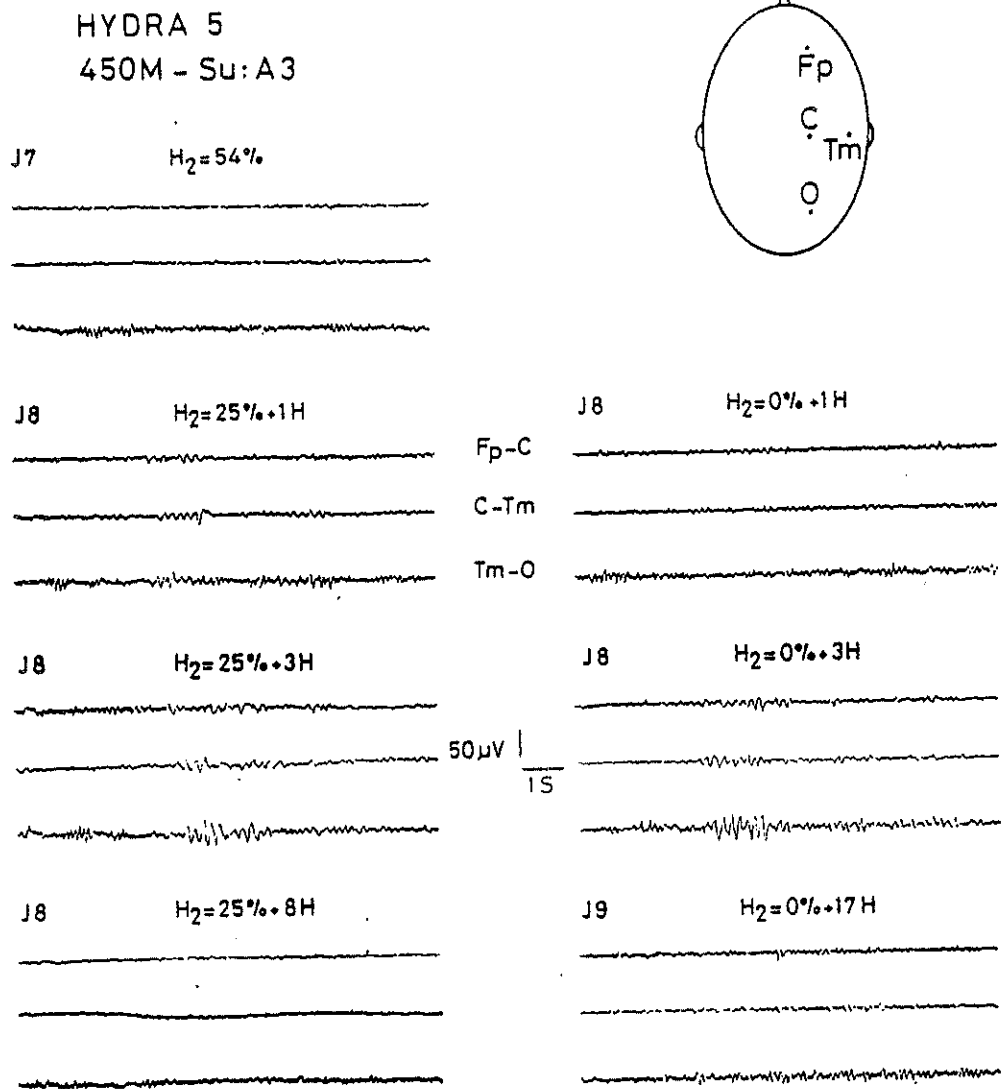

Figure 14 :

Subject A3 : EEG with eyes closed at different times during the change of mixture.

HYDRA 5

%Energy - ALPHA - Tm-O - E.C.

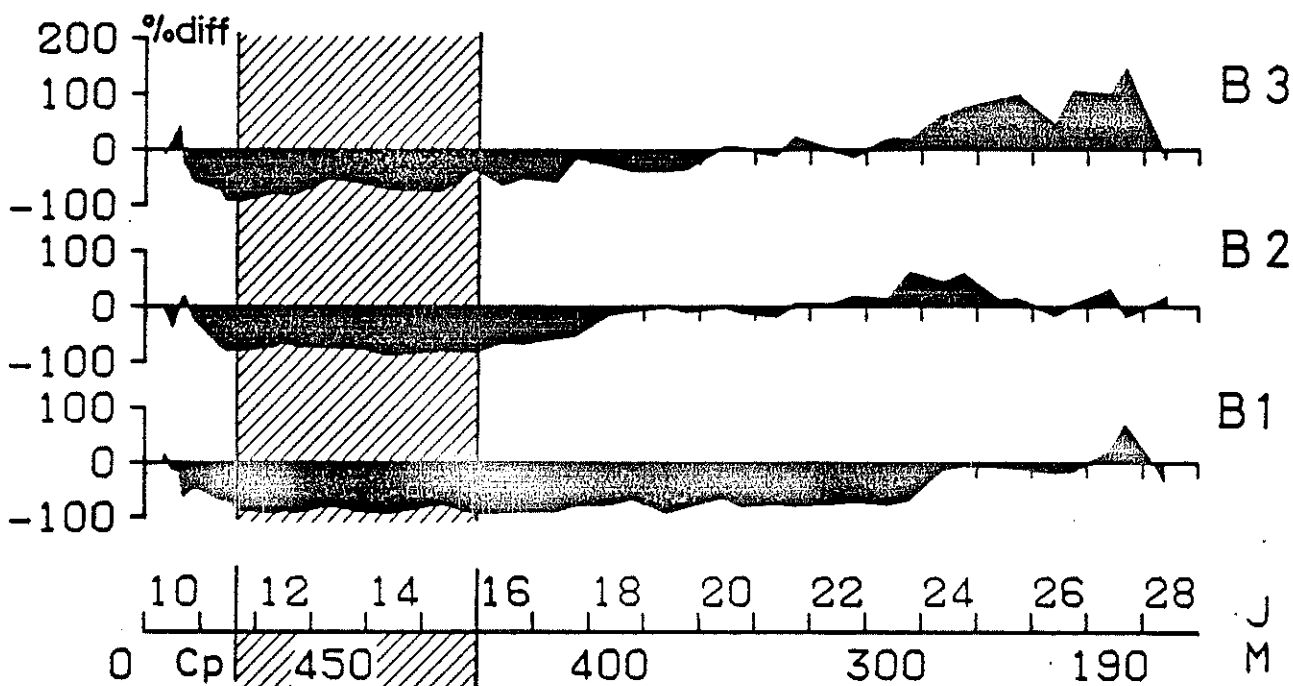

Figure 15 :

Evolution of the power of alpha activities on posterior lead (Tm-O) of the three subjects of group B.

(For legend see figure 6).

« THIS DOCUMENT IS THE PROPERTY OF COMEX. all information contained herein may neither be reproduced, used, disclosed, transmitted nor in any way made public without the written permission of the owner. any person in possession of this document acknowledges being bound by the obligation to treat it as confidential. »

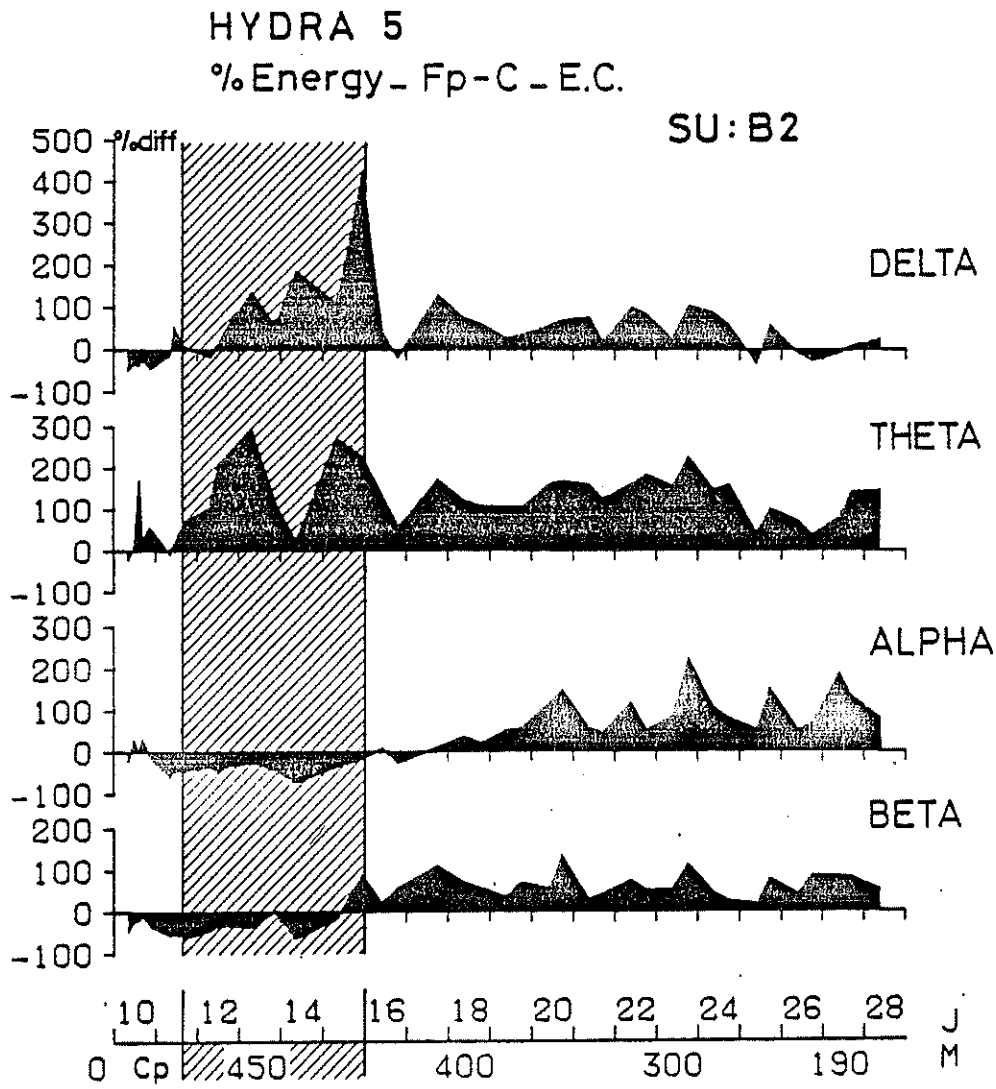

Figure 16 :

Evolution of the EEG power spectra as a function of depth on anterior lead (Fp-C) of the subject B2 during the dive.

(For legend see figure 7).

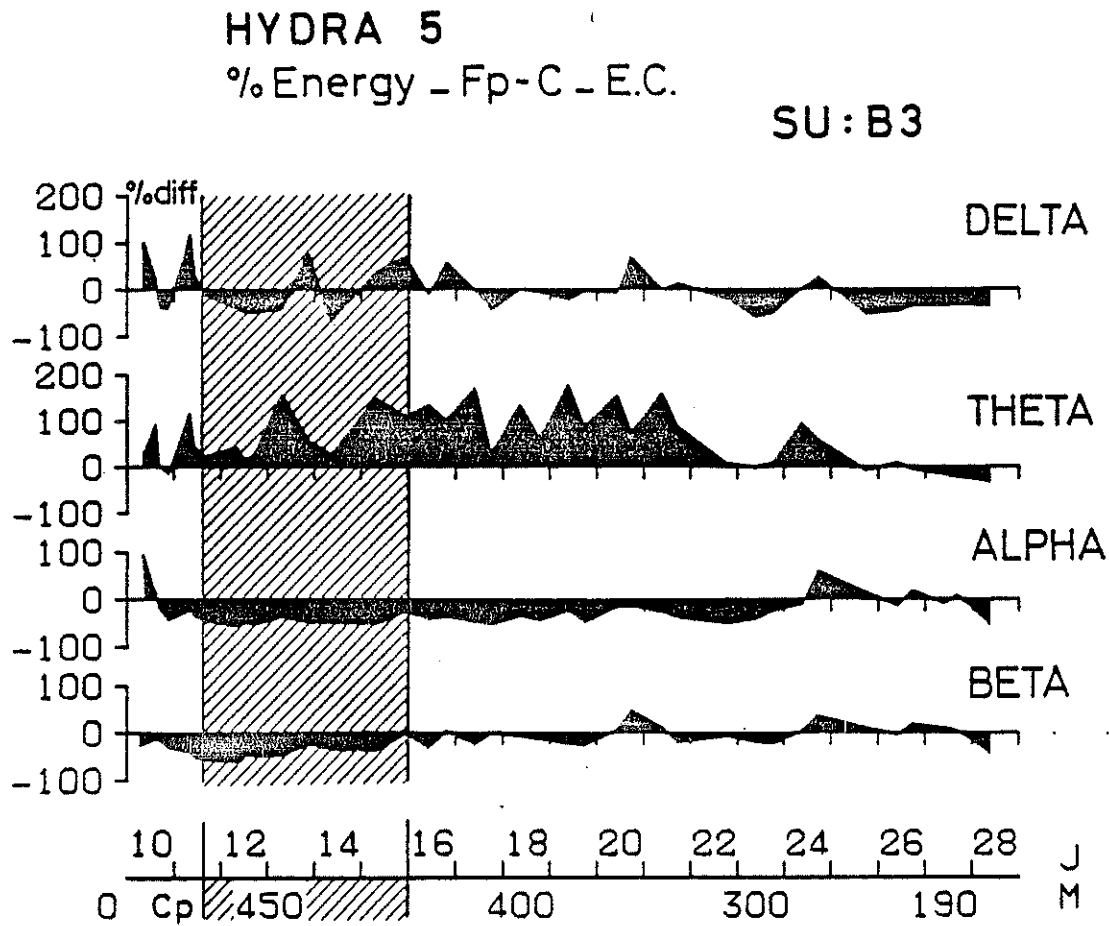
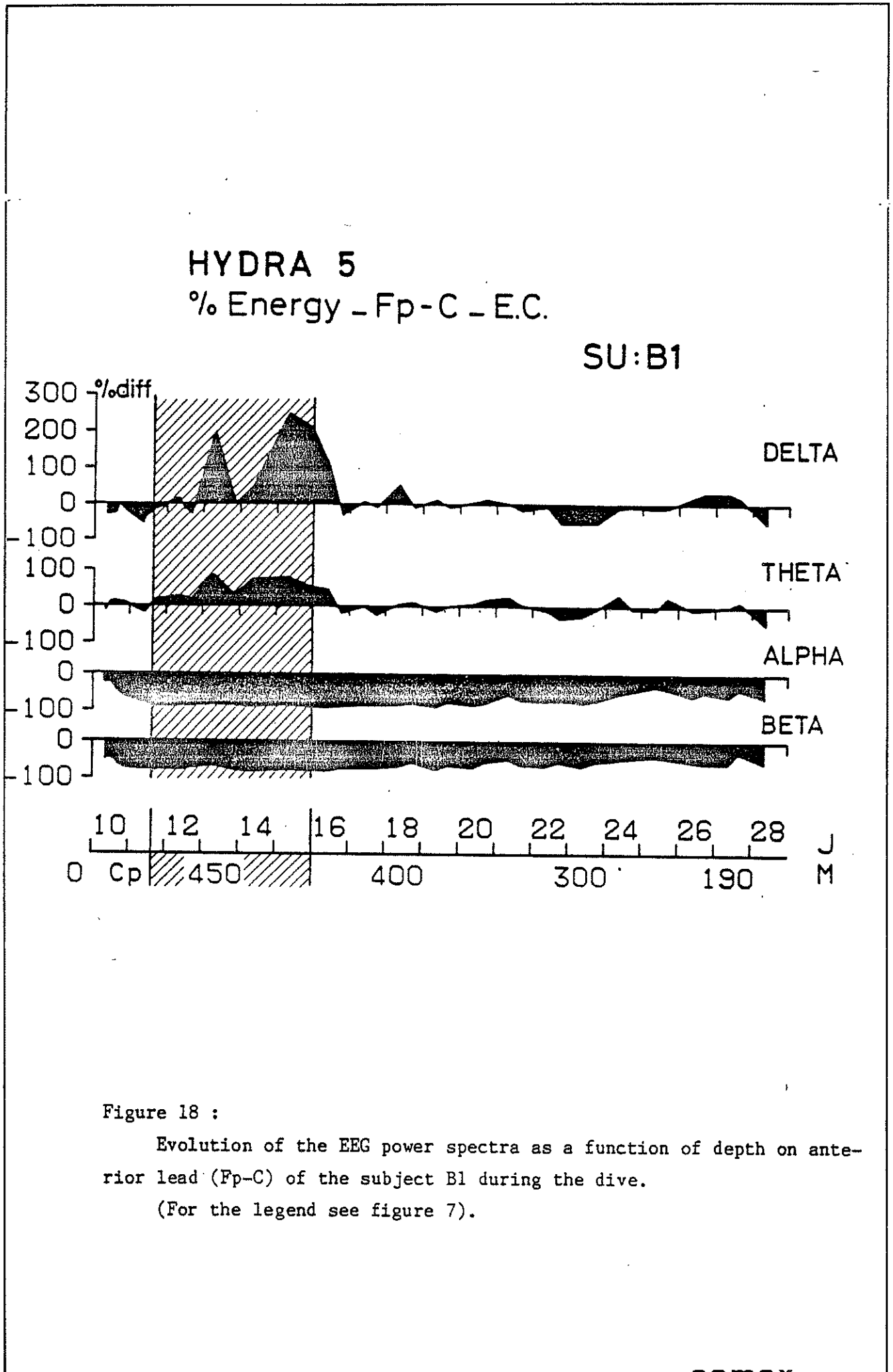

Figure 17 :

Evolution of the power spectra as a function of depth on anterior lead (Fp-C) of the subject B3 during the dive.

(For the legend see figure 7).



3°) SLEEP DISTURBANCES

The analysis of sleep of group B shown disturbances which appeared the second night of the compression and persisted during the stay at 450 msw. The disturbances disappeared more or less rapidly during the decompression.

a) Sleep duration

The sleep duration was decreased from the first night of compression in B3 (5H 00 against a mean duration of 7H 00 during the prediva) (table 1) ; it was decreased from the second night in the subjects B1 and B2. This decrease persisted during the stay at 450 msw ; it was slight in B1 (30 minutes) but important in B2 and B3 (more than 2 hours). The comparison of the mean duration for the 3 subjects for the 3 nights of the prediva and 3 nights at 450 msw gave a significant decrease of $451,81 \text{ min} \pm 39 \text{ min}$ to $344 \text{ min} \pm 70 \text{ min}$ (Wilcoxon test : $W=1 - P < 0.01 - n=9$). During the compression, the sleep duration returned to values which were near the prediva values.

b) Sleep cycles

The number of cycles during the sleep which was of five per night during prediva, decreased from the first night of compression to the last night at 450 msw in subject B3. With B1 and B2, this decrease was recorded the second night of compression and the two first nights of the stay (fig. 19). The number of cycle increased during decompression (6 to 8 cycles).

c) Stages of sleep

The duration and the percentage of duration were disturbed.

The awake periods were increased. The occurrence was increased only in B3 and the changes for the group were not significant. The duration and the percentage duration were increased at 450 msw compared to the results of prediva (fig. 20, 21, 22) : prediva mean duration 16

	B.1	B.2	B.3
Confinement	7H33 ± OH19	7H56 ± OH11	7H00 ± OH26
J.5	6H46	8H00	7H15
J.7	8H29	8H06	7H10
J.8	7H49	7H45	6H28
Compression			
J.9	6H26	8H06	4H59
J.10	6H04	6H21	5H23
Séjour 450 m	7H00 ± OH34	5H32 ± 1H38	4H47 ± OH29
J.11	6H56	4H20	4H46
J.12	7H29		4H52
J.13	7H26	6H37	4H11
J.14	6H16	5H39	5H21
Décompression			
J.15	7H11	6H03	6H17
J.16 430m	8H12	7H50	6H38
J.17 410m	7H42	6H44	7H21
J.18 390m	7H54	6H16	7H11
J.19 350m	7H19	6H33	6H19
J.20 325m	8H37	7H08	7H28
J.21 300m	7H52	6H22	6H26
J.22 280m	8H26	7H37	7H07
J.23 256m	7H45	7H19	8H04
J.24 230m	7H28	7H51	5H51
J.25 200m	6H09	6H37	6H21
J.26 180m	6H52		6H02

Table 1

Duration of sleeps of the three subjects during the nights of the dive. The mean duration is given for the nights of the pre-dive and the nights at 450 msw.

HYDRA 5-SOMMEIL-B1

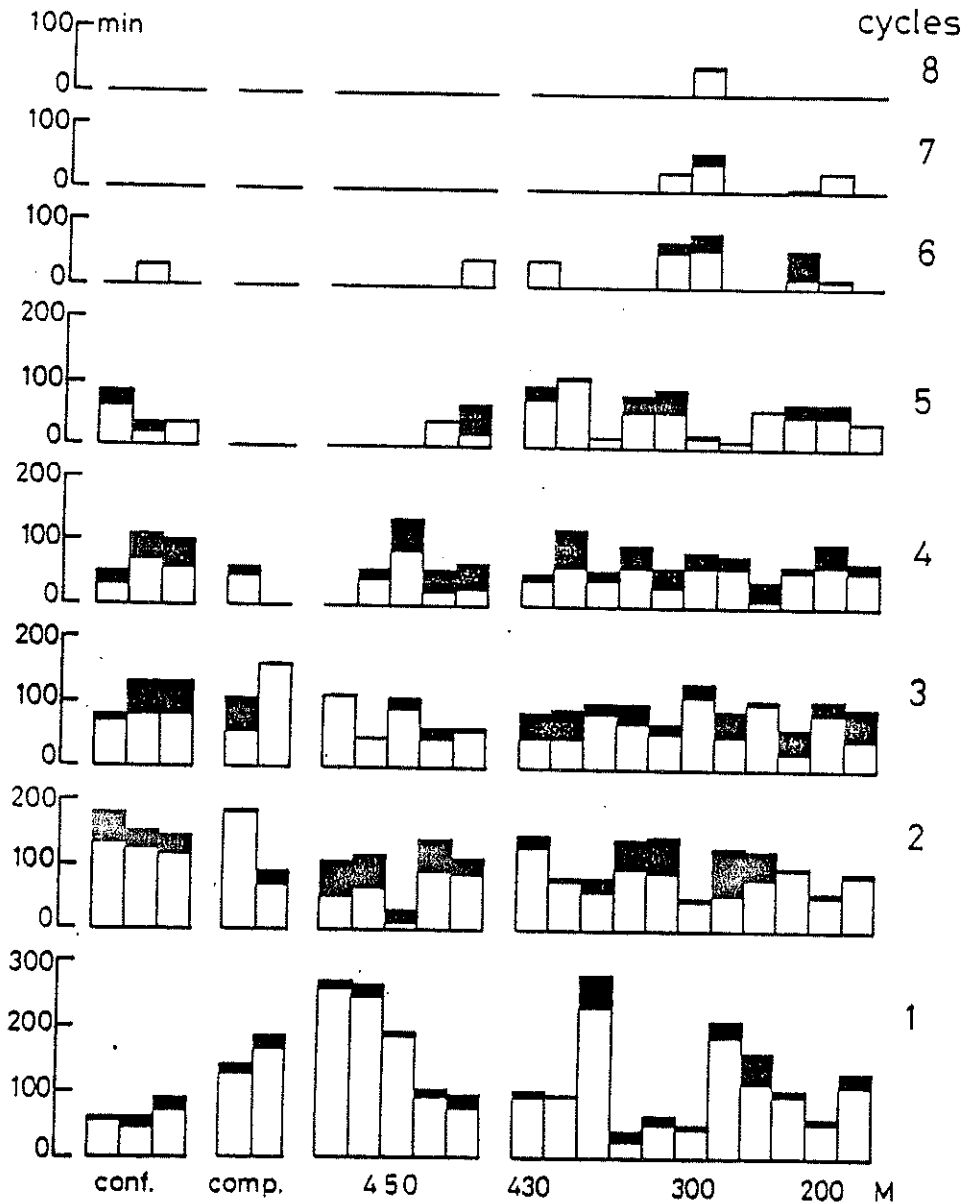

Figure 19 :

Evolution of the sleep cycles of the subject B1, night by night, during the dive. The histograms represented the duration of one cycle : slow waves sleep (white zone) ended by paradoxical sleep (black zone). The sleep cycles during the night are represented from bottom to top. From left to the right, we have the nights during the pre-dive (conf), the compression (comp), the stay at 450 msw (450) and the decompression from 450 to 180 msw.

« THIS DOCUMENT IS THE PROPERTY OF COMEX, all information contained herein may neither be reproduced, used, disclosed, transmitted nor in any way made public without the written permission of the owner. any person in possession of this document acknowledges being bound by the obligation to treat it as confidential ».

HYDRA 5 - SOMMEIL - B1

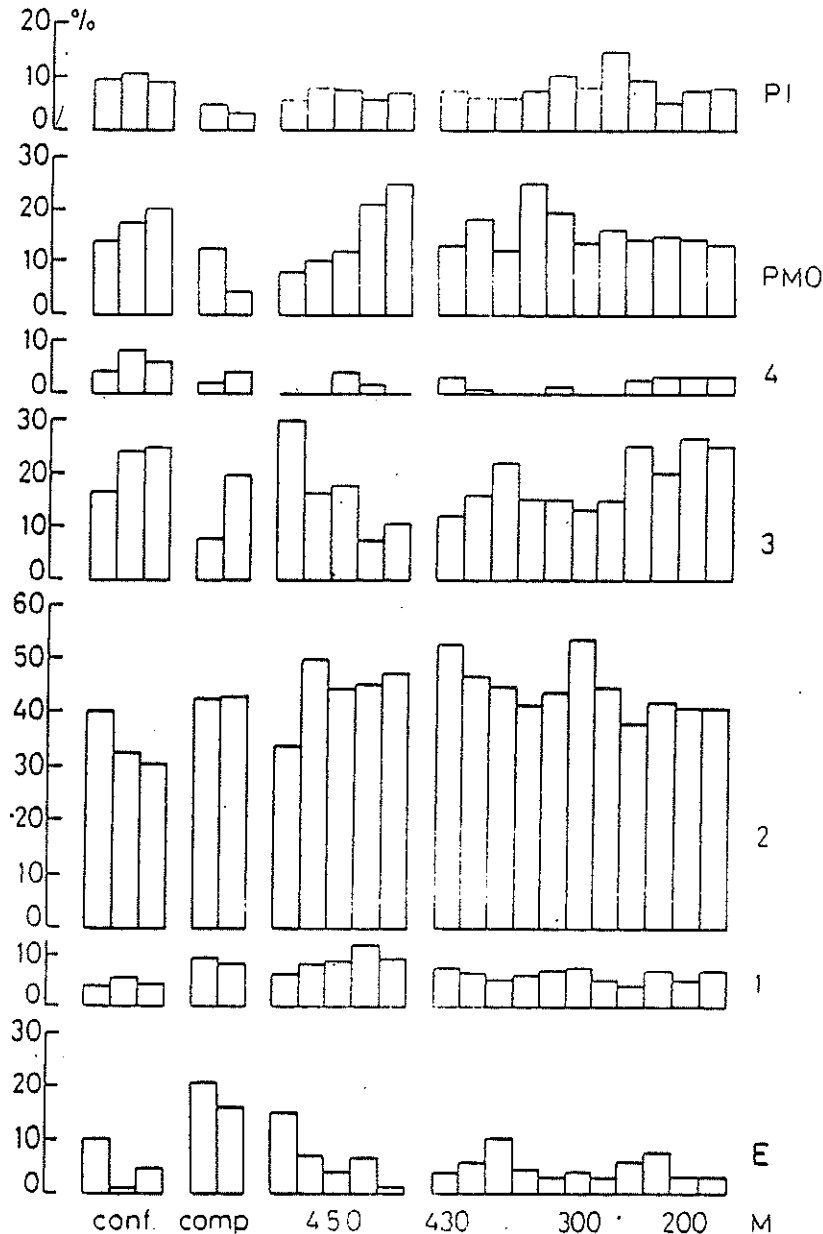

Figure 20 :

Evolution of percentage duration of the stages of sleep of subject B1 during the dive.

The stages of sleep are represented from bottom to top, from awake periods to intermediary stages. From left to right, we have the nights of the predive (conf), the compression (comp), the stay at 450 msw (450) and the decompression from 450 to 180 msw.

HYDRA 5 - SOMMEIL - B2

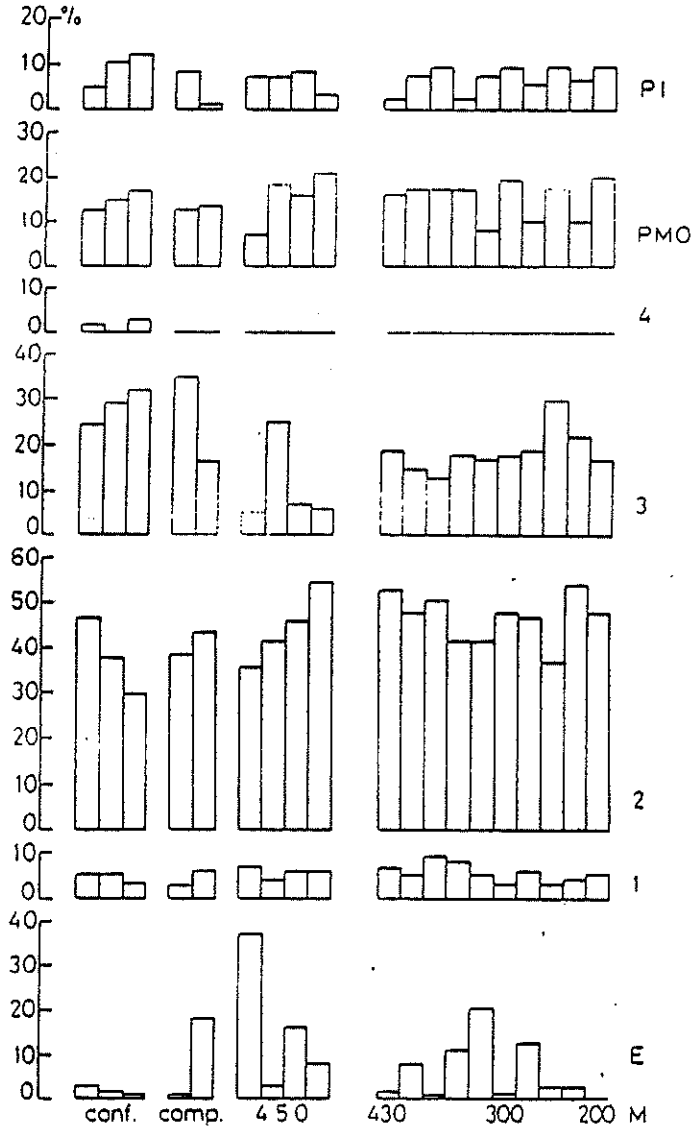

Figure 21 :

Evolution of the percentage duration of the stages of sleep of subject B2.

(For the legend see figure 20).

« THIS DOCUMENT IS THE PROPERTY OF COMEX, all information contained herein may neither be reproduced, used, disclosed, transmitted nor in any way made public without the written permission of the owner, any person in possession of this document acknowledges being bound by the obligation to treat it as confidential. »

HYDRA 5 - SOMMEIL - B3

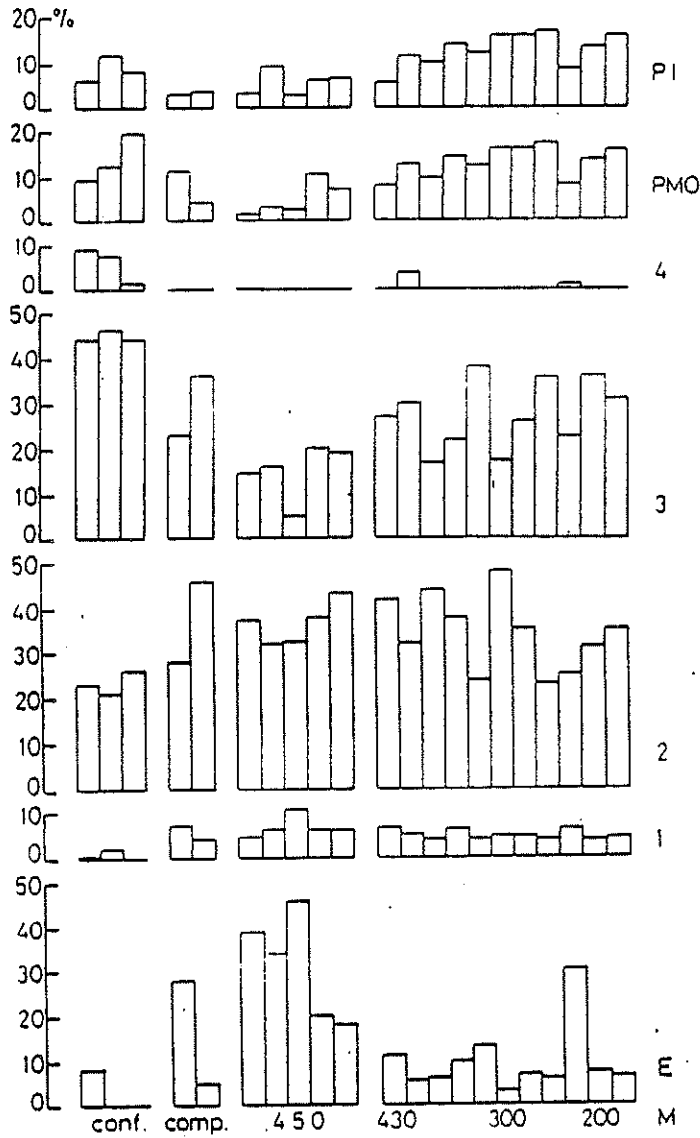

Figure 22 :

Evolution of the percentage duration of the stages of sleep of subject B3.

(For the legend see figure 20).

« THIS DOCUMENT IS THE PROPERTY OF COMEX, all information contained herein may neither be reproduced, used, disclosed, transmitted nor in any way made public without the written permission of the owner, any person in possession of this document acknowledges being bound by the obligation to treat it as confidential. »

min - 3.49% of the sleep duration ; 450 msw mean duration 92 min - 21% of the sleep duration ($W=0 - P < 0.01$). The duration of awake period decrease during decompression.

The stage 1 of sleep increased during the compression and during the stay at 450 msw. The occurrence increase from 16 during pre dive to 28 at 450 msw (Wilcoxon test : $W=5 - P < 0.05$). The duration and the percentage of duration increased from 16,7 min - 3,45% during pre dive, to 31,56 min - 7,22% at 450 msw ($W=4$ and $W=2 - P < 0.05$). During the decompression the stage 1 returned progressively to pre dive values.

The stage 2 of sleep presented different modifications. The occurrence increased slightly in B1 et B3 ; it decreased in B2. The comparison of the mean occurrence obtained from pre dive and from the nights at 450 msw was not significant. The duration of this stage increased in two subjects (B1 and B3) ; it was decreased in B2. The comparison of the mean obtained during pre dive (152 min) and that obtained from the nights at 450 msw was not significant. The percentage duration of the stage 2 was increased ; this increase was in relation with the decrease of the duration of the sleep in all the subject (fig. 20, 21, 22) : it was of 32% for the pre dive and of 40% at 450 msw ($W=5 - P < 0.05$). The percentage returned to pre dive value during decompression around 300 msw.

The stage 3 decreased. The occurrence decreased during the compression and the stay at 450 msw ($W=4 - P < 0.05$). The duration was of 147 minutes during pre dive and was of 65 minutes during the stay at 450 metres ($W=3 - P < 0.05$). The percentage duration was decreased by half : 31,86% for pre dive ; 14,77% at 450 metres ($W=3 - P < 0.05$). The stage 3 was increased at the beginning of the decompression and returned to control value around 300 msw (fig. 20, 21, 22).

The stage 4 decreased and even disappeared in some subject. The occurrence become around zero ($W=0 - P < 0.01$). It disappeared in B2 and B3 during the compression and the stay at 450 msw ; it disappeared the first and the second night in B1. The duration and the percentage duration also decreased ($W=0 - P < 0.01$). The stage 4 did not reappear systematically during decompression (fig. 20, 21, 22).

The paradoxical sleep decreased. The occurrence decreased during the compression and during the first nights at 450 msw. The duration

was of 71 minutes for predive and of 46 minutes at 450 msw ($W=1 - P < 0.01$). The percentage duration decreased from 15% during predive to 10% at 450 msw ($W=5 - P < 0.05$). The paradoxical sleep returned to predive value at the end of the stay or at the beginning of the decompression (fig. 20, 21, 22).

The intermediary stages followed the evolution of the paradoxical sleep. The occurrence, the duration and the percentage duration decreased ($W=2 - P < 0.01$). They returned progressively to control values during decompression.

IV - COMMENTS

1°) CLINICAL SYMPTOMS

The neurophysiological studies performed during HYDRA V have shown that hydrogen-helium-oxygen mixture with a percentage of 54% of H_2 did not induce tremor or other clinical symptoms of HPNS (dysmetria, fasciculation, drowsiness). The transient tremor recorded on subject B3 seems to be in relation with a stress due to the thermal incomfort. This is confirmed by the fact that the tremor disappeared when the thermal comfort is found by this subject.

The comparison of these results with those obtained with the same curve of compression but with other mixtures shows that the values of tremor obtained in this dive are the lightest and that they are at the lower part of the scale of the values obtained with $He-N_2-O_2$ mixture. The tremor recorded with the same curve of compression in $He-O_2$ mixture is at the higher part of this scale (Rostain et al. 1984c, d).

The suppression of tremor and of other clinical symptoms of HPNS indicates that the hydrogen-helium-oxygen mixture with 54% of H_2 is efficient to prevent the appearance of these symptoms.

The tremor appears rapidly after the change of the mixture. This phenomenon might be the consequence of the disappearance of hydrogen which was necessary to suppress the tremor ; it might be also the consequence of the fast increase of helium and in this case it would be equivalent to a rapid compression. The persistence of the tremor

after the shift suggests that the two phenomenons are present.

2°) EEG CHANGES

The EEG changes are characterized by a decrease in alpha frequency activities and by an increase of slow waves especially theta. The decrease in alpha frequency activities was also observed during HYDRA IV experiment (Carlioz et al. 1984). Nevertheless, during HYDRA V, with the team A this increase was equivalent with H₂-He-O₂ and He-O₂ mixtures.

The increase in slow waves appeared during the compression or the stay with H₂-He-O₂ (100 à 500%) is similar to those recorded with the same compression curve in DRET 79/131, ENTEX V and VIII experiments where the mixture was helium-nitrogen-oxygen (N₂:5%) (Rostain et al. 1983, 1984c), or during ENTEX IX at 450 msw with helium-oxygen mixture (Rostain et al. 1984c).

With the team B, this increase in theta activities persisted during all the stay and disappeared during decompression at depths analogous to those noted for other decompression.

With the team A, the increase in theta activities was accentuated during the change of the mixture. This increase appeared rapidly and was intense in the three subjects. The decrease which was recorded during the test performed 7 hours after the shift, suggests that this manifestation is in relation with the rapid change of the mixture and the sudden increase of helium partial pressure ; it might be equivalent to a fast compression effect.

After the change of the mixture, during the stay at 450 msw in helium-oxygen, the power of theta activities was equal or less than the power of the control values. This change which was never observed before could be related with a secondary effect of the sudden change of the mixture... This hypothesis would be confirmed by the progressive increase of theta activities which was recorded at the end of the stay and at the beginning of the decompression ; but the mecanism can not be explained yet.

The results of EEG studies indicates that the H₂-He-O₂ mixture with 54% of hydrogen induce similar changes to those recorded with He-

N₂-O₂ ou He-O₂ at 450 msw with the same compression curve.

3°) SLEEP DISTURBANCES

The study of sleep of the three subjects of team B at 450 msw has shown :

- a decrease of sleep duration
- an increase of awake periods
- an increase of stage 1
- an increase of percentage duration of stage 2
- a decrease of stage 3
- a disappearance of stage 4
- a decrease of paradoxical sleep and intermediary stages.

These changes are recorded during compression from 300 msw and during the first nights at 450 msw. An improvement is recorded for some stages at the end of the stay, but the sleep disturbances disappeared essentially during the decompression.

The sleep disturbances are similar to those recorded with other mixtures. During a dive, generally the sleep duration decreased (Rapport DRET 79/131 ; Rapport ENTEX V). The increase of awake periods and stage 1 are observed in every dives (Rostain et al. 1973, 1981 ; Rostain et Regesta 1976 ; Rapports DRET 79/131, 80/642, 83/1130).

The duration of stage 2 is not increase, contrary to the observations carried out in other dives ; but the percentage duration is increased since the duration of the total sleep is decreased.

The decrease of stage 3 and 4 and even the disappearance of the last one is classically seen in diving from 300 msw (Rostain et al. 1973, 1981 ; Rostain et Regesta 1976 ; Wilcox et al. 1976 ; Townsend et Hall 1978).

The decrease of paradoxical sleep and of intermediary stages is not recorded systematically during other experiments. This decrease has been observed at 450 msw in ENTEX V experiment with He-N₂-O₂ mixture (Rapport DRET 80/642). A such decrease is observed generally at greater depths (610 msw for example : ENTEX IX : Rapport DRET 83/1130).

As we said before, the sleep disturbances have a similar evolution that the other symptoms of HPNS and these disturbances must be considered as other symptoms of HPNS (Rostain et Regesta 1976 ; Rostain et al. 1981). Parameters, such as temperature or incomfort of the pressure chamber, do not play a primary role in the appearance of this troubles or in their intensity, but they may add to hyperbaric effects notably in the case of thermal incomfort (subject B3 at the end of compression).

Consequently, the sleep disturbances in hydrogen-helium-oxygen mixture are similar to the sleep disturbances recorded with helium-oxygen or helium-nitrogen-oxygen mixture during dives performed in the same environmental conditions. At this time, with the number of subjects studied in H₂-He-O₂, it is not possible to evaluate the intensity of the sleep disturbances comparatively to the results obtained with other mixtures.

V - CONCLUSION

The neurophysiological studies performed during HYDRA V have shown :

- that hydrogen-helium-oxygen mixture with 54% of H₂ prevents the appearance of clinical symptoms of HPNS ;
- that this mixture does not prevent the appearance of EEG changes ;
- that this mixture does not prevent the sleep disturbances ;
- that the shift of mixture induces the appearance of "HPNS symptoms".

The hydrogen-helium-oxygen mixture with 54% of H₂ reduces or prevents the clinical symptoms of HPNS ; this effect is probably in relation with the "narcotic potency" of hydrogen which antagonizes the pressure according to the observations or hypothesis of several authors (Johnson et al. 1942 ; Lever et al. 1971 ; Miller et al. 1973 ; Miller 1975). The suppression of the clinical symptoms and the improvement of the comfort of the divers produce by this mixture open new perspectives for future deep diving.

REFERENCES

1. BRAUER, R.W. and WAY, R.O. Relative narcotic potencies of hydrogen, helium, nitrogen and their mixtures. *J. Appl. Physiol.* 1970, 29 : 23-31.
2. BRAUER, R.W., DIMOV, S., FRUCTUS, X., GOSSET, A. et NAQUET, R. Syndrome neurologique et électrographique des hautes pressions. *Rev. Neurol.* 1969, 121 : 264-265.
3. CARLIOZ, M., GARDETTE-CHAUFFOUR, M.C., ROSTAIN, J.C. and GARDETTE, B. Hydrogen narcosis : psychometric and neurophysiological study. In : G. Susbielle, M. Comet, M. Jacquin et R. Sciarli eds. *Proceeding of Xth Congress of European Undersea Bio-Medical society.* EUBS, Marseille, 1984, p 97-109.
4. FRUCTUS, X., NAQUET, R., GOSSET, A., FRUCTUS, P. et BRAUER, R.W. Le Syndrome Nerveux des Hautes Pressions. *Marseille Med.* 1969, 6 : 509-512.
5. JOHNSON, F.H., BROWN, D.E.S. and MARSLAND, D.A. Pressure reversal of the action of certain narcotics. *J. Cell. Physiol.* 1942, 20 : 269-276.
6. LEVER, M.J., MILLER, K.W., PATON, W.D.M. and SMITH, E.B. Pressure reversal of anaesthesia *Nature.* 1971, 231 : 368-371.
7. MILLER, K.W. Review of the effects of pressure and anaesthetics on membranes. In : *The strategy for Future Diving to Depths Greater than 1000 feet.* UMS report number WS 6-15-75. 1975, p 19-21.
8. MILLER, K.W., PATON, W.D., SMITH, R.A. and SMITH, E.B. The pressure reversal of general anesthesia and the critical volume hypothesis. *Molecular Pharmacol.* 1973, 9 : 131-143.

9. ROSTAIN, J.C. et NAQUET, R. Résultats préliminaires d'une étude comparative de l'effet des mélanges oxygène-hélium et oxygène-hydrogène et des hautes pressions sur le babouin *Papio papio*. In : X. Fructus ed. Proc. des troisièmes journées internationales d'hyperbarie et de physiologie subaquatique. Marseille 1970. Doin Paris. 1972, p. 44-49.
10. ROSTAIN, J.C., REGESTA, G. and NAQUET, R. Study of the organisation of sleep of divers staying at 300 meter depths in an oxy-helium atmosphere. *Electroencep. clin. Neurophysiol.* 1973, 34 : 788.
11. ROSTAIN, J.C. et REGESTA, G. Evoluzione del sonno di subacquei durante un soggiorno prolungato ad una pressione di 31 ATA di miscela elio-ossigeno. *Giornale di Igiene e Medicina Preventiva.* 1976, 17 : 1-7.
12. ROSTAIN, J.C., IMBERT, J.P., GARDETTE, B., LEMAIRE, C., DUMAS, J.C. and NAQUET, R. Compression methods : II study of the effects of profiles and N2 injections on HPNS of the baboon *Papio papio*. *Undersea Biomed. Res.*, 1978, 5 : 46.
13. ROSTAIN, J.C., GARDETTE-CHAUFFOUR, M.C. and NAQUET, R. Sleep in man during He-O2 dives at 500 and 610 m. *Undersea Biomed. Res.* 1981, 8 (suppl.) : 17-18.
14. ROSTAIN, J.C., LEMAIRE, C., GARDETTE-CHAUFFOUR, M.C., DOUCET, J. and NAQUET, R. Estimation of human susceptibility to the high pressure nervous syndrome. *J. Appl. Physiol. : Respirat. Environ. Exercise. Physiol.* 1983, 54 : 1063-1070.
15. ROSTAIN, J.C., DUMAS, J.C., GARDETTE, B., IMBERT, J.P. and LEMAIRE, C. Effects of addition of nitrogen during rapid compression of baboon. *J. Appl. Physiol. : Respirat. Environ. Exercise Physiol.* 1984 a, 57 : 332-340.

16. ROSTAIN, J.C., GARDETTE, B., GARDETTE-CHAUFFOUR, M.C. and FORNI, C. HPNS of the baboon during helium-nitrogen-oxygen slow exponential compressions. J. Appl. Physiol. : Respirat. Environ. Exercise Physiol. 1984 b, 57 : 341-350.
17. ROSTAIN, J.C., LEMAIRE, C., GARDETTE-CHAUFFOUR, M.C. and NAQUET, R. Evolution of HPNS in 16 divers breathing He-N2-O2 during long stays at 45 bars. A.J. Bachrach and M.M. Matzen eds. Underwater Physiology VIII, Undersea Medical Society, Bethesda. 1984 c, p 665-672.
18. ROSTAIN, J.C., LEMAIRE, C., GARDETTE-CHAUFFOUR, M.C. and NAQUET, R. Le SNHP au cours d'une plongée en mélange hélium-oxygène jusqu'à 610 mètres (ENTEX 9). In : G. Susbielle, M. Comet, M. Jacquin et R. Sciarli eds. Proceeding of Xth Congress of European Undersea Bio-Medical Society. EUBS, Marseille, 1984 d, p 19-30.
19. TOWNSEND, R.E. and HALL, D.A. Sleep, mood, and fatigue during a 14-day He-O2 open-sea saturation dive to 850 fsw with excursions to 950 fsw. Undersea Biomed. Res. 1978, 5 : 109-117.
20. WILCOX, R.H., SPENCER, J.W. and RUSSO, F. Sleep at 1200 fsw. in the University of Pennsylvania predictive studies IV project. Undersea Biomed. Res. 1976, 3 : A45.

« THIS DOCUMENT IS THE PROPERTY OF COMEX, all information contained herein may neither be reproduced, used, disclosed, transmitted nor in any way made public without the written permission of the owner, any person in possession of this document acknowledges being bound by the obligation to treat it as confidential »

PSYCHOMETRIC STUDY

C. LEMAIRE

OCTARES, 13008 Marseille

It is now well known that diving conditions can adversely affect the intellectual psychomotor performances of the diver. The degree to which they are affected depends upon several factors whose roles have been more or less ascertained. viz. :

- depth
- rate of access (as a function of depth)
- breathing mixture

The compression curve used for this dive was previously validated on 16 subjects in three experiments with a helium-oxygen breathing mix to which nitrogen was added at each stop. This method resulted in an average decrease in performance of 10 % for the Manual Dexterity test, 7 % for the Visual Choice Reaction Time, and 15 % for Number Ordination.

The same curve was also used with a helium-oxygen mix, but only for two subjects (ENTEX 9).

Since we had the opportunity to test this same compression curve with an untried mixture (Helium + Oxygen + Hydrogen), we used the same tests in order to be able to compare the effects of two different breathing gases for the same rates of access to 450 meters.

Very few references to psychometric measurements made in a hydrogen-base mixture are available in the literature, as few experiments have been carried out. The problem is to ascertain two phenomena : first of all, are the performances different on heliox and on hydrox; and second, is there such a thing as hydrogen narcosis ? The tests selected should make it possible to answer these question.

	66 m/s	450m A/10m	450 m A+ 24/10	200 m / 10
M.D.	- 9 %	- 5	- 4	0
V.C.R.T.	- 7 %	- 5	+ 1	+ 3
N.O.	-	- 3	+ 1	+ 21
P.M.P.	-	- 20	- 14	- 6

CONCLUSION

The results of the tests previously used for the same compression curve show definite improvement over the helium-nitrogen-oxygen mixture results. Furthermore, 24 hours after reaching the bottom there is total recovery for the alertness/concentration test and for the intellectual test of number ordination. For Manual Dexterity, as is commonly observed, there is no recovery evident during the bottom time and it can well be said that this really is due to the effect of the pressure itself, whereas the Reaction Time and Number Ordination are more sensitive to the effects of compression.

The behavior of the divers at times could lead one to believe that the test results would be mediocre. But actually they were perfectly capable of concentrating throughout the test period and of maintaining their performance levels.

For the psychomotor and mental promptness test, one which is perhaps more constraining for the subjects, the results are definitely lower than for the other tests, - 20 % on arrival at the bottom and - 14 % the next day. This test is much more sensitive to narcosis than the others - it was chosen for this reason - and there is normally a certain amount of difficulty in assimilating the instructions and performing the required operations quickly. The tests given during decompression show a return to normal without any problems resulting from the length of exposure.

THIS DOCUMENT IS THE PROPERTY OF COMEX, all information contained herein may neither be reproduced, used, disclosed, transmitted nor in any way made public without the written permission of the owner. any person in possession of this document acknowledges being bound by the obligation to treat it as confidential.

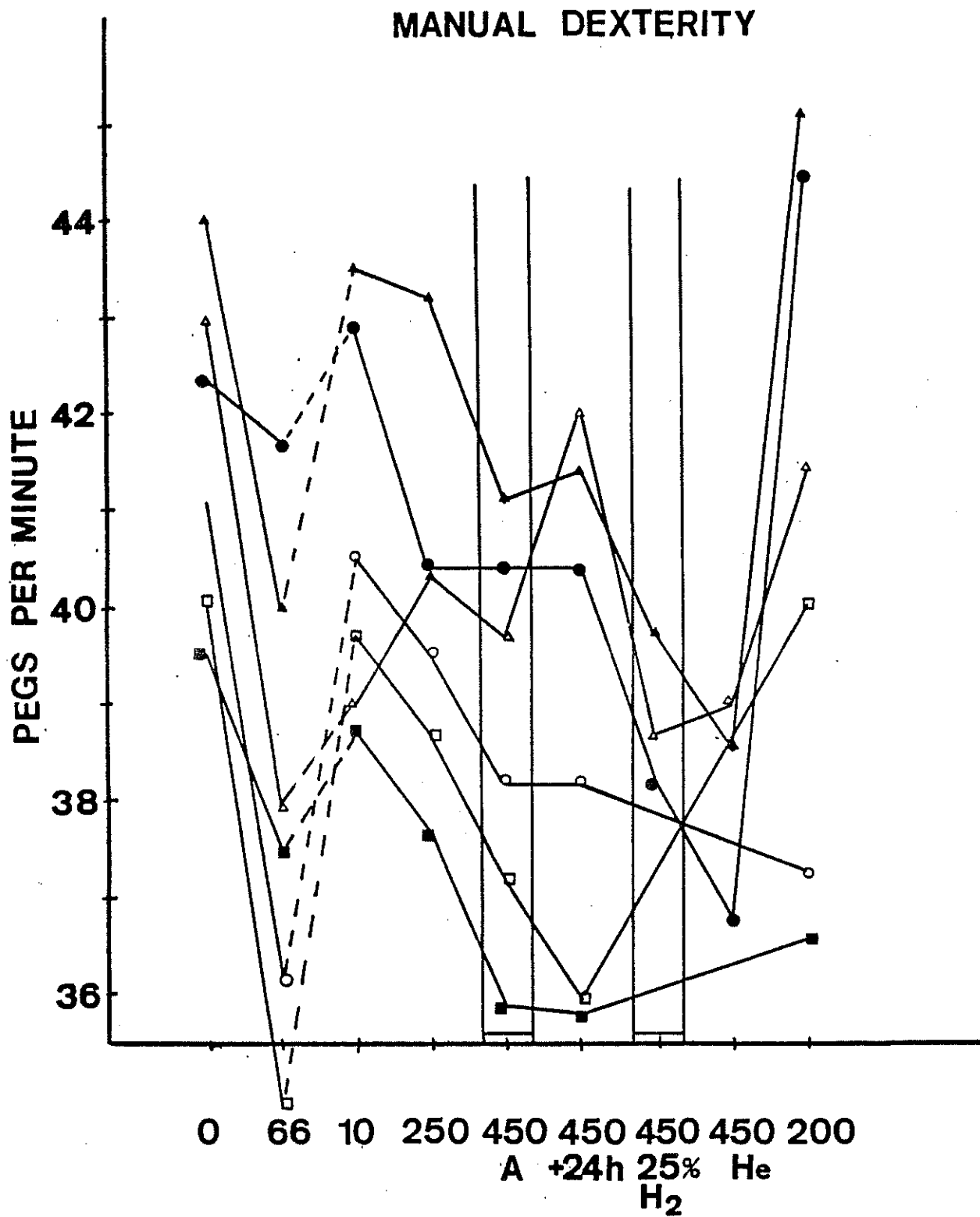

THIS DOCUMENT IS THE PROPERTY OF COMEX, all information contained herein may neither be reproduced, used, disclosed, transmitted nor in any way made public without the written permission of the owner, any person in possession of this document acknowledges being bound by the obligation to treat it as confidential.

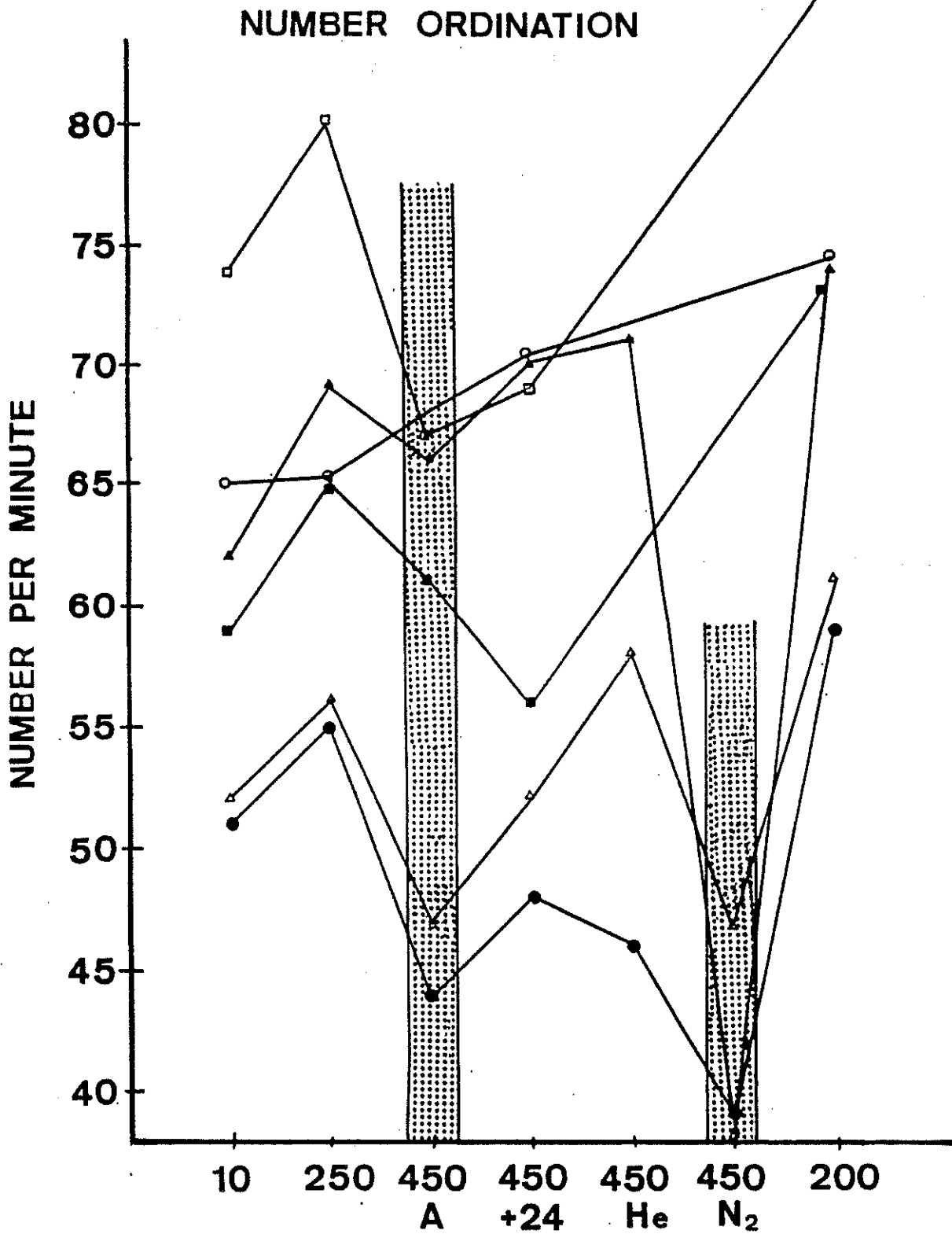

VISUAL CHOICE REACTION TIME

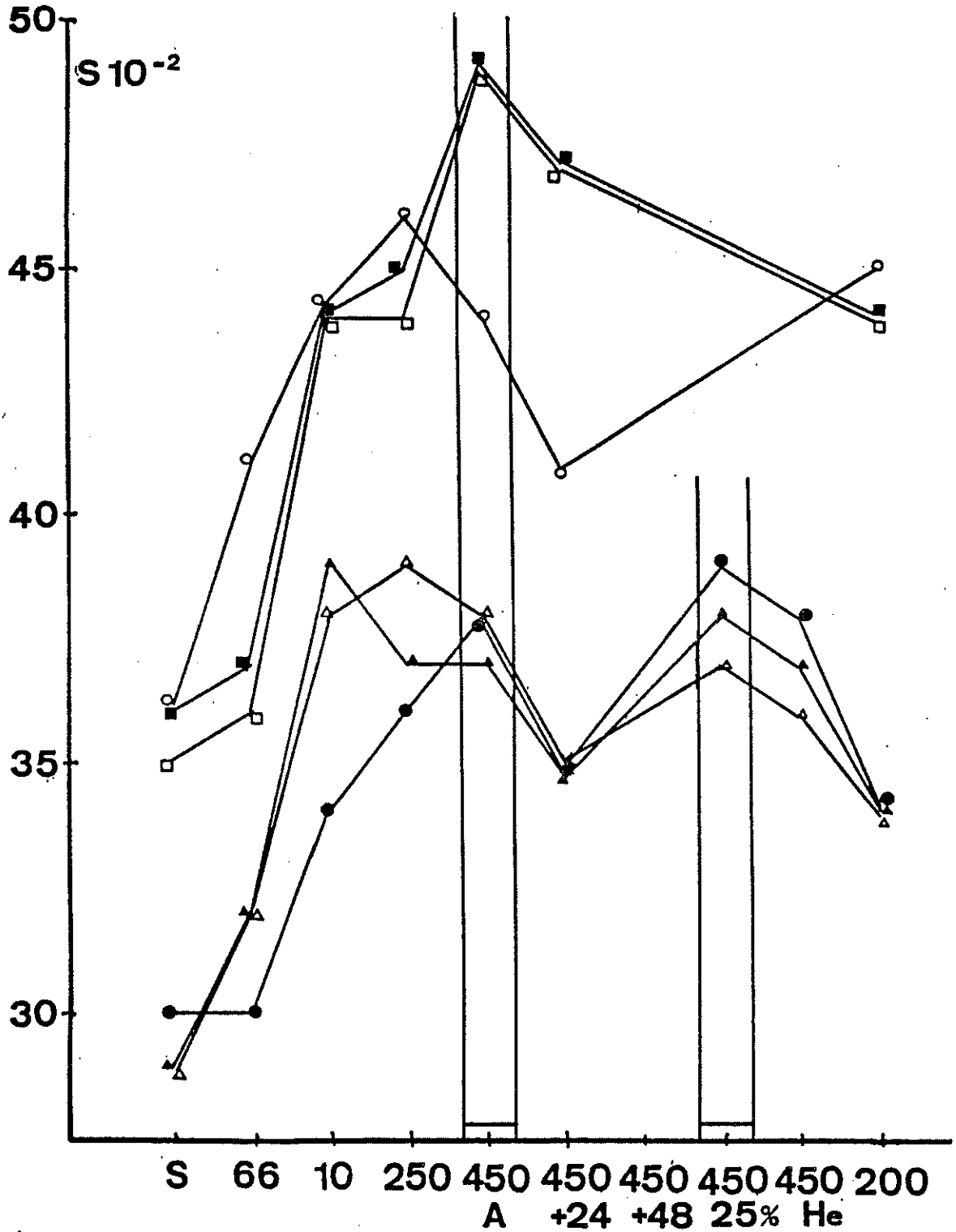

THIS DOCUMENT IS THE PROPERTY OF COMEX, all information contained herein may neither be reproduced, used, disclosed, transmitted nor in any way made public without the written permission of the owner. any person in possession of this document acknowledges being bound by the obligation to treat it as confidential.

HYDRA V

MEAN PERFORMANCE VARIATION

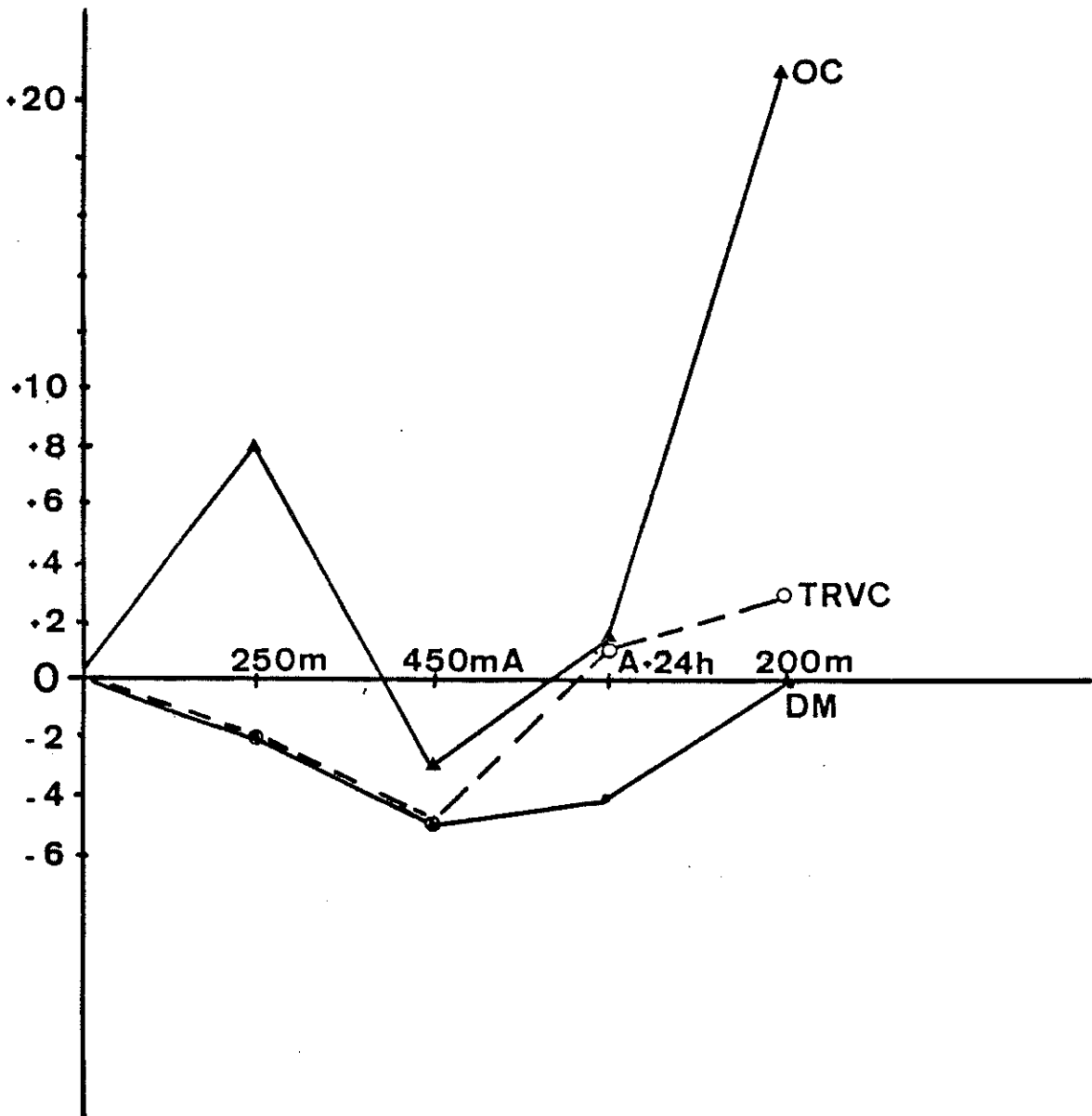

THIS DOCUMENT IS THE PROPERTY OF COMEX, all information contained herein may neither be reproduced, used, disclosed, transmitted nor in any way made public without the written permission of the owner, any person in possession of this document acknowledges being bound by the obligation to treat it as confidential.

HYDRA V

PSYCHOMETRIC STUDIES

Martine Carlioz, COMEX Marseille

Hans Ornham, SWEDISH NAVY

INTRODUCTION

In 1983 the effect of hydrogen narcosis on human beings was described for the first time when 6 divers were given a hydrogen-oxygen breathing mixture (98/2) called hydrox. Although it seems as if this hydrogen narcosis (Fructus et al., 1985; Carlioz et al., 1985; Adolfsen et al., 1985) limited the use of pure hydrox to 200 m or less, it did not preclude the use of hydrogen in divers' breathing gas. For even when used with helium, the decrease in gas density, the principal object of this research, is still sufficient to make it worth while. Furthermore the antagonism pressure-narcosis (Miller, 1977) could make it possible to consider the use of a light narcotic gas (hydrogen) at high pressures.

The HYDRA V (May-June 1985) experiment was the first in which divers were compressed and saturated on a hydrogen-helium-oxygen mixture (55/44/1) at 450 m. Six divers participated in the experiment. Three of them tested a switch of breathing gas without change of pressure and the other three were decompressed to 200 m in the hydrogen mixture.

Hydrogen narcosis was studied by clinical observation, subjective questionnaires filled in by the divers, and psychophysiological tests by three different teams of scientists. Our group used the same tests as those used for our earlier hydrogen dives :

- The Number Similarities (NS) and Multiplications (M) tests used by Bennett (Bennett and Blenkarn, 1974; Bennett et al., 1982) in the study of nitrogen narcosis and by Carlioz et al. (1984) during COMEX's Hydra IV dive in November 1983.
- The Paced Auditory Serial Addition Test (PASAT) and a Visual 4-Choice Reaction Time (VCRT) test used in the Hydrox A dive carried out at the Swedish National Defence Research Institute in December 1983 (Adolfsen and Ornhagen, 1984).

One of these, the VCRT, is a psychomotor test; the others assess the cognitive functions.

MATERIAL AND METHODS

1 - Subjects

Six divers participated in the experiment, 3 from COMEX, 2 from the FRENCH NAVY and 1 from the INPP (Institut National de Plongée Professionnelle). They were divided in 2 teams, A and B. Team A was composed of 3 divers who had already participated in dives to 450 m on a 5 % trimix, whereas only one of the divers in team B had been at this depth before.

Table 1 below gives some of the relevant information concerning the divers.

TABLE 1

Diver	Age (years)	Previous experience
A1	40	6500 dives for the French Navy 1 experimental dive : ENTEX 5
A2	35	Professional diver for COMEX since 1977 2 experimental dives : JANUS IV and ENTEX 9
A3	34	Professional diver for COMEX since 1977 2 experimental dives : JANUS IV and HYDRA IV
B1	32	3500 dives for the FRENCH NAVY 1 experimental dive : preparation for ENTEX 9
B2	31	Professional diver for COMEX since 1979 1 experimental dive : ENTEX 5
B3	33	Diving instructor at INPP Air dives

2 - Hyperbaric complex

The hyperbaric facilities were those of COMEX's Hyperbaric Research Center comprising :

- 3 spheres (volume = $7 \text{ m}^3 \times 3$; internal diameter = 2.5 m) fitted out for hydrogen use and designed for a maximum of 3 divers, with a very limited degree of comfort. In fact, only 2 of the divers had bunks to sleep on, the third slept on a mattress on the floor of the living sphere.
- a comfortable 6-person chamber used for the heliox phase (volume = 33 m^3 ; internal diameter = 2.5 m)

3 - Dive profile

a) For team A

- 2 days confinement at 10 m depth in heliox 80/20.
- compression from 10 m to 450 m in 38 hours, in helium to 200 m, then in hydrogen.
- bottom time at 450 m: 63 hours in mixture composed of 56 % H_2 , 0,9 % O_2 and helium (mean $\text{PH}_2 = 25.8 \text{ bar}$; mean $\text{PO}_2 = 0.4 \text{ bar}$), 8 hours in mixture composed of 30 % H_2 , 0.9 % O_2 and helium (mean $\text{PH}_2 = 13.8 \text{ bar}$), 172 hours in heliox (0.9 % O_2) of which 54 hours at more than 450 m.

- decompression in heliox at a rate of 1.33 m/h (or 45 min/m) from 450 m to 15 m, then 1 m/h from 15 m to the surface. The PO_2 was increased to 0.6 bar from 450 to 350 m, then kept at 0.5 bar up to 120 m, then increased to 0.6 bar up to 15 m, where the oxygen percentage was 24 %. The total decompression time was 14 days 5 hours and 15 minutes.

b) For team B

- confinement and compression same as for team A.
- bottom time at 450 m : 104 hours in a mix of 54 % H_2 , 0,9 % O_2 and helium (mean $PH_2 = 24.8$ bar; $PO_2 = 0.4$ bar).
- decompression in hydrogen mixture to 200 m with gradual elimination of hydrogen, then in heliox up to the surface, at the following rates of speed :

0.86 m/h (or 70 min/m)	from 450 to 350 m
0.92 m/h (or 65 min/m)	from 350 to 300 m
1.00 m/h (or 60 min/m)	from 300 to 250 m
1.09 m/h (or 55 min/m)	from 250 to 15 m
0.50 m/h (or 120 min/m)	from 15 m to the surface.

The PO_2 was increased to 0.5 bar from 450 m to 100 m, then to 0.6 bar from 100 to 15 m, where the O_2 percentage was increased to 24 % up to the surface. Total decompression time was 19 days 10 hours and 15 minutes.

4 - Nitrox dive

During the pre-dive training period, dives to 66 m in nitrox 95/5 were carried out in a smaller chamber in order to obtain references for nitrogen narcosis equivalent to 80 m on air ($PN_2 = 7.2$ bar). Compression took 3-4 minutes, compression plus bottom time was 20 minutes, and decompression with stops took 2 hours.

5 - Trimix tests at 450 m

The 3 members of team A were given a trimix containing 16.9 % nitrogen ($PH_2 = 7.8$ bar) for 40 minutes by mask during the saturation in heliox. The purpose of the test was to study the effects of similar PN_2 at different depths.

6 - PSYCHOMETRIC TEST PROTOCOL

Most of the tests used to evaluate narcosis involve the higher cerebral functions. This means that the number of the practice tests has to be balanced to avoid learning effects and lost motivation due to boredom. It was decided that

10 training rounds in the laboratory, 2 pre-dive controls in the chamber in heliox at 10 m and 5 "post-dive" controls at the end of the decompression should be sufficient. Decrease in performance is based on individual comparisons and the Student t test for paired series is used to determine the degree of significance.

The 4 tests were given at each session in the following order :

- Number Similarities (1 min)
- Multiplications (2 min)
- Paced Auditory Serial Addition Test (4 min)
- Visual Choice Reaction Time (4 min)

a) Number Similarities (NS)

The NS test measures alertness and the capacity for instantaneous observation (Bennett et al., 1982). The subject looks at 40 pairs of numbers containing from 5 to 9 digits and checks with a pencil a box for each pair where the number on the right differs from the number on the left. 6 different test sheets are used to avoid memorization. The number of figures examined in one minute and the number of mistakes are recorded.

b) Multiplications (M)

The M test has been used by several investigators to study air narcosis (Bennett and Blenkarn, 1974; Adolfson, 1965). In our study the subject has 2 minutes to solve with a pencil as many as possible of multiplication problems on one sheet of paper containing 40 problems of 2 digits X 1 digit with carry-over. Numbers 0, 1, 5 and multiples of 11 are not used. 11 different sheets of tests were used to avoid memorization. The number of problems solved in 2 minutes and the number of error are recorded.

c) Paced Auditory Serial Addition Test (PASAT)

The PASAT is a mental arithmetic test which has been used clinically to measure the rate of information processes and which has been found to be a convenient test for estimating individual performance during recovery from concussion (Gronwall and Wrightson, 1974; Gronwall, 1977). The PASAT has also been used earlier to study narcosis while diving (Adolfson and Ornhagen, 1984; Linér et al., 1985). The subject is from a tape recorder, via headset, exposed to a unit digit every 2 seconds. The task is to add the 2 latest digits and deliver the answer orally. Thus, the 2nd figure is added to the 1st, the 3rd to the 2nd and so on. For this study 15 series of 70 digits was used. The experimenter evaluates the subjects' performance by counting the correct answers, the wrong answers and the omissions. The replies are also recorded in order to double-check the results later on and reduce the possibility of

investigator error due to misunderstanding or misinterpretation.

d) Visual Choice Reaction Time (VCRT)

The VCRT test with 4 choices is a more complex test than the VCRT with no choice used by Shilling and Willgrube (1937) or with 2 choices used by Kiessling and Maag (1962). A similar VCRT was used for previous experiments with hydrogen exposure (COMEX, 1984). Adolfson and Ornhagen (1984) used a 4-choice VCRT for hydrox exposure at 120 m depth, and the same test was studied here. This 4-choice VCRT uses 4 Light-Emitting Diodes (LEDs) placed in the 4 corners of a square drawn on a box. These LEDs are programmed by a micro computer program to light up at random. The test was to push a lever, mounted on the box, towards the lit LED. The reaction time for pushing the lever in the right direction is measured by the computer in milliseconds (msec) and responses in the other 3 directions are counted as mistakes. The subject is exposed to 80 light stimulations in each session, which are random as far as both direction and timing are concerned.

e) Test given during dive

Figure 1 shows the dive profile with the schedule of the psychometric tests given. During the nitrox dive to 66 m there were 3 test sessions in the air chamber :

- at the surface before diving
- during bottom time at 66 m
- during decompression stop at 15 m.

The PASAT and the VCRT were not given because the bottom time was only 20 minutes.

RESULTS

Figure 2 (A, B, C and D) shows the mean performances of the 6 divers \pm Sd on the 4 psychometric tests by day and experimental conditions. The individual results and the curves of the 6 divers are given in the appendix.

Figure 2A : performances on NS test expressed in number of figures examined in 1 minute, and number of errors.

Figure 2B : performances on M test expressed in number of multiplications solved in 2 minutes, and number of errors.

Figure 2C : performances on PASAT expressed in number of correct additions (c), number of omissions (o), and number of errors (e).

Figure 2D : performances on VCRT expressed in milliseconds (msec) and number of errors.

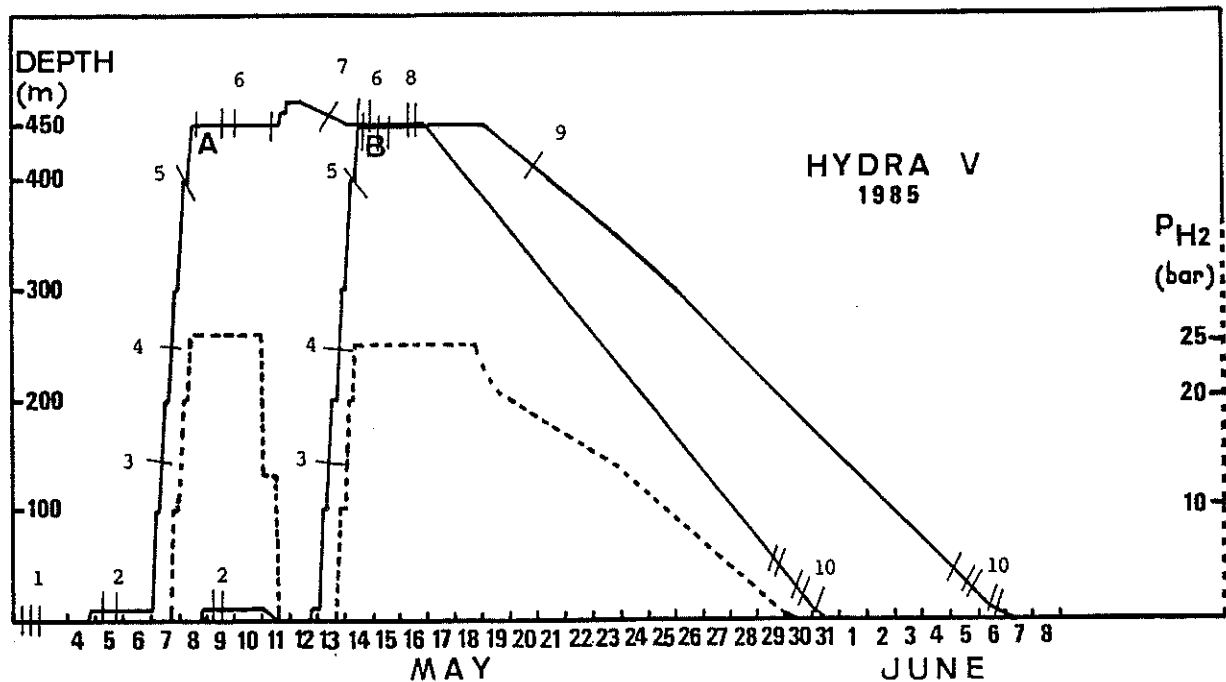

Figure 1

HYDRA V dive profile and P_{H_2} , and schedule of the psychometric tests :

- 1 Practice runs at surface in laboratory
- 2 Reference tests in chamber at 10 m in heliox
- 3, 4, 5 Tests during compression at 142, 245, and 400 m
- 6 Tests in hydrox at 450 m
- 7 Tests in heliox at 450 m (team A)
- 8 Tests on heliox, then on trimix with N_2 at 450 m with mask (team A) :
Number Similarities and Multiplications
- 9 Tests at the start of hydrogen decompression at 420 m (team B)
- 10 "post-dive" control tests at the end of decompression (heliox)

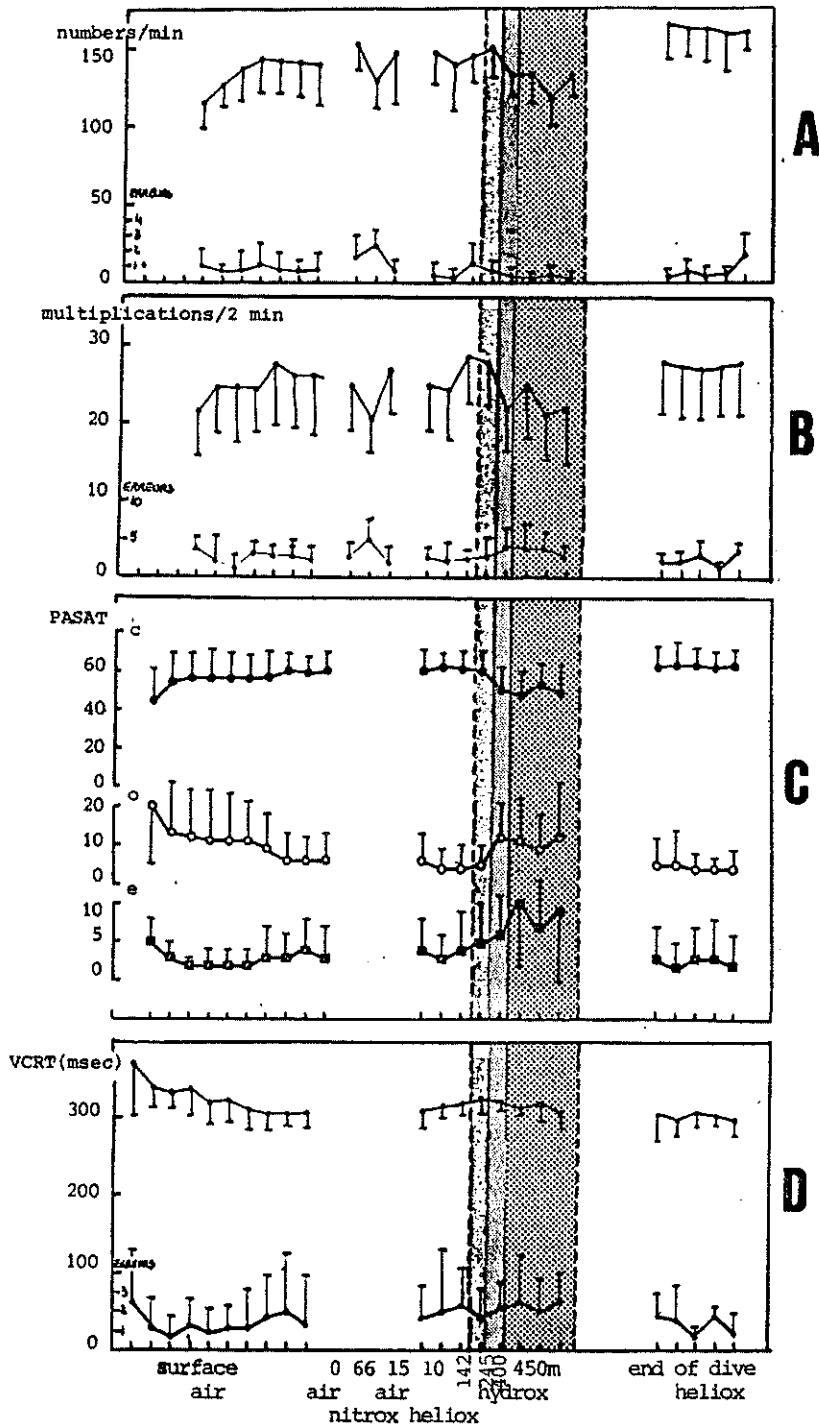

FIGURE 2

Mean performance of the 6 divers of Hydra V \pm Sd on the 4 psychometric tests.

- PH2 = 5 bar
- PH2 = 20 bar
- PH2 = 25 bar

- A : performances on Number Similarities test expressed in number of figures examined in 1 minute and number of errors.
- B : performances on Multiplications test expressed in number of multiplications solved in 2 minutes and number of errors.
- C : performances on Paced Auditory Serial Addition Test expressed in number of correct additions (c), number of omissions (o) and number of errors (e).
- D : performances on Visual Choice Reaction Time in thousandths of seconds (msec) and number of errors.

1 - Number Similarities

Figure 3 (A and B) shows the mean variation of the performances shown in Fig. 2 in percentage relative to the reference value (average of 2 tests at 10 m in heliox for Fig. 3A. The reference value for tests with nitrogen shown in Fig. 3B is the result obtained immediately preceding the nitrogen exposure).

The test is effectively learned in 4 sessions and the performances in heliox at 10 m do not differ significantly from the pre-dive tests. During the nitrox 95/5 dive to 66 m the mean deterioration for the divers relative to the surface references in the chamber was 16 % ($P < 0.01$) but the reference value was higher than the average level of performance at the surface. The deterioration in performance is pronounced for 5 out of the 6 divers. Diver B3 showed little variation except for an increase in the number of errors. The tests carried out during compression do not show any significant variations until 245 m. Deterioration is noticeable from 400 m on but it does not become significant until the second test at 450 m ($P < 0.02$). For the 3 subjects who changed gas at 450 m (hydrox 56 % \rightarrow hydrox 30 % \rightarrow heliox) a somewhat higher performance was recorded in the 30 % H_2 mixture and in heliox. The difference between the mean performances in hydrox 56 % and heliox at 450 m for the entire series of tests is 12 % . The performances of the 3 subjects in heliox at 450 m does not show any difference from the performances at 10 m (-1 %).

At 450 m 3 subjects breathed by mask first heliox and then trimix with 16.9 % N_2 . The performance in the NS test was $-4 \% \pm 19$ when breathing trimix, which is considerably less than the mean reduction for the same 3 subjects during the 66 m dive on nitrox : $18 \% \pm 2$. The corresponding value for the whole groupe was $-16 \% \pm 7$ ($P < 0.01$).

At the end of the decompression the NS tests show significantly higher performances than in the control situation ($P < 0.05$; $P < 0.01$).

2 - Multiplications

Figure 4 (A and B) gives the results in the form of percentage of variation (mean \pm Sd) relative to the reference value (average of 2 tests at 10 m in heliox for Fig. 4A. The reference value for tests with nitrogen shown in Fig. 4B is the result obtained immediately preceding the nitrogen exposure). The practice sessions at the surface get progressively better (see Fig. 2B) and the values in the confinement at 10 m are close to the averages for the practice period. A deterioration averaging $16 \% \pm 10$ is observed for this test during the nitrox 95/5 dive to 66 m ($P < 0.05$), particularly clear for 4 of the 6 divers. For the other 2 the variation showed up mainly as an increase

Performance variation in percentage (%)

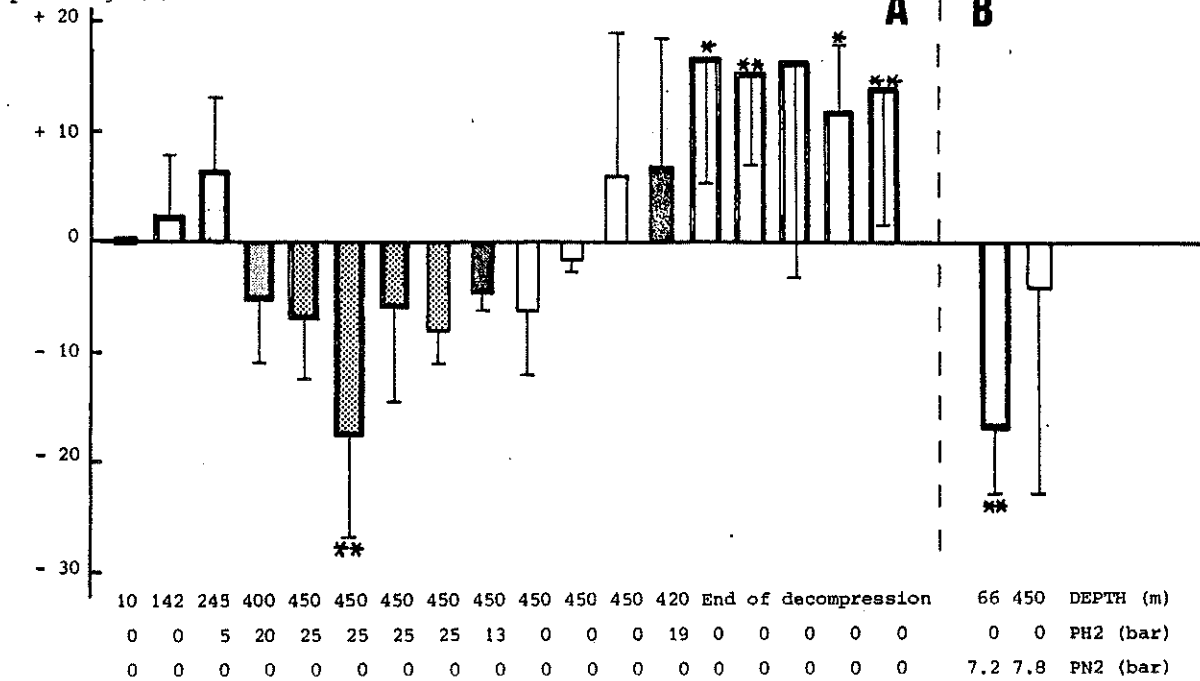

Figure 3 (A and B)

Mean variation of the performance (\pm Sd) on Number Similarities test in percentage relative to the reference value (average of the 2 tests at 10 m on heliox for Fig. 3A, preceding test for Fig. 3B - For details, see the text) for the 6 divers of HYDRA V , or for only 3 divers .

* P < 0,05

** P < 0.01

*** P < 0.001

© THIS DOCUMENT IS THE PROPERTY OF COMEX, all information contained herein may neither be reproduced, used, disclosed, transmitted nor in any way made public without the written permission of the owner, any person in possession of this document acknowledges being bound by the obligation to treat it as confidential.

Performance variation in percentage (%)

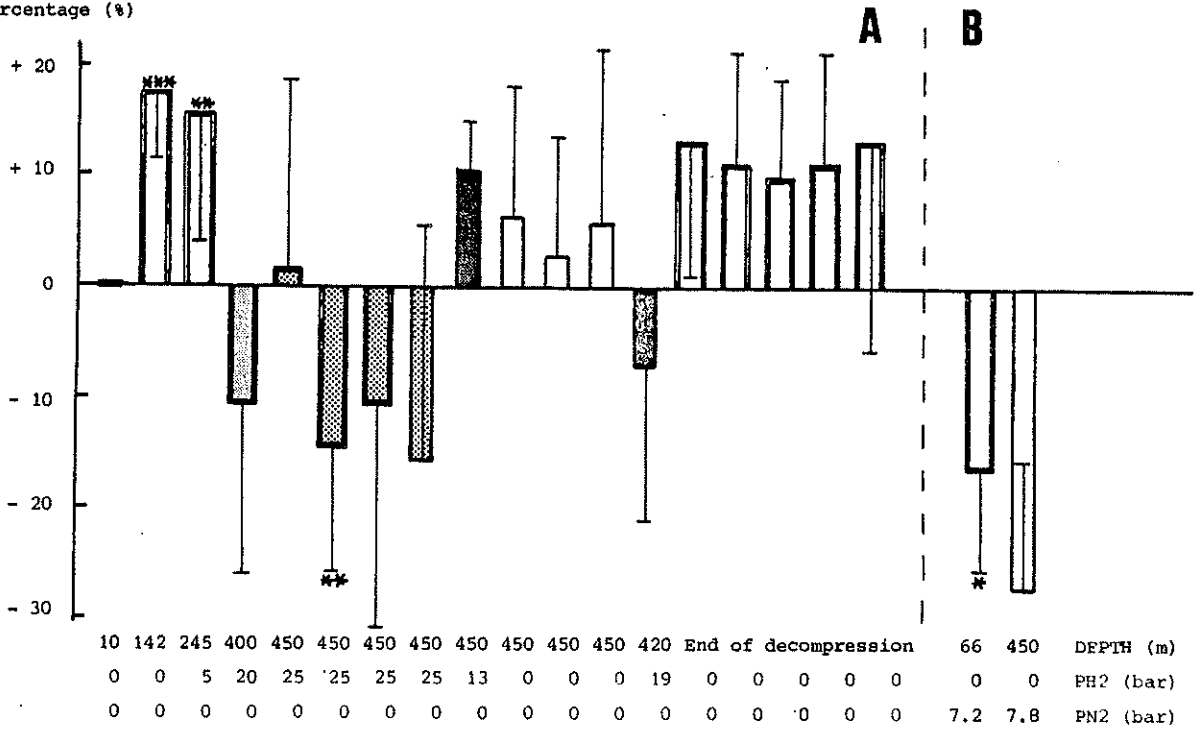

Figure 4 (A and B)

Mean variation of the performance (\pm Sd) on Multiplications test in percentage relative to the reference value (average of the 2 tests at 10 m on heliox for Fig. 4A, preceding test for Fig. 4B - for details, see the text -) for the 6 divers of HYDRA V , or for only 3 divers .

* P < 0.05

** P < 0.01

*** P < 0.001

« THIS DOCUMENT IS THE PROPERTY OF COMEX, all information contained herein may neither be reproduced, used, disclosed, transmitted nor in any way made public without the written permission of the owner, any person in possession of this document acknowledges being bound by the obligation to treat it as confidential. »

in the number of errors. The degree of deterioration appears less, however, since the reference test results in the chamber were somewhat low. During hydrox saturation there was considerable individual variability from day to day as well as considerable variability among the individual subjects. But the increase of the PH_2 at 400 m and 450 m produced significant deterioration ($P < 0.01$) in the results only for one test at 450 m. The 3 divers who switched from hydrox to heliox at 450 m showed improvement in performance in the intermediate gas, which continued in heliox afterward. The percentage of mean variation between hydrox 56 % and heliox at 450 m was 19 %. When breathing trimix with nitrogen at 450 m the 3 divers showed an average deterioration in test results of $-27 \% \pm 12$. For a similar PN_2 , but at 66 m, the deterioration for the same 3 divers was $-22 \% \pm 6$.

The measurements at 420 m at the beginning of the decompression for 3 divers who had spent more than 4 days in hydrox was : -7% compared to the reference value at 10 m.

At the end of decompression the 6 divers have recovered their pre-dive performances with a more stable response to the test.

3 - Paced Auditory Serial Addition Test

Figure 5 shows the same results as Figure 2C but expressed as mean percentage of variation \pm Sd from control (mean value of 2 tests at 10 m in heliox) in the number of correct additions. The PASAT could not be given during the nitrox dives and trimix breathing at 450 m for technical reasons (too short bottom time, communication problems).

We did observe the following :

- good mastery of test in surface practice sessions;
- during compression, a gradual decline in performance, accentuated at 400 m ($-17 \% ; P < 0.01$) and then at 450 m in hydrox ($-23 \% ; P < 0.01$). 24 hours following arrival at 450 m, no improvement was noticeable ($-21 \% ; P < 0.05$).
- a difference in performance of the two teams (team A : 2 subjects had more or less reduced performances; team B : the 3 subjects had a decrease of performances) and a considerable individual variation among the divers;
- a difference in the response of the subjects : the performance of some declined by virtue of an increase in the number of errors, others by an increase in the number of omissions, others by an increase in both.
- at the end of decompression all 6 divers had completely returned to their earlier surface performances on the PASAT.

THIS DOCUMENT IS THE PROPERTY OF COMEX. All information contained herein may neither be reproduced, used, disclosed, transmitted nor in any way made public without the written permission of the owner. Any person in possession of this document acknowledges being bound by the obligation to treat it as confidential.

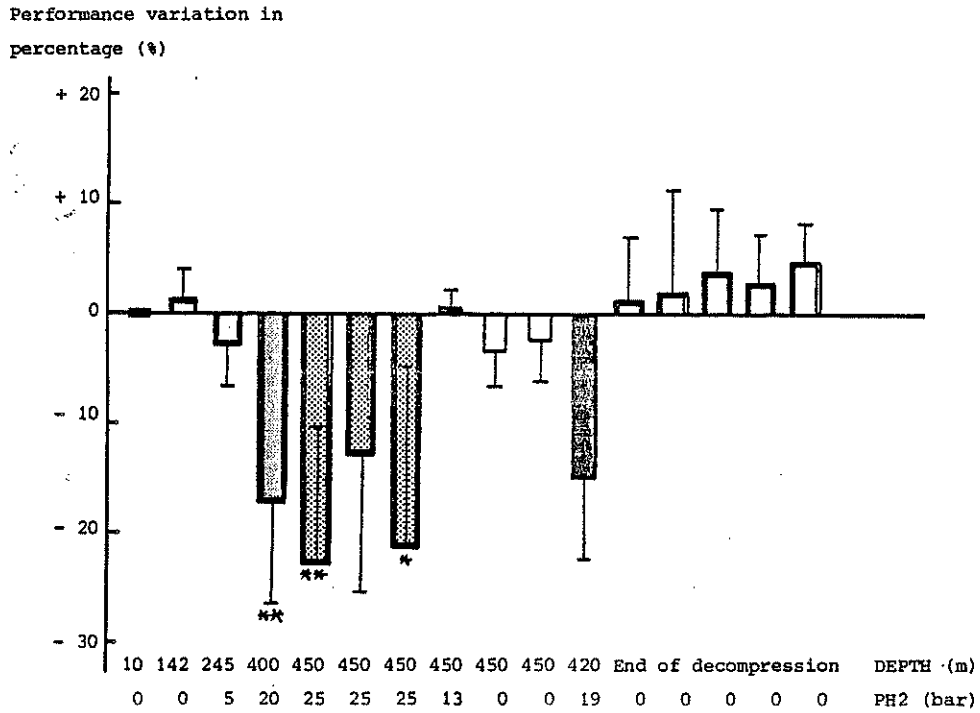

FIGURE 5

Mean variation of the performance (+ Sd) on Paced Auditory Serial Addition Test expressed in number of correct additions, in percentage relative to the reference value (average of the 2 tests at 10 m on heliox) for the 6 divers of Hydra V , or only for 3 divers .

- * P < 0.05
- ** P < 0.01
- *** P < 0.001

4 - Visual Choice Reaction Time

Figure 6 gives the results of the VCRT in the form of percentage of variation relative to the reference value (average of 2 tests in heliox at 10 m). An increase in reaction time is scored as a negative variation. We did observe :

- mastery of the test at surface is gradual but clear (see Fig. 2D)
- the slight variations observed thereafter during the dive are not significant (+2 to -2 % at 450 m in hydrox). The stay in hydrox at 450 m did not significantly affect the VCRT results.
- for the 3 divers who switched from hydrox to heliox at 450 m there seemed to be a greater decline in VCRT results in heliox as the variations found were :
 - 3 % at 450 m in 30 % hydrox
 - 7 % at 450 m in heliox (48 h after the switch)
 - 12 % at 450 m in heliox (72 h after the switch)
- at the end of decompression the performances were the same as for the pre-dive surface tests.

5 - Comparison of the 4 tests and clinical observations

Figures 7 and 8 show a comparison of the 4 psychometric tests used. Fig. 7 gives the percentage of variation in performance compared to 10 m in heliox for the 4 tests as function of the PH_2 of the breathing mixture. The performance on the VCRT test is the least affected, and the PASAT performance the most affected. The performance on NS and M tests are affected by the experimental conditions in about the same way. The deterioration observed for the PASAT seems to be proportional to the PH_2 . Fig. 8 shows the percentage of variation in performance for the 4 tests comparing results from the arrival at 450 m and 24 h later. The performances on these tests do not improve after 24 h at 450 m, the performance levels remain poor for the NS and the PASAT or become poor (M).

The performances of the NS and M tests could be compared with the performances observed during HYDRA IV under a similar PH_2 at 240 m (COMEX, 1984). For the NS test at 240 m with a $PH_2 = 24.5$ bar the decrease of performance in 6 divers was 6 %, and during HYDRA V at 450 m ($PH_2 = 25.5$ bar) 11 %. For the M test, the decrease of performance was 20 % during HYDRA IV but only 9% during HYDRA V. It appears that for the M test the narcosis experienced by the divers during HYDRA V at 450 m was not so pronounced as at 240 m under the same PH_2 , but this is not shown by the NS test.

The slight but definite narcosis which showed up in hydrox at 450 m depth was also revealed by the divers behavior, which is briefly analysed here. The normally serious and well-motivated compartment of the divers during the tests was slightly affected deeper than 400 m. At 450 m there was, however, a difference in the 2 teams. In team A no diver noticed narcosis, however

« THIS DOCUMENT IS THE PROPERTY OF COMEX, all information contained herein may neither be reproduced, used, disclosed, transmitted nor in any way made public without the written permission of the owner, any person in possession of this document acknowledges being bound by the obligation to treat it as confidential».

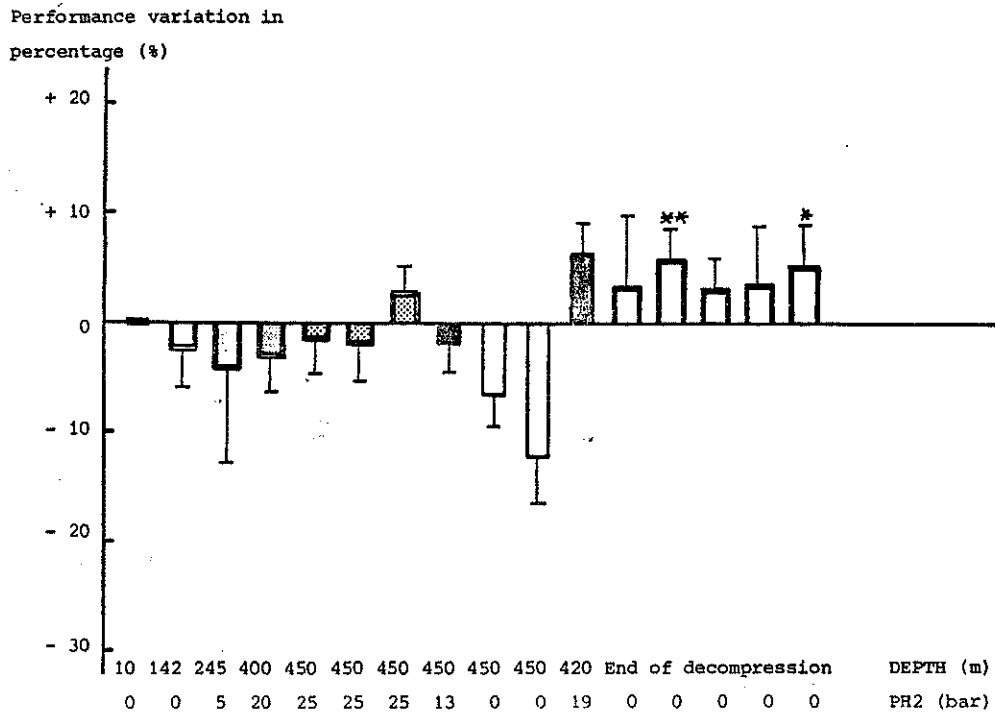

FIGURE 6

Mean variation of the performance (+ Sd) on Visual Choice Reaction Time test in percentage relative to the reference value (average of the 2 tests at 10 m on heliox) for the 6 divers of Hydra V

▨ , or only for 3 divers ▨ .

- * P < 0.05
- ** P < 0.01
- *** P < 0.001

« THIS DOCUMENT IS THE PROPERTY OF COMEX, all information contained herein may neither be reproduced, used, disclosed, transmitted nor in any way made public without the written permission of the owner, any person in possession of this document acknowledges being bound by the obligation to treat it as confidential. »

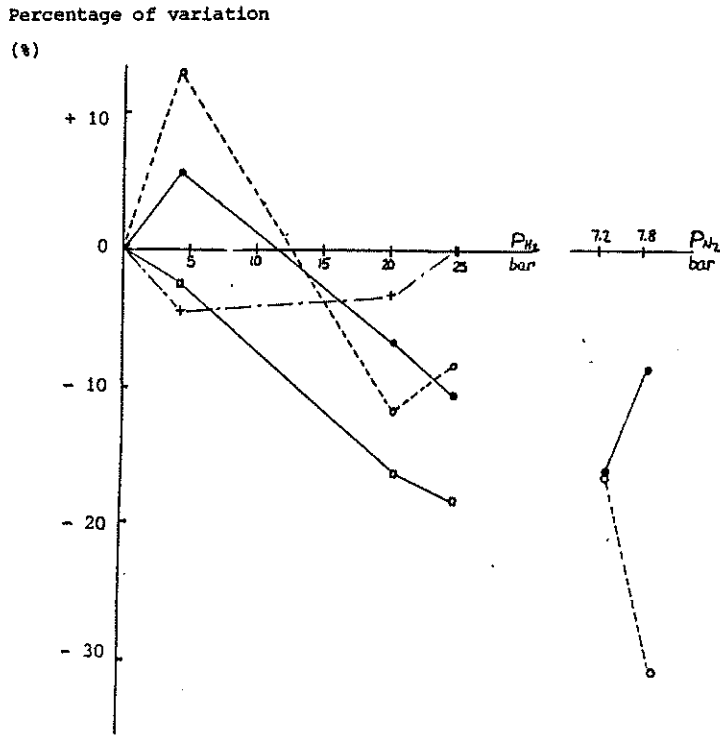

FIGURE 7

Percentage of variation in performance for the 4 tests as function of the PH₂ of the breathing mixture compared to 10 m on heliox, and of the PN₂ compared to the preceding test.

- Number Similarities test
- - -○ Multiplications test
- Paced Auditory Serial Addition Test
- + - - -+ Visual Choice Reaction Time

FIGURE 8

Percentage of variation in performance for the 4 tests compared to the reference at 10 m on heliox as against the arrival at 450 m on hydrox and 24 h later.

- Number Similarities test
- - -○ Multiplications test
- Paced Auditory Serial Addition Test
- + - - -+ Visual Choice Reaction Time

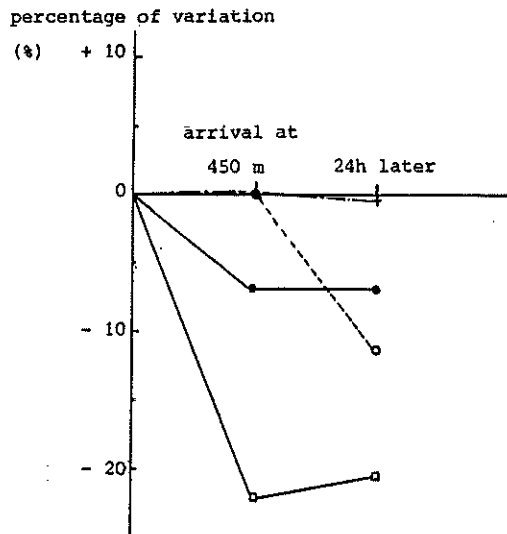

the behavior of one diver indicated a slight narcosis, whereas in team B all 3 divers felt a slight narcosis. Some of the divers were obviously euphoric, others simply had trouble concentrating on the tests. Two divers were so "relaxed" that they wanted to take the PASAT laying down instead of sitting as all tests had been performed earlier. After a few instructions from the surface personnel they settled down and took the test more normally, but 4 of them were aware of their difficulty in concentrating. The PASAT had to be started over twice because the divers had lost their train of thought and were unable to catch up with the progression of the test.

The narcosis did not seem to disappear or lessen, during hydrox saturation. The divers' behavior remained somewhat variable from one day to another. But with a littler will-power or stimulation and motivation from the outside they were quite capable of controlling themselves.

DISCUSSION

1 - Multifaceted influences

Interpretation of the results of these 4 psychometric tests is a rather delicate task in view of the complex experimental conditions and the simultaneous influence of several different factors (compression, confinement, gas, temperature, etc..). In addition, the results of the other psychometric and psychophysiological tests used in this dive are not always comparable. It is also difficult to apply statistical methods to such a limited sample : 6, or even 3 divers, depending on the case.

a) Environmental factors not particular to diving

Confinement

The influence of confinement is related to the length of time in confinement. In our study there was no difference between performances on reference tests at 10 m in heliox and the pre-dive surface values, except in the Multiplications test (see Fig. 2). It would not appear that confinement is responsible for the decline in this case, as the results of the same test at 142 and 245 m were close to the pre-dive performances. Thus confinement in itself was not a significant factor during the first 3 days in the chambers. At the end of the dive the divers, still confined, albeit in a larger chamber had performances similar to the surface results and those of the beginning of the dive. Confinement does therefore not appear to affect the test results. The divers were nevertheless subjectively quite sensitive to the lack of comfort of the small spheres.

Test time

Although there is no statistical evidence, due to the small number of

divers and test occasions, it would seem that performances on tests were better in the afternoon than in the morning. This observation is substantiated by the subjective impressions of some of the divers who had more trouble of concentrating in the morning than in the afternoon, and accords with the observations concerning the influence of circadian rhythm on psychometric tests (Fröberg, 1975).

Length of time at maximum pressure

- For team A : no significant changes in the tests were observed after 2.5 days in hydrox at 450 m

- For team B : no tests were made on the bottom just before decompression began.

The results of the tests at 420 m with a decreased PH_2 (19 bar) are not sufficient to draw any conclusions concerning adaptation to narcosis.

Temperature

The comfortable temperature in hydrogen is slightly higher than in helium (Smith, 1974). The problem of temperature control is as thorny with hydrox as with heliox and minor variations of temperature and comfort may have affected the test results. No tests were performed during a short period of uncomfortable low temperature the first morning at maximum pressure.

b) Factors peculiar to diving

Compression and pressure

Rapid compression to great depth is usually accompanied by a decrease in performance which is part of the HPNS (High Pressure Nervous Syndrome). The compression profile for this dive to 450 m was relatively slow and was used previously for

- DRET 79/131 dive (Rostain et al., 1980)
- ENIEX 5 dive (DRET, 1982)
- ENIEX 8 dive (DRET, 1984a)
- ENIEX 9 dive (DRET, 1984b)

Unfortunately our series of tests was not used during those dives and there is therefore no basis for direct comparison. Our subjective evaluation, however, is that the divers were in better shape during HYDRA V than during these preceding dives (in heliox or trimix) where the pressure was high enough to cause decline in psychometric test performances (Lemaire, 1980).

Gas

As a result of previous studies (Ornhagen, 1979; Brauer et al., 1982) it is known that helium has little or no biological effect on the organism, and that hydrogen has a certain narcotic potency (Brauer and Way, 1970; Fructus et al., 1984; Gennser and Ornhagen, 1985). In the present dive the

variations in performance observed could be due to compression, to pressure, to the gas, or to the combined effects of all three. Unfortunately our series of tests has to our knowledge not been used during dives having a similar profile or during a heliox dive, and thus it is impossible to differentiate the effects of these factors. The M and NS tests were used by Bennett et al. (1982) for deep dives in trimix to study nitrogen narcosis. Nevertheless the divers' self-observations as well as their behavior and test performances tend to indicate that the gas mix used at 450 m (55 % H₂/44 % He/1 % O₂) had a slight narcotic effect. The rate of introduction to a given P_{H₂} seems to have some effects on the impairment of the performances observed. The comparison of the results of the NS and M tests during HYDRA IV at 240 m and HYDRA V can support such an hypothesis. During HYDRA IV, the 6 divers were exposed suddenly to a P_{H₂} of 24.5 by means of a change of breathing medium. During HYDRA V, the 6 divers were compressed in hydrogen from 200 to 450 m (P_{H₂} = 25.5 bar) in 26 hours. The difference of deterioration on the M test (-20 % in HYDRA IV; -8 % in HYDRA V) could be caused by the slower rate of introduction to a similar P_{H₂}. For the NS test we cannot draw the same conclusion because of the small impairment observed in HYDRA IV.

2 - Appropriateness of tests for studying narcosis

A narcosis more or less proportional to the partial pressure of hydrogen was expected. The tests we used for HYDRA V, were easy to use in a hyperbaric context and had been used previously by Adolfson (1965) and Bennett and Blenkarn (1974), for studying nitrogen narcosis and by Carlnoz et al. (1985) and Adolfson and Ornhagen (1984) for studying hydrogen narcosis.

The PASAT seems to be the most sensitive of these tests, (see Fig. 7) but the NS also shows significant variations in 25 bar of hydrogen (see Fig.3). The broad individual differences in the Multiplications and Number Similarities test results may be imputed to variations in the power of concentration of the subjects, which is corroborated by the divers' own statements. The VCRT does not vary as a function of P_{H₂} and P_{He}, which is in agreement with previous findings during exposures to H₂ (COMEX, 1984; Adolfson et al., 1985). Kiessling and Maag (1962) demonstrated that performance in VCRT with 2 choices deteriorated (i.e. the time increased) by 21 % in 4 ATA of air. Unfortunately in our study, no measurements were made during the nitrox tests, but the same testing technique (4-choice VCRT) used in another laboratory (Linér et al., 1985) showed a significant time increase of 7.3 % in air at 75 m depth.

It appears therefore that insofar as the cognitive psychometric tests and clinical observations are concerned, the divers experienced " a slight

but controllable" narcosis at 450 m in hydrox.

3 - Narcosis

In experiments with hydrogen exposure of humans published before 1984 no observations of narcosis were made. The reasons were different : Case and Haldane (1941) and Edel (1969, 1972, 1974) made shallow exposures : 10 and 7 ATA respectively. Zetterström was deeper : 160 m (Zetterström, 1948; Bjurstedt and Severin, 1948), but his dives were open sea dives which made detailed observations of narcosis difficult. Furthermore, Zetterström shifted from nitrox at appr 60 m and hydrox breathing to him must therefore have seemed free from narcosis. COMEX (1984) and Adolfson and Ornhagen (1984) reported narcosis during hydrogen exposures. The findings of Adolfson and Ornhagen were only slight because of the relatively low pressure 13 ATA. The COMEX experiments showed at a PH_2 of 24.5 bar such a degree of narcosis that this seemed to be the upper limit for human exposures at the depth of 240 m. In exposures at 300 m ternary mixtures with PH_2 of 23.1 and 19.2 bar were used. Narcosis affects the cognitive processes. This was studied by Behnke et al. (1935) using mental arithmetic problems in simulated air dives. The Paced Auditory Serial Addition Test is not a mental arithmetic test in a conventional sense. The additions are so simple that any subject - irrespective of education - is normally able to solve most of the additions within the given limit of time. However, PASAT also contains a factor of memory. A characteristic quality of the normal consciousness is immediate memory, which makes it possible to coordinate previous acts and experiences with coming actions. A reduction of the number of correct answers on PASAT can be caused by a deteriorated memory alone or in combination with a slowing of the mental activity and a reduced power of concentration. It is noteworthy that a complex task such as Multiplications test could be performed as well in a PH_2 of 26 bar (see first measurement at 450 m) as in heliox at 10 m. This raises the question of concentration and motivation. It is our subjective impression that a fluctuation of concentration and motivation can be the explanation behind the great variations of performance in non-paced tests such as Number Similarities and Multiplications tests where the subject are left alone with the test for a specified time period. In PASAT and reaction time measurements the diver is "alerted" by the test every 2 to 4 sec. For the diver in water however, it is important that he can stay mentally alert although the surroundings are monotonous and do not give "alerts". For the future it is thus important to design tests to measure ability and willpower to concentrate. During the HYDRA IV experiment (COMEX, 1984), the Multiplications test

seems to have been less sensitive to the divers' state of alertness. The variations were smaller and the performances were proportional to the P_{H_2} . This difference is probably due to the different experimental conditions in the two dives. In HYDRA IV the diver was breathing a new gas always after a transfer through water to the dome. This kept him alert and motivated for the tests. The performances on the multiplications tests in hydrox and in air during HYDRA IV enabled us to evaluate the relative narcotic potency for H_2 to 0.21 of nitrogen (Carlioz et al., 1985). We can make the same theoretical calculation for the three narcosis tests used in HYDRA V.

- PASAT : The mean deterioration was 18.5 % at 450 m depth with a mean P_{H_2} of 25.5 bar. Since we were unable to give the PASAT during the nitrox dive to 66 m and during the trimix breathing period at 450 m the experimental conditions and the subjects could not be the same in our calculation. However, the PASAT test showed a deterioration of 29 % at 75 m with a $P_{N_2} = 6.5$ bar (Linér et al., 1985). Our calculations yield a H_2/N_2 narcotic potency ratio of 0.16.
- Multiplications test : the mean deterioration at 450 m was 7.7 % with a P_{H_2} of 25.5 bar, and was 16 % at 66 m with a P_{N_2} of 7.2 bar, giving a H_2/N_2 narcotic potency ratio of 0.14.
- Number Similarities test : there was a decline of 10 % in the performance at 450 m with a P_{H_2} of 25.5 bar and of 16.3 % at 66 m with a P_{N_2} of 7.2 bar, giving a narcotic potency ratio of 0.17.

On the average the ratio is 0.16, which is not very different from the HYDRA IV findings of 0.21, but these results are a little lower than those estimated by Brauer et al. (1982) : 0.25 on the basis of the studies conducted by Brauer and Way (1970) and Kent et al. (1976). On the basis of the H_2/N_2 narcotic potency ratio of 0.16 we estimate the narcosis experienced by the divers in hydrox at 450 m to be equivalent to that felt on air at 45 m. Our subjective observations of narcosis indicate a slightly deeper air equivalent depth. However, as pointed out earlier the narcosis seems to be controllable and therefore it is not possible or advisable to make too vivid interpretations of behavior during divers time off in chambers.

The evolution of narcosis as a function of time is as yet little known. Few saturations have been carried out in a narcotic gaseous atmosphere. However, after 7 days in nitrox at 60 m ($PO_2 = 0.22$ bar) (Hamilton et al., 1982), the narcosis is subjectively still present and test performances are variable. More recently during a nitrox saturation of 6 days at 60 m ($PO_2 = 0.4$ bar) (Muren et al., 1984) it appeared that the narcosis was ameliorated but did not entirely disappear over 5 days. In our study, after two and a half days in hydrox at 450 m the narcosis did not disappear, and we do not possess sufficient results for the 3 divers who remained for more than 4 days in

hydrogen at 25 bar.

4 - HPNS

The VCRT test has often been used during deep dives in heliox and trimix (Bennett, 1981a; 1981b; Bennett and Towse, 1971; Lemaire, 1980; 1982) and normally an increase in the VCRT time is observed upon arrival at the bottom (from +10 to +15 %). This gradually decreases during the period spent on the bottom. The VCRT is probably not specific to the HPNS for it is also sensitive to a strong narcosis (Kiessling and Maag, 1962). In our study, however, the VCRT shows no variation during the entire time in hydrox. Neither narcosis nor HPNS is revealed therefore by this test, in hydrox. On the other hand, for the 3 divers who switched to heliox while at 450 m, we observed a tendency for the VCRT time to increase (+12 %), which may be correlated to the HPNS symptoms which appeared in this gas mix.

5 - Pressure - Narcosis reversal effect

Brauer et al. (1982) have established equations for calculating the level of narcosis caused by a given gas at a given depth (arbitrary scale). For a nitrox 95/5 mixture at 66 m, the level of narcosis calculated is 6.08. For trimix with 16.9 % N₂ at 450 m the level of narcosis calculated is 3.13. This suggests that the level of narcosis felt by the divers during the trimix test should have been about half that they felt during the nitrox dive at 66 m. But this has not been verified neither by the results of our tests (e.g. the Multiplications showed much greater deterioration on trimix at 450 m) nor by the self-observation of the divers, who reported at 450 m a grade of narcosis analogous to an air dive to between 60 and 80 meters. The results of the NS and M tests performed during HYDRA IV at 240 m and HYDRA V at 450 m under about the same P_{H₂} (24.5/25.5 bar), showed great variation and were difficult to interpret. Hence no conclusion regarding any possible pressure reversal can be made.

6 - Experimental errors

a) *Error on the part of the investigator*

This could be a consideration, particularly for the PASAT, because of the problems of unscrambling the voices and communications. To reduce the possibility of error, the investigator first did the scoring on the scoring sheet. The question and answers were taped. The answers were then double checked in the laboratory by listening to the tape without the original answer sheet, and the 2 answers sheets were then compared.

b) *Cheating on the part of the divers*

When repeated tests are performed on men in long time confinement the "sport" of cheating has to be anticipated. The VCRT is impossible to falsify but PASAT, M, and NS could be more or less copied on the best of the divers or the best diver could give help to the other divers. In this dive cheating was found to take place during some of the last tests of the post-dive control series when both divers and investigators were tired and bored by the tests. However, we do not think this had any impact on the results and interpretation.

CONCLUSION

HYDRA V was the first instance where 6 men lived in a hydrogen-helium-oxygen atmosphere at 450 meters depth successfully.

The percentage of hydrogen in the mixture was around 55 % and the P_{H_2} 25.5 bar. Due to the P_{H_2} a slight but controllable narcosis was felt by and observed in all of the subjects in varying degrees. The narcosis was evaluated by means of 3 cognitive tests (Number Similarities, Multiplications, Paced Auditory Serial Addition Test) which showed moderate deterioration in performance and a broad individual variability. On the basis of these tests the narcosis experienced by the divers in hydrox at 450 m could be compared to the narcosis during air dives at 45 m.

The 4-choice VCRT test used in this experiment did not show any significant variation in hydrox, which seems to confirm the absence of HPNS.

REFERENCES

- ADOLFSON J.. Deterioration of mental and motor functions in hyperbaric air. Scand. J. Psychol., 6, 26-31, 1965.
- ADOLFSON J., ÖRNHAGEN H.. Narcosis. In "Hydrogen-Oxygen (hydrox) breathing at 1.3 MPa". FOA report C 58015-H1, 33-43, 1984.
- ADOLFSON J., INGVAR D.H., ÖRNHAGEN H.. Psychophysiological performance during breathing of 1.3 MPa (13 atm) hydrox. Proceedings of Xth EUBS Congress, Marseille, 4-5-6 Oct. 1984, 61-73, 1985.
- BEHNKE A.R., THOMSON R.M., MOTLEY E.P.. The psychologic effects from breathing air at 4 atmospheres pressure. Am. J. Physiol., 112, 554-558, 1935.
- BENNETT P.B.. Rapid compression to 2132 ft without incapacitating HPNS. J. Soc. Underwater Technol., 7 (3), 19-23, 1981a.
- BENNETT P.B.. ATLANTIS III, an experimental deep dive to 686 m using Trimix 10. Med. Aero. Spat., Med. Sub. Hyp., 80, 320-322, 1981b.
- BENNETT P.B., BLENKARN G.D.. Arterial blood gases in man during inert gas narcosis. J. Appl. Physiol., 36 (1), 45-48, 1974.
- BENNETT P.B., TOWSE E.J.. Performance efficiency of men breathing oxygen helium at depth between 100 feet and 1500 feet. Aerospace Med., 42, 1147-1156, 1971.
- BENNETT P.B., COGGIN R., MC LEOD M.. Effect of compression rate on use of trimix to ameliorate HPNS in man to 686 m (2250 feet). Undersea Biomed. Res., 9 (4), 335-351, 1982.
- BJURSTEDT H., SEVERIN G.. The prevention of decompression sickness and nitrogen narcosis by use of H₂ as a substitute for nitrogen. Mil. Surgeon, 103, 107-116, 1948.
- BRAUER R.W., WAY R.. Relative narcotic potencies of hydrogen, helium, nitrogen and their mixtures. J. Appl. Physiol., 29 (1), 23-31, 1970.
- BRAUER R.W., HOGAN P.M., HUGON M., MACDONALD A.G., MILLER K.W.. Patterns of interaction of effects of light metabolically inert gases with those of hydrostatic pressure as such - a review. Undersea Biomed. Res., 9 (4), 353-396, 1982.
- CARLIOZ M., GARDETTE-CHAUFFOUR M.C., ROSTAIN J.C., GARDETTE B.. Hydrogen narcosis : psychometric and neurophysiological study. Proceedings of Xth EUBS Congress, Marseille, 4-5-6 Oct., 1984, 97-109, 1985.

- CASE E.M., HALDANE J.B.S.. Human physiology under high pressure. *J. Hygiene*, 41, 225-249, 1941.
- COMEX. HYDRA IV. Final report (english/français). COMEX, Marseille, France, 1984.
- DRET. ENTEX 5 : expérience de plongée profonde à 450 m avec 12 jours de séjour au fond. Rapport final contrat DRET/MARINE NATIONALE 80/1247, Broussolle B. ed., Toulon-Naval, France, 1982.
- DRET. ENTEX 8 : expérience de plongée fictive profonde à 46 ATA (450 m) avec 12 jours de séjour au fond et travail en position immergée. Rapport final, contrat DRET/MARINE NATIONALE 81/1281, Broussolle B. ed., Toulon-Naval, France, 1984.
- DRET. ENTEX 9 : expérience de plongée fictive à 46 ATA (450 m) avec 6 jours de séjour à cette pression, puis 62 ATA (610 m), 56 heures, après arrêts à 520 et 570 m (mélange binaire hélium-oxygène). Rapport final contrat DRET/MARINE NATIONALE 83/1065, Broussolle B. ed., Toulon-Naval, France, 1984.
- EDEL P.O..TEKTITE I to test merits of nitrogen-oxygen breathing mix. *Ocean Ind.*, 4, 61-65, 1969.
- EDEL P.O..Mixing hydrogen safely. *Oceanol. Int.*, 7, 31-33, 1972.
- EDEL P.O.. Report on project Hydrox II. CNR report contract n° N00014-73-C-0233, 1974.
- FROBERG J.E.. Psychophysiological circadian rhythms : a literature review. FOA reports. National Defence Research Institute, Stockholm, 9 (6), 1-27, 1975.
- FRUCTUS X., GARDETTE B., CARLIOZ M., GIRAN Y.. Hydrogen narcosis. Proceedings of Xth EUBS Congress, Marseille, 4-5-6 Oct. 1984, 87-96, 1985.
- GENNSER M., ÖRNHAGEN H.. Effects of hydrogen and hydrostatic pressure on isolated heart preparations. Workshop of Wilmington, North Carolina, 3-4-5 Oct. 1985.
- GRONWALL D.. Paced Auditory Serial Addition Task : a measure of recovery from concussion. *Percept. Motor Skills*, 44, 367-373, 1977.
- GRONWALL D., WRIGHTSON P.. Delayed recovery of intellectual function after minor head injury. *The Lancet*, Sept. 14, 605-609, 1974.

HAMILTON R.W., ADAMS G.M., HARVEY C.A., KNIGHT D.R.. SHAD-NISAT : a composite study of shallow saturation diving. NSMRL report n° 985, Groton, Conn., 1982.

KENT D.W., HALSEY M.J., EGER II. Pharmacological effects of helium, neon, hydrogen and nitrous oxide. In Underwater Physiology V, Lambertsen C.J. ed., FASEB, Bethesda, Md, 1976.

KIESSLING R.J., MAAG C.H.. Performance impairment as a function of nitrogen narcosis. J. Appl. Physiol., 46, 91-95, 1962.

LEMAIRE C.. Differential performance behavior after 40 hours compression to 450 msw. In abstracts of VIIth symposium on Underwater Physiology, Athenes, 21, 1980.

LEMAIRE C.. Performances psychométriques. Rapport final contrat DRET/MARINE NATIONALE 80/1247, chap. VI, 1-28, 1982.

LINER M.H., EIKEN O., GENNSER M., ROCKERT H., ÖRNHAGEN H.. An attempt to counteract nitrogen narcosis by naloxone administration. Proceedings of the XIth EUBS Congress, Goteborg, Aug. 21-23, 99-104, 1985

MILLER K.W.. The opposing physiological effects of high pressures and inert gases. Fed. Proc., 36 (5), 1663-1667, 1977.

MUREN A., ADOLFSON J., ÖRNHAGEN H., GENNSER M., HAMILTON R.W.. NISAHEX : deep nitrox saturation with nitrox and trimix excursions. Proceedings of Underwater Physiology VIII, Bachrach A.J. and Matzen M.M. eds, UMS, Bethesda, Md 713-729, 1984.

ÖRNHAGEN H.. Influence of nitrous oxide, nitrogen, neon and helium on the beating frequency of the mouse sinus node at high pressure. Undersea Biomed. Res., 6 (1), 27-40, 1979.

ÖRNHAGEN H.. Hydrogen-Oxygen (hydrox) breathing at 1.3 MPa. FOA report C 58015-H1, Swedish Defence Research Institute, 1984.

ROSTAIN J.C., GARDETTE B., GARDETTE-CHAUFFOUR M.C., NAQUET R.. HPNS in human during 38 hours compression to 450 m with N2 injections. In abstracts of VIIth symposium on Underwater Physiology, Athenes, 16, 1980.

SHILLING C.W. WILLGRUBE W.W.. Quantitative study of mental and neuromuscular reactions as influenced by increased air pressure. US Nav. Med. Bull., 35, 373-380, 1937.

SMITH N.E.. Effect of substituting hydrogen for helium on human thermal exchange in hyperbaric environments. Ocean. Res. Eng. Cent. final report contract N° N0014-72-C-0545, 1974.

ZETTERSTROM A.. Deep sea diving with synthetic gas mixtures. Mil. Surgeon,
103, 104-106, 1948..

THIS DOCUMENT IS THE PROPERTY OF COMEX, all information contained herein may neither be reproduced, used, disclosed, transmitted nor in any way made public without the written permission of the owner. any person in possession of this document acknowledges being bound by the obligation to treat it as confidential.

« THIS DOCUMENT IS THE PROPERTY OF COMEX, all information contained herein may neither be reproduced, used, disclosed, transmitted nor in any way made public without the written permission of the owner, any person in possession of this document acknowledges being bound by the obligation to treat it as confidential».

A P P E N D I X

INDIVIDUAL RESULTS TO THE 4 PSYCHOMETRIC TESTS :

NUMBER SIMILARITIES

MULTIPLICATIONS

PACED AUDITORY SERIAL ADDITIONS TEST

VISUAL CHOICE REACTION TIME

- Individual performances
- Individual percentages of variation
- Individual curves

« THIS DOCUMENT IS THE PROPERTY OF COMEX, all information contained herein may neither be reproduced, used, disclosed, transmitted nor in any way made public without the written permission of the owner. any person in possession of this document acknowledges being bound by the obligation to treat it as confidential. »

Depth (m)	0	0	0	0	0	0	0	0	66	15	10	10	142	245	400	450	450	450	450	450	455	450	450	450	450	420	78/79	52/61	42/53	20/33	12/8,5		
Gas	air	air	air	air	air	air	air	air	niob	air	He	He	He	H2	H2	H2	H2	H2	H2	He	He	He	He	He	He	He	He	He	He	He	He	He	
PH ₂ (bar)									rox chamber					5	20	25	25	25	25	13						19	19	19	19	19	19	19	19
A1	n	129	146	147	162	153	161	167	161	136	194	161	188	170	167	130	146	123	149	153	170	176	174	176	150	140	180	184	214	209	183		
	e	0	1	2	1	1	1	1	3	3	2	1	0	4	2	1	1	1	1	2	4	0	0	1	4	3	0	1	2	1	4		
A2	n	81	93	101	98	101	98	92	120	97	92	107	101	110	111	111	93	82	109	98	97	90	101	129	89	107	124	129	161	117	144		
	e	1	1	0	0	0	0	0	0	2	0	0	0	0	0	1	0	0	0	0	0	0	2	2	0	0	0	0	0	0	0		
A3	n	124	140	146	154	157	168	174	168	136	155	168	131	144	150	136	146	130	149	140	144	142	149	140	168	124	155	176	144	156	161		
	e	0	1	0	0	0	1	1	1	1	3	1	0	0	1	1	0	0	0	0	0	1	2	1	0	1	1	0	0	1	0		
B1	n	133	124	163	162	161	150	137	168	130	174	161	167	161	176	153	149	117	136							153	203	174	161	170	167		
	e	1	0	0	3	0	0	0	1	1	0	0	0	0	0	0	0	2	0							3	1	1	0	0	2		
B2	n	116	126	131	142	131	135	137	146	118	124	140	124	136	156	140	131	123	118							161	176	167	144	156	150		
	e	3	1	3	3	1	2	3	3	1	1	0	1	1	0	0	0	0	0							1	0	2	0	0	2		
B3	n	109	133	131	137	148	135	131	153	150	144	146	131	144	150	135	137	130	144							146	161	155	161	156	162		
	e	2	0	0	1	3	0	0	3	4	1	2	0	1	1	1	0	0	0							0	1	0	0	1	2		
	n	115	127	137	143	142	141	140	153	128	147	147	140	146	152	134	134	118	134	130	137	136	141	148	136	124	153	167	164	164	161	162	
	+ Sd	17	17	19	22	21	23	27	17	17	33	20	29	17	20	13	19	17	15	23	30	35	30	20	34	13	6	24	18	24	27	12	
	e	1.2	0.7	0.8	1.3	0.8	0.7	0.8	1.8	2.3	0.8	0.50	0.2	1.2	0.7	0.5	0.2	0.5	0.2	0.7	1.7	0.7	1.0	1.0	1.7	1.3	1.3	0.3	0.7	0.3	0.5	1.7	
	+ Sd	1.1	0.5	1.2	1.2	1.1	0.7	1.1	1.2	1.1	0.7	0.80	0.4	1.3	0.7	0.5	0.4	0.7	0.4	0.9	1.7	0.9	0.8	0.8	1.7	1.2	1.2	0.5	0.7	0.7	0.5	1.4	

Individual performances on the Number Similarities test of the 6 divers during HYDRA V expressed in number of figures examined in 1 minute (n) and number of errors (e). Means (\bar{n} , \bar{e}) \pm Sd were calculated.

Depth (m)	66	142	245	400	450	450	450	450	450	450	450	450	450	420	End of decompression					
PH ₂ (bar)	0	0	5	20	25	25	25	25	13	0	0	0	0	19	0	0	0	0	0	
PN ₂ (bar)	7.2	0	0	0	0	0	0	0	0	0	0	0	0	7.8	0	0	0	0	0	
A1	-16	-3	-4	-26	-16	-30	-15	-13	-3	+1	-1	+1	-7		+3	+5	+22	+19	+5	
A2	-19	+14	+7	+7	-11	-21	+5	-6	-7	-14	-3	+24	+20		+19	+24	+55	+13	+39	
A3	-19	-4	+0	-9	-2	-13	-0	-7	-4	-5	-1	+7	-26		+3	+17	-4	+4	+7	
B1	-23	-2	+7	-7	-9	-29	-17								-7	+24	+6	-1	+4	+2
B2	-19	+3	+18	+6	-1	-7	-11								+22	+33	+27	+9	+18	+14
B3	-2	+4	+8	-3	-1	-6	+4								+5	+16	+12	+16	+12	+17
\bar{x}	-16	+2	+6	-5	-7	-18	-6	-8	-5	-6	-1	+6	-4	+7	+16	+15	+16	+12	+14	
\pm Sd	7	6	7	11	6	10	9	3	2	6	1	13	19	12	11	8	20	6	12	

Individual variation of the performance on the Number Similarities test in percentage (%) relative to the reference value (average of 2 tests at 10 m on heliox, except for the tests at 66 m and at 450 m under N₂ where the references were the preceding test). Mean of variation (\bar{x}) \pm Sd was calculated.

« THIS DOCUMENT IS THE PROPERTY OF COMEX, all information contained herein may neither be reproduced, used, disclosed, transmitted nor in any way made public without the written permission of the owner, any person in possession of this document acknowledges being bound by the obligation to treat it as confidential ».

Depth (m)	0	0	0	0	0	0	0	0	66	15	10	10	142	245	400	450	450	450	450	450	455	450	450	450	450	420	78/79	52/61	42/53	20/33	12/8,5	
Gas	air	air	air	air	air	air	air	air	rox	air	He	He	He	H2	H2	H2	H2	H2	H2	He	He	He	He	He	He	He	He	He	He	He	He	He
PH ₂ (bar)									chamber					5	20	25	25	25	25	13												
A1	m	14	16	13	15	17	16	14	15	13	18	15	15	19	20	14	19	14	17	14	18	16	15	17	16	14		16	18	16	17	14
	e	5	10	5	5	3	7	4	5	10	6	4	6	3	8	9	10	6	4	2	9	4	5	6	6	4		4	2	5	2	3
A2	m	25	24	26	24	30	28	27	28	21	28	28	27	32	27	21	22	18	19	15	25	25	25	23	21	15		27	29	29	26	27
	e	2	1	1	1	1	3	0	4	2	1	4	0	1	2	4	3	3	1	6	2	4	4	0	2	3		2	3	4	1	4
A3	m	31	34	35	28	39	38	39	33	24	35	32	31	34	35	29	30	29	32	33	38	38	37	38	37	22		38	39	38	37	36
	e	5	1	1	2	4	3	2	2	4	2	2	0	2	2	1	1	2	3	2	3	5	2	5	0	5		2	1	4	1	1
B1	m	16	21	21	22	21	25	23	22	17	26	22	21	25	27	16	23	16	12								18	26	23	25	25	29
	e	5	0	0	2	1	1	4	2	4	1	3	4	4	1	3	2	3	2								4	2	0	0	1	3
B2	m	19	22	22	23	23	22	23	22	22	22	19	25	23	25	17	20	21									23	27	24	24	25	29
	e	3	0	1	5	3	2	3	4	6	0	1	1	2	1	4	4	2	1								7	1	2	1	0	4
B3	m	24	30	30	33	35	27	30	28	27	31	30	33	36	35	25	37	29	30								26	31	29	29	32	30
	e	0	1	2	3	4	0	0	0	4	2	2	2	3	3	3	3	7	4								2	1	4	3	2	4
	m	22	25	25	24	28	26	26	25	21	27	25	24	29	28	22	25	21	22	21	27	26	26	26	25	17	22	28	27	27	28	
	e	6	6	7	6	8	7	8	6	5	6	6	7	6	6	5	7	6	7	9	8	9	9	9	9	4	3	7	7	7	6	7
	m	3.3	2.2	1.2	3.0	2.7	2.7	2.2	2.8	5.0	2.0	2.7	2.2	2.5	2.8	4.0	3.8	3.8	2.5	3.3	4.7	4.3	3.7	3.7	2.7	4.0	4.3	2.0	2.0	2.8	1.2	3.2
	e	1.9	3.5	1.6	1.5	1.2	2.2	1.7	1.7	2.5	1.9	1.1	2.2	1.0	2.4	2.4	2.9	2.0	1.3	1.9	3.1	0.5	1.2	2.6	2.5	0.8	2.1	1.0	1.3	1.8	0.7	1.1

Individual performances on the Multiplications test of the 6 divers during HYDRA V expressed in number of multiplications solved in 2 minutes (m) and number of errors (e). Means (\bar{m} , \bar{e}) \pm Sd were calculated.

Depth (m)	66	142	245	400	450	450	450	450	450	450	450	450	450	450	420	End of	decompression			
PH2 (bar)	0	0	5	20	25	25	25	25	13	0	0	0	0	0	19	0	0			
PN2 (bar)	7.2	0	0	0	0	0	0	0	0	0	0	0	0	7.8	0	0	0			
A1	-13	+27	+33	-7	+27	-7	+13	-7	+20	+7	0	+13	-13		+7	+20	+7	+13	-7	
A2	-25	+16	-2	-24	-20	-35	-31	-46	-9	-9	-9	-16	-29		-0	+6	+6	-6	-0	
A3	-27	+8	+11	-8	-5	-8	+2	+5	+21	+21	+18	+21	-41		+21	+24	+21	+18	+14	
B1	-23	+16	+26	-26	+7	-26	-44								-16	+21	+7	+16	+16	+35
B2	-4	+22	+12	+22	-17	-2	+2								+12	+32	+17	+17	+22	+42
B3	-4	+14	+11	-21	+18	-8	-5								-18	-2	-8	-8	+2	-5
\bar{x}	-16	+17	+15	-10	+2	-14	-10	-16	+11	+6	+3	+6	-27		-7	+13	+11	+10	+11	+13
\pm Sd	10	6	11	16	17	12	20	22	5	12	11	16	12	14	12	11	10	10	19	

Individual variation of the performance on the Multiplications test in percentage (%) relative to the reference value (average of 2 tests at 10 m on heliox, except for the 2 tests at 66 m and at 450 m under N₂ where the references were the preceding test). Mean of variation (\bar{x}) \pm Sd was calculated.

« THIS DOCUMENT IS THE PROPERTY OF COMEX, all information contained herein may neither be reproduced, used, disclosed, transmitted nor in any way made public without the written permission of the owner, any person in possession of this document acknowledges being bound by the obligation to treat it as confidential. »

Depth (m)	Gas PH ₂ (bar)	0	0	0	0	0	0	0	0	0	10	10	142	245	400	450	450	450	450	455	450	420	78/79	52/61	42/53	20/33	12/8.5	
		air	air	air	air	air	air	air	air	air	He	He	He	H ₂ 5	H ₂ 20	H ₂ 25	H ₂ 25	H ₂ 25	H ₂ 25	He	He	H ₂ 19	He	He	He	He	He	
A1	c	18	29	30	37	38	40	36	41	45	40	38	48	45	42	34	33	43	37	44	41	40		38	36	44	46	48
	e	46	35	35	27	30	25	22	20	14	18	19	13	10	13	19	13	8	4	3	9	8		19	24	13	9	11
A2	c	5	5	4	5	1	4	11	8	10	11	12	8	14	14	16	23	18	28	22	19	21		12	9	12	14	10
	e	65	67	61	69	65	59	66	64	64	67	67	66	68	68	63	51	65	56	65	67	65		66	67	69	63	69
A3	c	4	1	7	0	4	10	2	1	0	1	0	1	0	0	2	0	0	3	2	0	0		2	1	0	2	0
	e	0	1	1	0	0	0	0	1	4	5	1	2	2	1	1	4	18	4	10	2	2	4		1	1	0	4
B1	c	60	68	67	69	68	69	69	69	69	68	68	67	69	69	66	68	68	65	68	63	69		68	69	65	68	69
	e	6	0	1	0	0	0	0	0	0	0	0	0	0	0	1	0	0	1	1	3	0		0	0	3	1	0
B2	c	3	1	1	0	1	0	0	0	0	0	1	2	0	0	2	1	1	3	0	3	0		1	0	1	0	0
	e	47	55	56	58	57	60	58	61	59	62	65	64	66	63	47	38	44	36				48	68	69	67	66	66
B3	c	17	11	11	6	8	6	10	5	8	6	3	2	1	4	16	25	17	30				14	1	0	2	2	3
	e	5	3	2	5	4	3	1	3	2	1	1	3	2	2	6	6	8	3				7	0	0	0	1	0
B2	c	30	39	52	36	37	41	46	57	56	53	52	61	55	51	43	42	42	33				51	62	65	65	62	60
	e	30	26	15	32	26	24	20	11	13	13	12	8	14	11	25	25	24	34				14	5	4	3	6	8
B3	c	9	4	2	1	6	4	3	1	0	3	5	0	0	0	7	1	2	3	2			4	2	0	1	1	1
	e	51	64	68	69	69	69	69	68	63	69	68	68	65	64	53	53	58	64				62	68	69	68	68	68
Σ	c	12	3	0	0	0	0	0	0	0	0	0	0	0	0	11	4	6	0				2	0	0	0	1	0
	e	6	2	1	0	0	0	0	1	4	0	1	1	4	5	5	12	5	5				5	1	0	1	0	1
+ Sd	c	45	54	56	56	56	56	57	60	59	60	60	62	61	60	51	48	53	49	59	57	58	54	62	63	63	62	63
	e	16	15	13	15	13	12	13	9	8	10	11	7	9	10	11	12	11	14	11	11	13	6	11	12	9	8	8
- Sd	c	20	13	12	11	11	11	9	6	6	6	6	4	4	5	12	11	9	12	2	4	3	10	5	5	4	4	4
	e	15	13	12	13	12	10	9	7	6	7	7	5	6	5	9	11	9	14	1	4	4	6	7	9	4	3	4
- Sd	c	5	3	2	2	2	2	3	3	4	3	4	3	4	5	6	10	7	9	8	8	8	5	3	2	3	3	2
	e	3	2	1	2	2	2	4	3	4	4	4	3	5	5	8	6	9	10	8	9	1	4	3	4	5	4	

Individual performances on the Paced Auditory Serial Addition Test of the 6 divers during HYDRA V expressed in number of correct additions (c), number of omissions (o), and number of errors (e). Means (\bar{c} , \bar{o} , and \bar{e}) \pm Sd were calculated.

Depth (m)	142	245	400	450	450	450	450	450	420	End of decompression						
PH ₂ (bar)	0	5	20	25	25	25	13	0	0	19	0	0	0	0		
A1	+5	-2	-21	-23	0	-14	+2	-5	-7		-12	-16	+2	+7	+12	
A2	+2	+2	-5	-23	-2	-16	-2	+1	-2		-1	+1	+4	-5	+4	
A3	+2	+2	-2	+1	+1	-4	+1	-7	+2		+1	+2	-4	+1	+2	
B1	+2	-2	-27	-41	-32	-44					-26	+5	+7	+4	+2	+2
B2	-3	-10	-24	-26	-26	-42					-10	+10	+15	+15	+10	+6
B3	-4	-6	-22	-22	-15	-6					-9	0	+2	0	0	0
\bar{x}	+1	-3	-17	-23	-12	-21	+0	-4	-2	-15	+1	+2	+4	+2	+4	
\pm Sd	3	4	10	12	13	16	2	3	4	8	7	9	6	5	4	

Individual variation of the performance on the Paced Auditory Serial Addition Test (correct additions), in percentage (%) relative to the reference value (average of 2 tests at 10 m on heliox). Mean of variation (\bar{x}) \pm Sd was calculated.

« THIS DOCUMENT IS THE PROPERTY OF COMEX, all information contained herein may neither be reproduced, used, disclosed, transmitted nor in any way made public without the written permission of the owner, any person in possession of this document acknowledges being bound by the obligation to treat it as confidential ».

Depth (m)	Gas	PH ₂ (bar)	0	0	0	0	0	0	0	0	0	10	10	142	245	400	450	450	450	450	455	450	420	78/79	52/61	42/53	20/33	12/8.5	
			air	air	air	air	air	air	air	air	air	He	He	He	He	H ₂	H ₂	H ₂	H ₂	H ₂	H ₂	He	He	He	H ₂	He	He	He	He
A1	t		335	325	315	326	321	315	307	303	322	286	286	307	311	358	302	312	292	285	297	304	344	263	264	273	291	283	
	sd		58	61	58	77	120	17	106	51	83	48	60	76	68	83	46	39	46	40	99	47	105	29	41	46	107	56	
	e		2	2	0	2	0	2	0	1	0	0	2	2	3	2	3	0	1	4	2	2	1	2	2	1	2	1	
A2	t		315	304	309	294	276	271	275	275	285	295	284	290	293	297	307	300	288	285	288	309	328	274	279	288	300	274	
	sd		156	123	134	49	26	35	31	55	62	81	57	56	53	141	138	29	49	69	54	72	113	39	85	77	71	26	
	e		3	0	1	1	1	1	1	3	0	1	1	1	4	4	1	6	1	3	2	2	3	1	2	1	2	3	
A3	t		317	322	317	304	297	312	284	284	289	285	298	307	325	329	326	307	324	300	319	331	322	301	288	308	301	288	
	sd		54	46	51	43	34	39	33	27	37	54	34	40	44	63	46	114	45	65	68	50	52	32	28	79	58	24	
	e		8	4	3	4	2	3	6	6	9	7	5	9	5	3	4	5	7	4	2	6	3	4	5	1	2	1	
B1	t		507	358	353	361	334	344	318	309	305	324	317	321	313	310	324	320	312	306	296	298	311	314	298	292			
	sd		56	40	64	202	76	57	51	36	26	33	41	53	53	30	84	28	27	26	30	43	70	79	57	55			
	e		0	0	0	0	0	0	0	0	1	0	0	0	0	0	2	1	0	1	1	0	0	0	1	0			
B2	t		361	352	350	387	369	364	344	340	328	334	342	336	329	324	335	338	339	347	330	368	326	325	293	302			
	sd		70	54	54	63	59	69	54	67	59	50	54	59	73	41	58	67	59	55	54	129	63	87	45	47			
	e		0	1	0	1	3	1	0	0	0	0	1	0	0	0	0	0	0	0	2	2	0	0	1	0			
B3	t		393	379	363	364	330	332	343	326	313	324	335	329	342	328	337	312	350	311	304	311	306	319	329	337			
	sd		52	48	45	47	37	36	64	37	35	42	48	35	52	39	45	31	57	47	33	33	31	46	90	118			
	e		2	0	0	0	0	0	0	0	2	0	1	0	2	1	3	3	3	3	2	1	0	1	2	0			
	\bar{t}		371	340	335	339	321	323	312	306	307	308	310	315	319	324	322	315	318	306	301	315	331	310	303	296	305	302	296
	\pm sd		66	25	21	34	29	29	26	22	16	20	23	15	15	19	13	12	23	21	13	12	9	15	34	21	18	13	20
	\bar{e}		2.5	1.2	0.7	1.3	1.0	1.2	1.2	1.7	2.0	1.3	1.7	2.0	2.3	1.7	2.2	2.5	2.0	2.5	2.0	3.3	2.3	1.7	1.7	1.5	0.7	1.7	0.8
	\pm sd		2.7	1.5	1.1	1.4	1.2	1.1	2.2	2.2	3.2	2.6	1.6	3.2	1.9	1.5	1.3	2.4	2.7	1.5	0.0	1.9	0.9	0.5	1.2	1.8	0.5	0.5	1.1

Individual performances on the Visual Choice Reaction Time test of the 6 divers during HYDRA V expressed in average time (thousandths of seconds) \bar{t} \pm Sd on 80 light stimulations (t) and number of errors (e). Means (\bar{t} , \bar{e}) \pm Sd were calculated.

Depth (m)	142	245	400	450	450	450	450	450	420	End of decompression					
PH ₂ (bar)	0	5	20	25	25	25	13	0	0	19	0	0	0	0	0
A1	-5	-21	-2	-5	+2	+4	-0	-3	-16	+11	+11	+8	+2	+1	
A2	-2	-4	-7	-5	-0	+1	-0	-8	-14	+5	+3	-0	-5	+5	
A3	-7	-9	-8	-2	-7	+1	-6	-9	-6	+1	+5	-2	+1	+5	
B1	+2	+3	-2	-0	+2	+4				+7	+7	+3	+2	+7	+9
B2	+3	+4	+1	+0	0	-2				+3	-9	+4	+4	+14	+11
B3	-3	+1	-2	+6	-5	+6				+8	+6	+8	+4	+1	-2
\bar{x}	-2	-4	-3	-1	-2	+2	-2	-7	-12	+6	+3	+6	+3	+3	+5
\pm Sd	4	9	3	4	4	3	3	3	4	3	6	3	3	6	4

Individual variation of the performance on the Visual Choice Reaction Time test in percentage (%) relative to the reference value (average of 2 tests at 10 m on heliox). Mean of variation (\bar{x}) \pm Sd was calculated.

« THIS DOCUMENT IS THE PROPERTY OF COMEX, all information contained herein may neither be reproduced, used, disclosed, transmitted nor in any way made public without the written permission of the owner, any person in possession of this document acknowledges being bound by the obligation to treat it as confidential. »

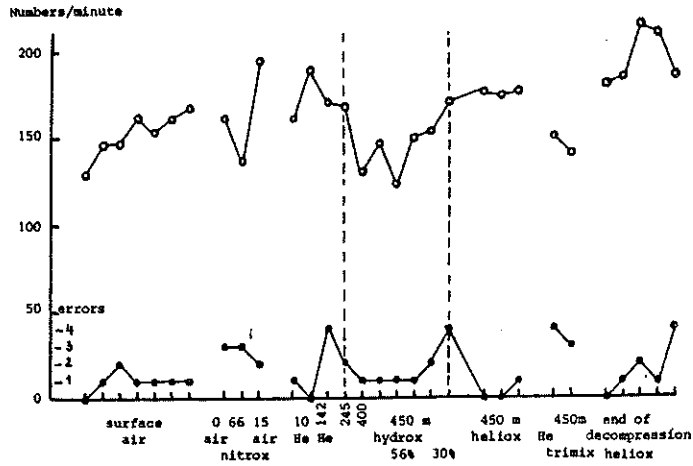

Individual performance on the Number Similarities test of the diver A1 during Hydra V expressed in number of figures examined in 1 minute and number of errors.

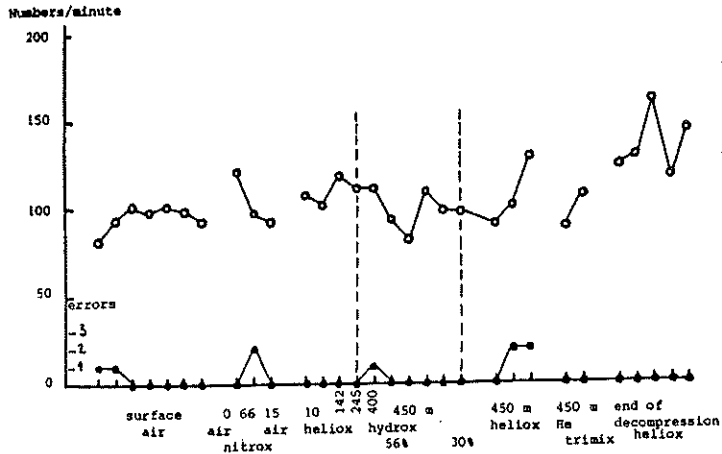

Individual performance on the Number Similarities test of the diver A2 during Hydra V expressed in number of figures examined in 1 minute and number of errors.

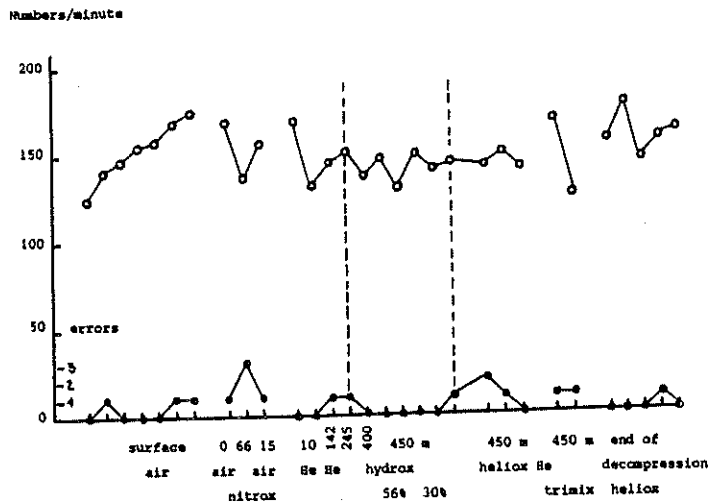

Individual performance on the Number Similarities test of the diver A3 during Hydra V expressed in number of figures examined in 1 minute and number of errors.

« THIS DOCUMENT IS THE PROPERTY OF COMEX, all information contained herein may neither be reproduced, used, disclosed, transmitted nor in any way made public without the written permission of the owner, any person in possession of this document acknowledges being bound by the obligation to treat it as confidential. »

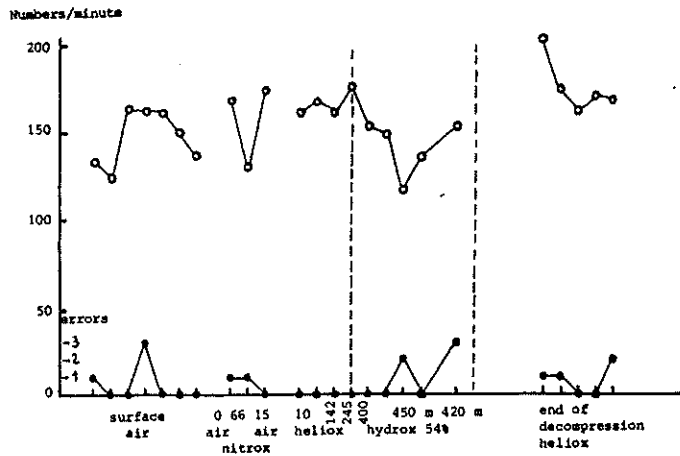

Individual performance on the Number Similarities test of the diver B1 during Hydra V expressed in number of figures examined in 1 minute and number of errors.

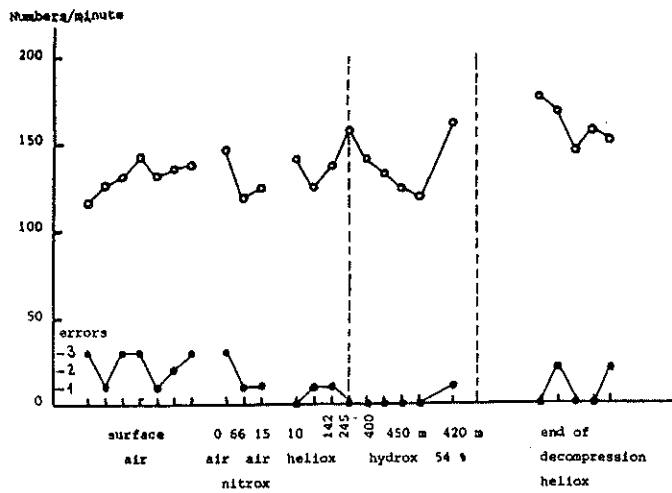

Individual performance on the Number Similarities test of the diver B2 during Hydra V expressed in number of figures examined in 1 minute and number of errors.

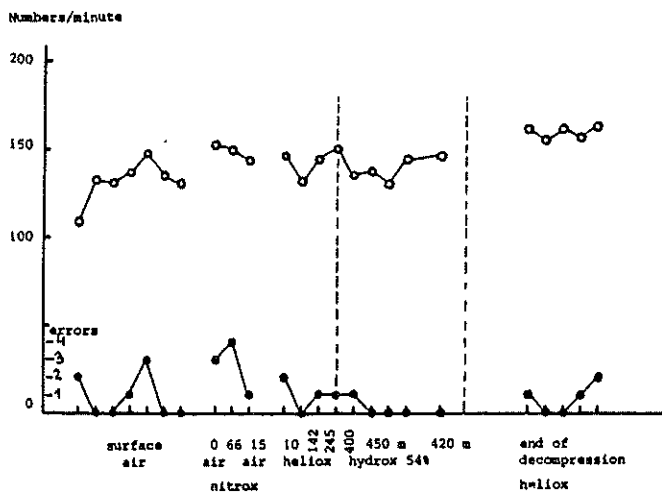

Individual performance on the Number Similarities Test of the diver B3 during Hydra V expressed in number of figures examined in 1 minute and number of errors.

« THIS DOCUMENT IS THE PROPERTY OF COMEX, all information contained herein may neither be reproduced, used, disclosed, transmitted nor in any way made public without the written permission of the owner. any person in possession of this document acknowledges being bound by the obligation to treat it as confidential».

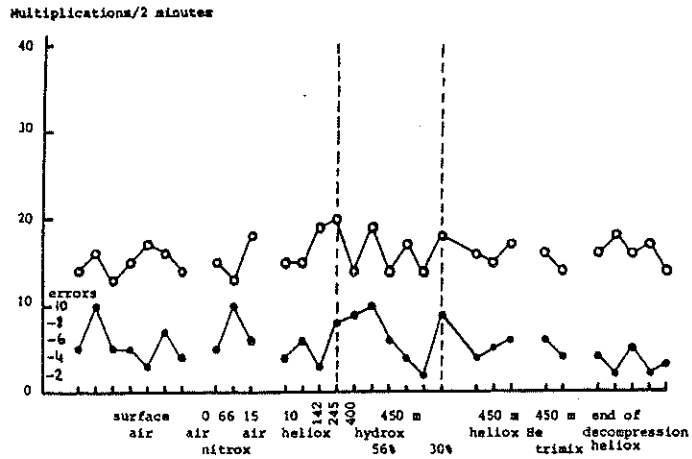

Individual performance on the Multiplications test of the diver A1 during Hydra V expressed in number of multiplications solved in 2 minutes and number of errors.

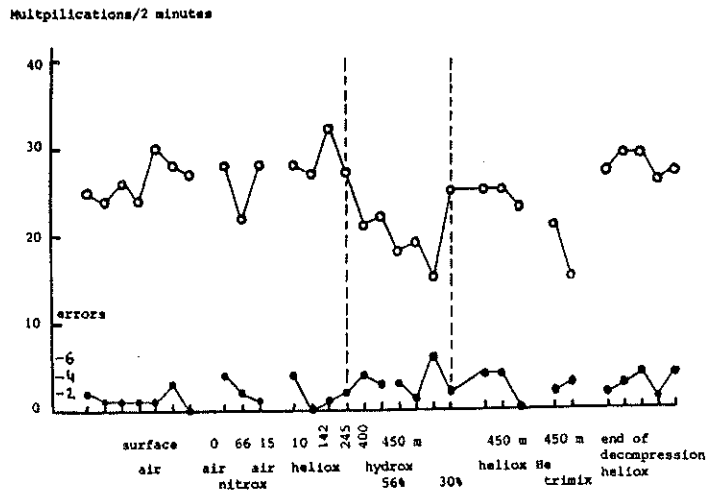

Individual performance on the Multiplications test of the diver A2 during Hydra V expressed in number of multiplications solved in 2 minutes and number of errors.

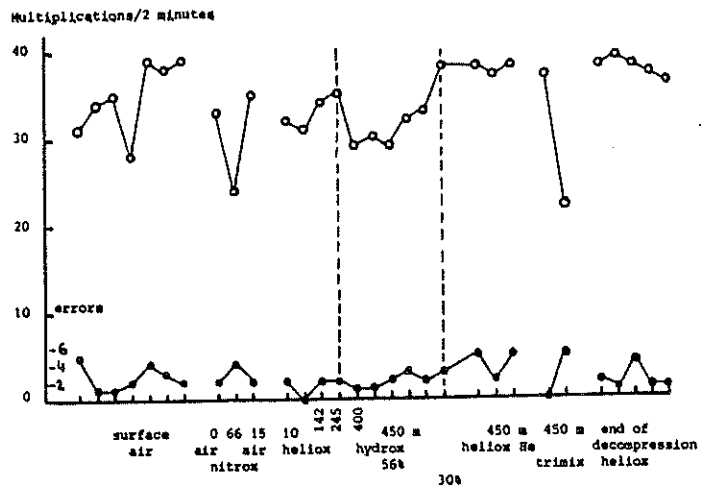

Individual performance on the Multiplications test of the diver A3 during Hydra V expressed in number of multiplications solved in 2 minutes and number of errors.

« THIS DOCUMENT IS THE PROPERTY OF COMEX, all information contained herein may neither be reproduced, used, disclosed, transmitted nor in any way made public without the written permission of the owner, any person in possession of this document acknowledges being bound by the obligation to treat it as confidential. »

Multiplications/2 minutes

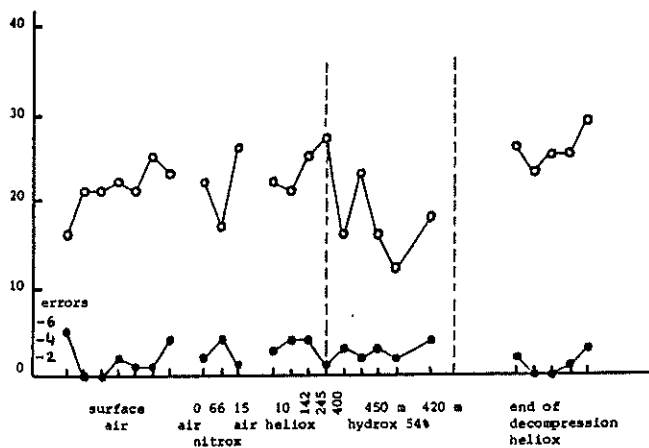

Individual performance on the Multiplications test of the diver B1 during Hydra V expressed in number of multiplications solved in 2 minutes and number of errors.

Multiplication/2 minutes

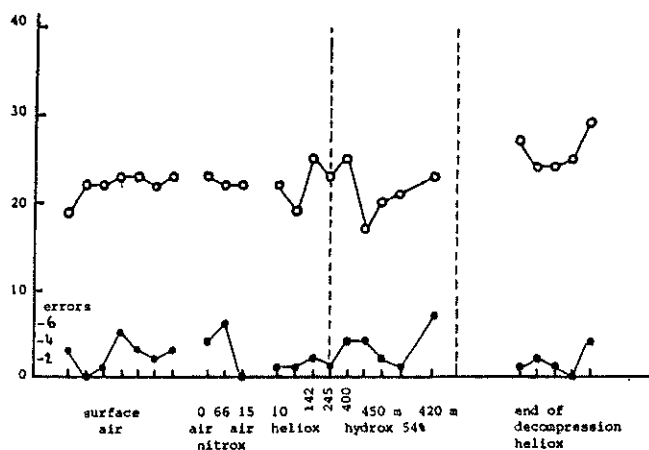

Individual performance on the Multiplications test of the diver B2 during Hydra V expressed in number of multiplications solved in 2 minutes and number of errors.

Multiplications/2 minutes

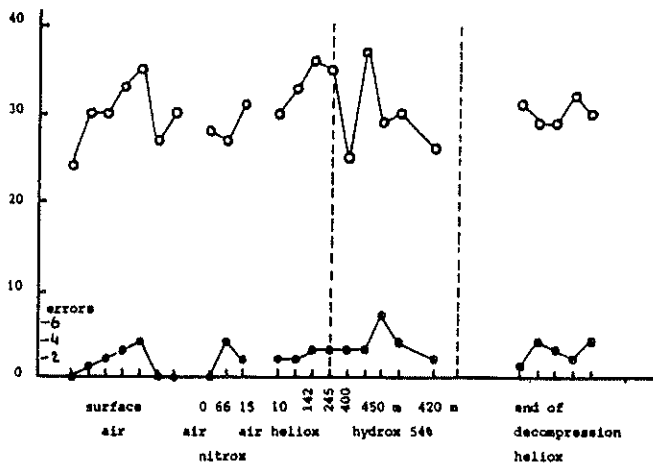

Individual performance on the Multiplications tests of the diver B3 during Hydra V expressed in number of multiplications solved in 2 minutes and number of errors.

« THIS DOCUMENT IS THE PROPERTY OF COMEX, all information contained herein may neither be reproduced, used, disclosed, transmitted nor in any way made public without the written permission of the owner, any person in possession of this document acknowledges being bound by the obligation to treat it as confidential. »

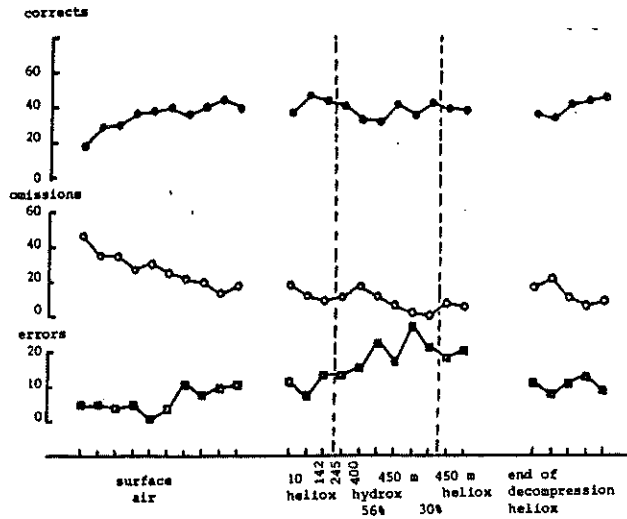

Individual performance on the Paced Auditory Serial Addition Test of the diver A1 during Hydra V expressed in number of correct additions, number of omissions and number of errors.

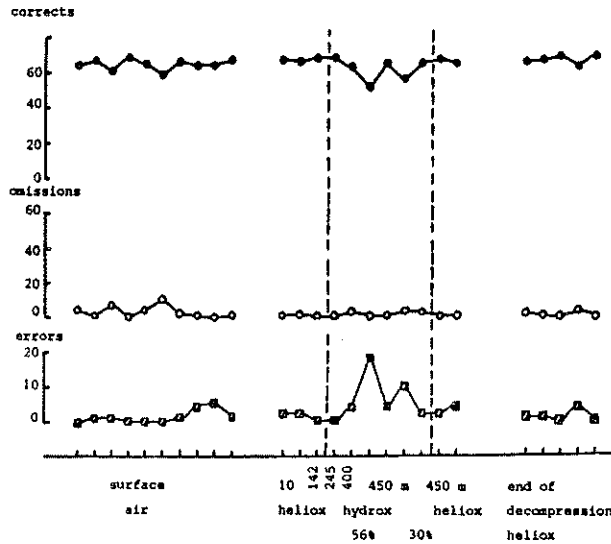

Individual performance on the Paced Auditory Serial Addition Test of the diver A2 during Hydra V expressed in number of correct additions, number of omissions and number of errors.

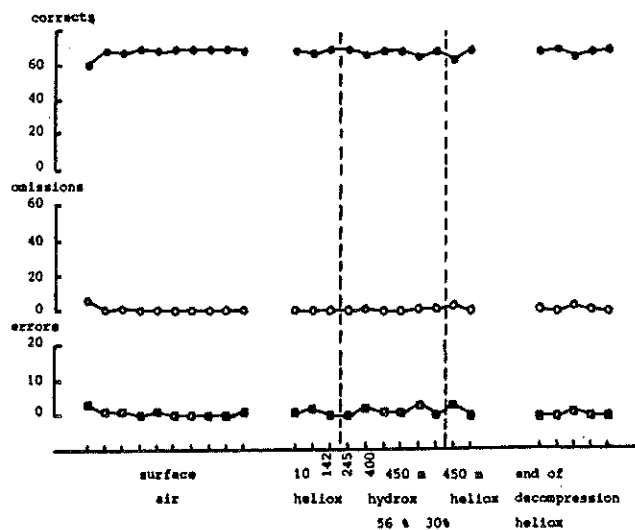

Individual performance on the Paced Auditory Serial Addition Test of the diver A3 during Hydra V expressed in number of correct additions, number of omissions and number of errors.

« THIS DOCUMENT IS THE PROPERTY OF COMEX. all information contained herein may neither be reproduced, used, disclosed, transmitted nor in any way made public without the written permission of the owner. any person in possession of this document acknowledges being bound by the obligation to treat it as confidential. »

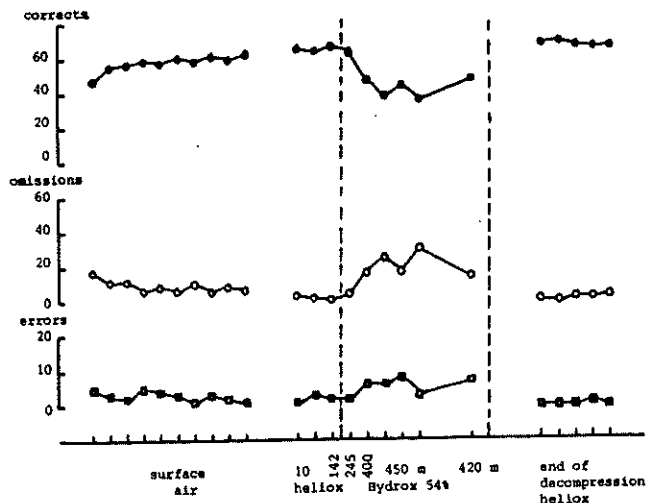

Individual performance on the Paced Auditory Serial Addition Test of the diver B1 during Hydra V expressed in number of correct additions, number of omissions and number of errors.

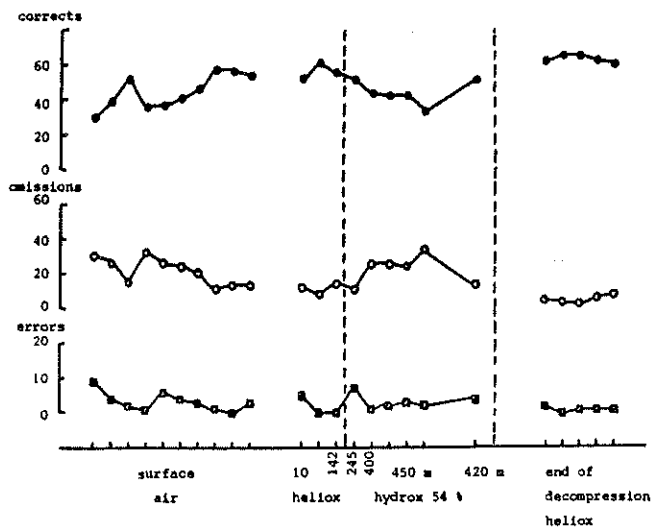

Individual performance on the Paced Auditory Serial Addition Test of the diver B2 during Hydra V expressed in number of correct additions, number of omissions and number of errors.

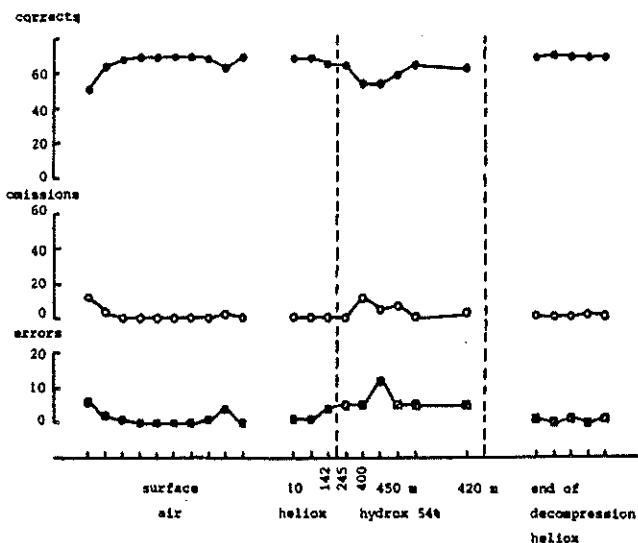

Individual performance on the Paced Auditory Serial Addition Test of the diver B3 during Hydra V expressed in number of correct additions, number of omissions and number of errors.

« THIS DOCUMENT IS THE PROPERTY OF COMEX. all information contained herein may neither be reproduced, used, disclosed, transmitted nor in any way made public without the written permission of the owner. any person in possession of this document acknowledges being bound by the obligation to treat it as confidential. »

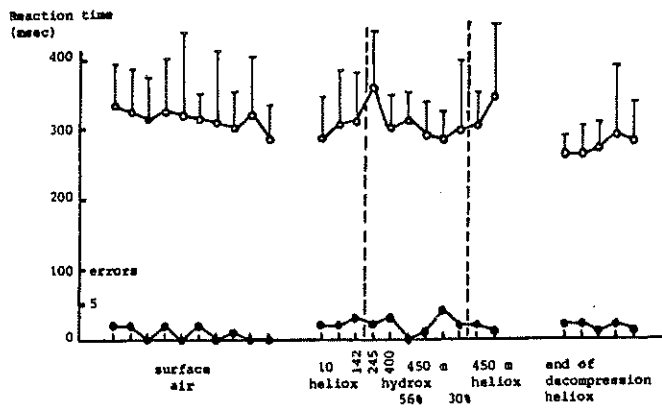

Individual performance on the Visual Choice Reaction Time test of the diver A1 during Hydra V expressed in thousandths of seconds (msec) and number of errors.

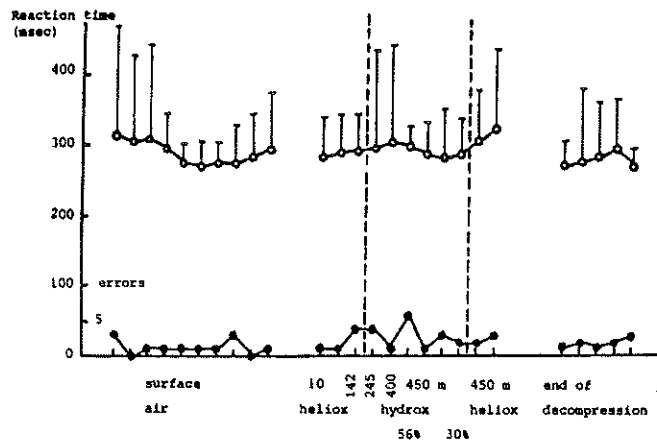

Individual performance on the Visual Choice Reaction Time test of the diver A2 during Hydra V expressed in thousandths of seconds (msec) and number of errors.

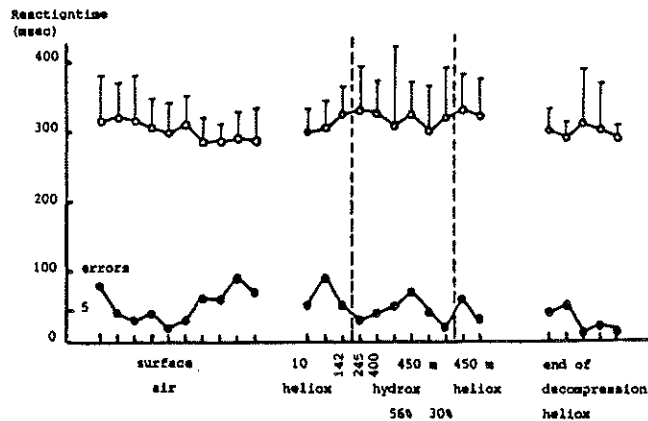

Individual performance on the Visual Choice Reaction Time test of the diver A3 during Hydra V expressed in thousandths of seconds (msec) and number of errors.

« THIS DOCUMENT IS THE PROPERTY OF COMEX, all information contained herein may neither be reproduced, used, disclosed, transmitted nor in any way made public without the written permission of the owner. any person in possession of this document acknowledges being bound by the obligation to treat it as confidential. »

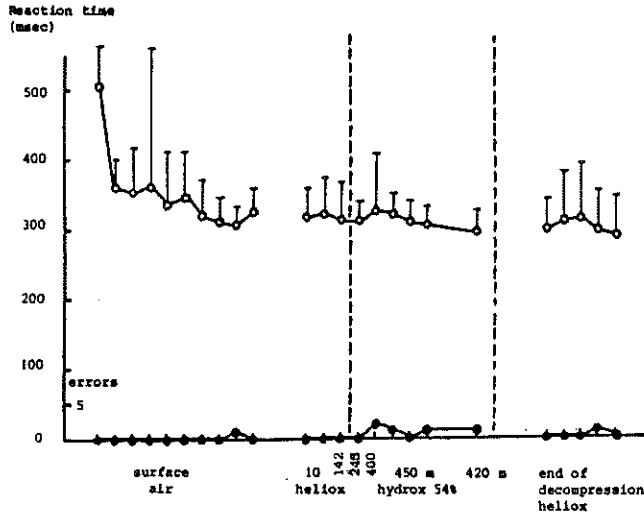

Individual performance on the Visual Choice Reaction Time test of the diver B1 during Hydra V expressed in thousandths of seconds (msec) and number of errors.

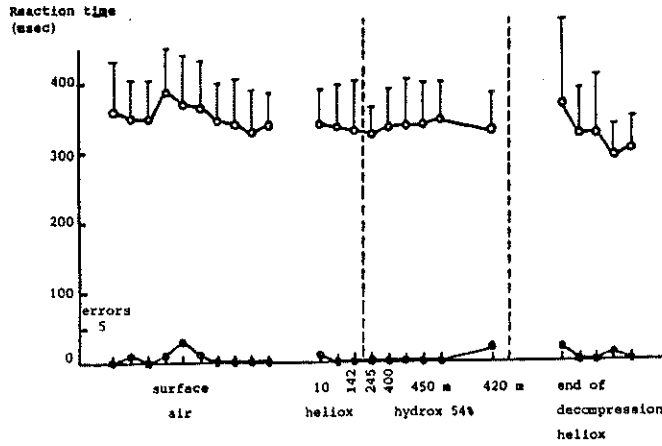

Individual performance on the Visual Choice Reaction Time test of the diver B2 during Hydra V expressed in thousandths of seconds (msec) and number of errors.

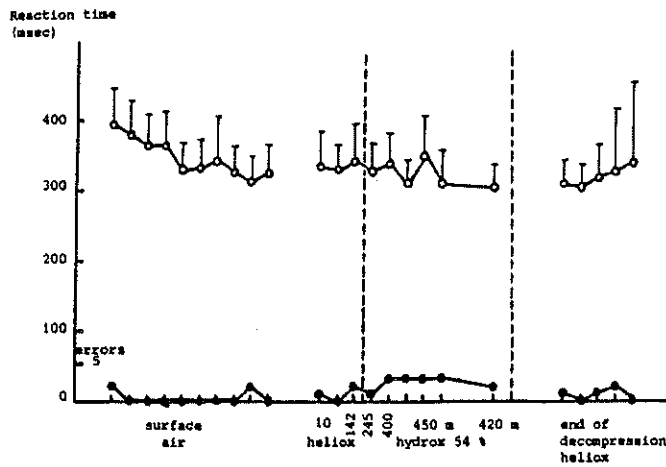

Individual performance on the Visual Choice Reaction Time test of the diver B3 during Hydra V expressed in thousandths of seconds (msec) and number of errors.

« THIS DOCUMENT IS THE PROPERTY OF COMEX, all information contained herein may neither be reproduced, used, disclosed, transmitted nor in any way made public without the written permission of the owner, any person in possession of this document acknowledges being bound by the obligation to treat it as confidential.

HYDRA V

VENTILATORY TOLERANCE TO EXERCISE

P. GIRY, EASSM-CERB, Toulon-Naval

VENTILATORY TOLERANCE TO EXERCISE DURING AN
HYDROGEN : HELIUM : OXYGEN SATURATION DIVE (HYDRA V).

P. GIRY (*), A. BATTESTI (*), H. BURNET (+) and R. HYACINTHE (*).

Using Hydrogen as a diluent gas for diving has been thought of since 1930 (1). The first actual human experimental dives using this diluent gas for Oxygen has been performed by the Swedish Navy (2). A series of bounce dives has been achieved by EDELL's team (3) and by FIFE (4).

Most of the animal experiments dealt with the neurologic effects of the gas (5) or the decompression problems (6). In this field, a French work (6) described a "toxic effect" attributed to the mixture, and further work in this area has been post-poned. Recent experiments did not find this toxicity (7, Gardette et al on rats, ROSTAIN et al on monkeys)(8). It seems that in this experiment (dive in H₂/O₂ at 30 ATA with a temperature of 29 °C), the results observed may be due to the combination of a very high narcotic potency of the gas (P_{H₂} = 29.5 ATA) and hypothermia. The use of Helium for deep diving stopped the urge for finding a new diving mixture.

The evidence of a density-related limitation to ventilation (9, 10) induced a search for a breathing gas lighter than Helium. Looking at Mendeleiev's table, it appears that the only candidate is Hydrogen. In the '80s, interest in Hydrogen has been renewed by this aspect of the problem and by the price of Helium. Two series of human experiments has been conducted in this field, one by the French diving company COMEX (HYDRA series, 11), the other by the Swedish Navy (12, 13). All the work performed in this area evidenced a narcotic power of the gas at pressure. However, none of these teams did study the putable improvement in tolerance to exercise provided by the mixture. The Swedish team did not observed any drastic increase in Vital

* EASSM-CERB, BP 610, 83 800 Toulon-Naval (France).

+ GIS de Physiologie Hyperbare, CNRS, Marseille (France)

Capacity (VC), Forced Expiratory Volume in 1 s (FEV1) nor tolerance to exercise.

The present experiment (HYDRA V, sponsored by IFREMER and DRET) is the first saturation dive using Hydrogen as part of the diluent gas. It intends to evidence the modifications in exercise tolerance induced by the use of a H₂ : He : O₂ breathing mixture (HYDROX) breathed at 46 ATA, as compared to a He : O₂ mixture (Heliox). Due to the narcotic effects of Hydrogen, P_{H2} has been maintained at 25 ATA. According to the theory of respiratory mechanics (10), the expected gain afforded by the ternary mixture could be of 10% to 15% at maximum ventilatory rates.

This situation is the only one known in which narcotic effects due to elevated P_{H2} (which may interfere with the regulation of ventilation) combine to decreased gas density (which should lead to increased ventilation). Therefore, no prediction can be made on the resulting ventilation at work.

I. MATERIAL and METHODS.

I.1. The dive.

The HYDRA V dive is a saturation dive at 46 ATA. It was planned to concern 2 teams of 3 divers each (teams A and B). It should include : controls for 3 days at 2 ATA breathing an Heliox mixture (CONFIN), compression to bottom pressure in 39 h using HYDROX mixture, stay in HYDROX mixture of 3 days, switch to Heliox for 3 days, then decompression on Heliox. Due to counter-diffusion and HPNS problems during the gas switch for team A, team B has not been submitted to the Heliox part of the experiment. Table I gives the scheduled situations.

Pressure ATA	stay days	PO ₂ ATA	P _{H2} ATA	P _{He} ATA	Temperature ° C	Code
2	3	.4	nil	1.6	28	CONFIN
46	2+1	.4	25	20.6	32	HYDROX
46	3	.4	nil	45.6	32	Heliox

Table I : Experimental situations scheduled for both teams (performed only by team A).

I.2. The divers.

Six divers volunteered in the experiment, 3 commercial divers from COMEX, 2 military divers, and 1 civilian diving instructor. Table II gives the characteristics of the divers.

Diver (Code)	Age years	Height m	Weight kg	VO ₂ max * ml.mn-1.kg	VC L	FEV1 L	MVV L.mn-1	Origin
A1	40	1.89	88	39.0	6.32	4.10	196	M.N.
A2	35	1.83	80	44.1	5.53	3.60	192	COMEX
A3	34	1.76	74	40.9	6.25	5.01	171	COMEX
B1	32	1.76	73	50.8	5.60	4.16	156	M.N.
B2	31	1.79	75	36.0	5.40	4.09	138	COMEX
B3	34	1.72	75	44.0	4.61	3.57	177	INPP

Table II : Divers anthropometry.

* indirect measurement according to ASTRAND (*)

M.N. : Marine Nationale (French Navy).

COMEX : COMEX commercial diver.

INPP : Institut National de Plongee Professionnelle (Diving Instructor).

I.3. The exercises and breathing resistances.

The protocol for the exercise tolerance tests has been identical to the one used during the previous 46 ATA French saturation dives (ENTEX series, 14, 15, 16).

In order to evidence any ventilatory benefit, ventilatory request has to be great enough. The ventilatory request has been achieved through 6 minutes muscular exercise runs on an electrically braked bicycle ergometer (SIEMENS) at preset workloads of 0, 75 and 110 or 150 W. Due to a defect in the regulation module of one of the bikes, the workloads requested in HYDROX has been 1.4 greater than in Heliox.

In order to attain the ventilatory limits of the subjects, external breathing resistances have been added, identical on both the inspiratory and expiratory sides of the breathing apparatus. These were plexiglass diaphragms, 1 mm thick, perforated by a calibrated orifice. The diameters have been chosen in such a way that the external resistances should be identical in CONFIN, HYDROX and Heliox. The goals were breathing resistances of 0 (R0), 10 (R2) and 15 (R3) cm H₂O*(L.s-1)⁻¹ for a sinusoidal breathing regimen of 40 L.mn-1 (Vt = 2.0 L, f = 20.mn-1) at the gas density to be used.

The different combinations tested are given in table III.

Situation	Workloads code Watts	Diaphragms code mm
CONFIN	W0 0	R0 40.0
	W1' 28	R2 10.0
	W2' 105	R3 8.0
	W2' 154	
	W2 210	
Heliox	W0 0	R0 40.0
	W1 75	R2 12.5
	W2' 110	R3 11.5
	W2 150	
HYDROX	W0 0	R0 40.0
	W1 105	R2 12.0
	W2' 154	R3 10.5
	W2 210	

Table III: Actual workloads and resistances
Imposed to the subjects
(W0' used during CONFIN. W2' used for R3)

The organization of a session is given in table IV.

Diver Workload Resistance

A1	W 0	R 0
	W 1	R 0
	W 2	R 0
A2	W 0	R 0
	W 1	R 0
	W 2	R 0
A3	W 0	R 0
	W 1	R 0
	W 2	R 0
A1	W 0	R 2
	W 1	R 2
	W 2	R 2

And so on ...

Table IV : Organisation of exercise runs

I.4. The respiratory measurements set up.

I.4.1. The ventilatory measurements.

The ventilatory measurements were performed using a "Bag-in-Box" system already described (14, 15, 16) equipped with a rolling seal spirometer. The system has been modified in such a way that it allowed P.1 measurements and breathing the pressure chamber gas during the 4 first minutes of exercise. Recording of the ventilatory parameters was done during the last 2 minutes of the exercise runs (steady state period). A gas sampling port in the mouthpiece allowed continuous sampling of the breathing gas in order to determine PetO2 and PetCO2 by mass spectrometry (RIBER QSX

« THIS DOCUMENT IS THE PROPERTY OF COMEX, all information contained herein may neither be reproduced, used, disclosed, transmitted nor in any way made public without the written permission of the owner, any person in possession of this document acknowledges being bound by the obligation to treat it as confidential. »

200). A gas sampling line for gas analysis was also set in the box (inhaled gas analysis) and in the bag (exhaled gas analysis) for computation of Oxygen consumption ($\dot{V}O_2$) after completion of the run.

Has been measured :

- tidal volume : V_t (in L BTPS),
- respiratory rate : f (in mn^{-1}),
- duration of inspiration : T_i (in s),
- mouth pressure : P (in mb).
- FO_2 and FCO_2 .

Has been computed :

- ventilation : $\dot{V}_E = V_t \times f$ (in $L \cdot mn^{-1}$),
- Oxygen consumption $\dot{V}O_2 = \dot{V}_E (F_i O_2 - F_e O_2)$ (in $L \cdot mn$ STPD),
- End Tidal Partial Pressure of CO_2 : $P_{et}CO_2 = FCO_2 \times$ Total pressure (in Torr),
- flow rates (\dot{V}) by numerical derivation of the volume signal,
- actual breathing resistances : P / \dot{V} .

I.4.2. The P.1 measurement.

The technique used for P.1 measurements has been identical to the one described by Lind (17). P.1 has been measured at random, never more frequently than every 3 breaths, and the average of the measures made during the last 2 mn of exercise considered as the true P.1.

I.5. Control of the subjects.

Immediate control of the subjects was obtained through 2 ways :

- instantaneous $P_{et}CO_2$, and control of the capnigram,
- measurement of heart rate by a 3 lead ECG.

II. RESULTS.

Only team A results will be presented here, because they are the only complete set. Team B subjects has not been submitted to the Heliox situation at 46 ATA. Therefore, the comparison between HYDROX and Heliox is not possible for them.

All the subjects but subject B3 were slightly euphoric in the HYDROX situation. The exercises has been considered as easier in HYDROX by all the subjects, even when the actual workloads were greater than in Heliox. However, some behavioral modification let us presume that there was a slight degree of narcosis in Hydrogen (difficulty to calibrate transducers, bursts of laughter during MVV measurements, etc...).

In team B, for a workload of 105 W and the medium range resistance R2, subject B did not felt that he had reached his limits ($f_c = 170$, $P_{et}CO_2 > 70$ Torr). He requested (but has not been allowed to) perform the highest workload. Subject B3 has been unable (due to psychological reasons) to perform any exercise. The full set of results is given in the annex.

II.1. Lung function.

The results of the ventilatory clinical investigation of the subjects are given in table V :

Diver	Volumic Mass g.L-1 (0°C)	Air 1ATA	HYDROX 46 ATA	Heliox 46 ATA
		1.23	6.4	8.7
A 1	VC	6.32	6.20	6.03
	FEV1	4.10	3.10	2.90
	MVV	202	33 (*)	78
A 2	VC	5.53	5.60	5.60
	FEV1	3.60	3.14	2.91
	MVV	192	58	66
A 3	VC	6.25	5.93	5.93
	FEV1	5.01	2.43	2.43
	MVV	171	42	45
B 1	VC	5.60	5.62	
	FEV1	4.16	2.53	Non exposed
	MVV	156	72	
B 2	VC	5.40	5.32	
	FEV1	4.09	2.60	Non exposed
	MVV	138	68	
B 3	VC	4.61		
	FEV1	3.57	Non measured	Non exposed
	MVV	177		

Table V : Lung volumes and flows.

Team B has not been exposed to Heliox.

(*) bursts of laught during all trials.

VC(HYDROX)/VC(Air)	=	.99 +/- .02 (m +/- 5d),
VC(Heliox)/VC(Air)	=	.97 +/- .03 ,
VC(HYDROX)/VC(Heliox)	=	1.01 +/- .02 ,
FEV1(HYDROX)/FEV1(air)	=	.67 +/- .15 ,
FEV1(Heliox)/FEV1(Air)	=	.67 +/- .11 ,
FEV1(HYDROX)/FEV1(Heliox)	=	1.05 +/- .04 ,
MVV(HYDROX)/MVV(Air)	=	.33 +/- .14 (with A1)
	=	.37 +/- .12 (except A1)
MVV(Heliox)/MVV(Air)	=	.33 +/- .07 ,
MVV(HYDROX)/MVV(Heliox)	=	.75 +/- .28 (with A1)

There no variation in VC between HYDROX and Heliox. The increase in FEV1 is at the limit of statistical significance. The decrease in MVV is not significant.

II.2. Tolerance to exercise :

In order to be able to compare the values between Heliox and HYDROX, it has been decided to interpolate the HYDROX values for workloads of 110 W and 150 W. Table VI gives the main results obtain for a workload of 150 W in Heliox (actual measurement) and HYDROX (interpolated).

		$\dot{V}E$	$\dot{V}O_2$	PetCO ₂	P.1
CONFIN	m	42.7	2.76	53.7	5.6
	sd	8.9	.34	7.0	.8
Heliox	m	43.6	2.24	57.0	3.8
	sd	14.5	.33	4.0	2.3
HYDROX	m	37.6	2.28	60.0	3.9
	sd	3.6	.04	5.3	1.2

Table VI : Ventilatory measurements without added external breathing resistances, for a workload of 150 W in Heliox (actual) and HYDROX (interpolated between 105 and 210 W) (team A).

It appears that in HYDROX (as compared to Heliox) :

- $\dot{V}O_2$ is not different,
- $\dot{V}E$ is slightly decreased (non significant).
- PetCO₂ is increased (P < .05),
- P.1 does not vary.

If CONFIN is considered as reference situation, ventilatory measurements in Heliox are closer to "normal" than the ones collected in HYDROX.

Table VII gives the same results for the 110 W workload with the maximal breathing resistance.

		$\dot{V}E$	$\dot{V}O_2$	PetCO ₂	P.1
CONFIN	m	29.9	2.00	57.6	4.9
	sd	1.0	.12	8.2	.3
Heliox	m	32.3	1.76	56.7	13.2
	sd	8.3	.14	2.9	1.8
HYDROX	m	29.6	1.94	62.3	9.3
	sd	6.5	.19	7.1	2.3

Table VII : Ventilatory measurements with maximal external resistance for a workload of 110 W in Heliox (actual) and HYDROX (interpolated between 105 and 154 W) (team A).

The results are the same than without resistance. P.1 is significantly decreased. $\dot{V}E$ is identical in CONFIN and in HYDROX. PetCO₂ is higher in HYDROX than in the 2 other situations. P.1 decreases with gas density.

Pooling all the measurements and comparing the HYDROX situation with the Heliox one using Student's paired t test gives :

- \dot{V}_E decreases by 8% +/- 8% (P = .2),
- PetCO₂ increases by 9% +/- 3% (P < .05),
- P.1 decreases by 27% +/- 10% (P = .02).

The analysis of the $\dot{V}_E = f(\dot{V}O_2)$ relationship on all the obtained results are given in table VIII :

R	n	Team A				Team A+B				
		a0	a1	r	P <	n	a0	a1	r	P <
CONFIN										
RO	9	10.5	11.1	.83	.01	18	5.2	13.1	.98	.01
R2	6	4.7	14.8	.95	"	15	3.5	14.9	.97	"
R3	8	4.1	13.1	.98	"	17	4.2	13.0	.98	"
Heliox										
RO	9	3.4	18.7	.94	"	non exposed				
R2	8	6.3	12.2	.97	"					
R3	9	8.4	13.9	.86	"					
HYDROX										
RO	9	3.2	15.3	.98	"	14	3.1	15.0	.98	.01
R2	9	5.4	12.2	.98	"	15	5.8	12.1	.98	"
R3	9	3.6	13.2	.95	"	12	4.0	13.2	.96	"
ALL RESISTANCES POOLED										
CONFIN										
	22	5.8	13.2	.94	.01					
Heliox										
	26	8.1	12.3	.92	.01					
HYDROX										
	27	3.7	13.8	.96	.01					
ALL ENVIRONMENTS POOLED										
RO	26	6.3	14.2	.92	.01					
R3	26	7.2	12.1	.93	"					

Table VIII : Relationship $\dot{V}_e = a_0 + a_1(\dot{V}O_2)$ (all results)
 a_0 in L.mn-1 (BTPS).
 a_1 in L.mn-1 (BTPS)/L.mn-1 (STPD) of O₂.

The slopes do not differ depending upon the medium. The ordinate for $\dot{V}O_2 = 0$ is greater in heliox than in HYDROX.

II.2. Neuro-muscular command of ventilation :

The neuro-muscular command of ventilation has been appreciated by a multiple correlation technique. Results are given in tables IX to XII.

Team A						Team A+B				
R	n	a0	a1	r	P <	n	a0	a1	r	P <
CONFIN										
RO	9	-	17.3	.94	.01	18	-9.3	20.0	.92	.01
R2	8	-24.2	22.0	.93	"	18	-4.0	16.8	.77	.05
R3	8	-11.6	19.2	.87	"	17	-7.3	16.3	.87	.01
Heliox										
RO	9	- 1.6	20.8	.69	.05	Non exposed				
R2	8	-23.4	52.4	.94	.01					
R3	9	5.0	7.5	.88	"					
HYDROX										
RO	9	- 4.8	21.2	.78	.01	14	-6.6	22.8	.68	.01
R2	9	+ 6.9	8.1	.89	"	14	+7.8	10.7	.75	"
R3	9	- 2.6	10.6	.97	"	12	+6.3	8.3	.79	"
ALL RESISTANCES POOLED										
CONFIN										
	22	- 6.8	17.8	.83	.01					
Heliox										
	26	+10.6	7.1	.58	.01					
HYDROX										
	25	+ 9.2	8.4	.68	.01					
ALL ENVIRONMENTS POOLED										
RO	26	+15.1	9.8	.76	.01					
R3	24	+ 3.2	9.6	.78	"					

Table IX : Relationship $\dot{V}_E = a_0 + a_1(\sqrt{P.1})$ (all results)
 a_0 in L.mn-1 (BTPS)
 a_1 in L.mn-1 (BTPS)/ mb.

The efficiency of the command (estimated by the relationship between \dot{V}_E and $\sqrt{P.1}$) is greater in CONFIN than in HYDROX, slightly greater in HYDROX than in Heliox.

As shown in the preceding chapter, P.1 is decreased in HYDROX as compared to Heliox. We tried to analyze the influence of external parameters (role of the workload and of the diaphragms) and the influence of endogenous parameters (the actual inspiratory resistance ResI), and the breathing pattern (V_t/VC and T_i) on P.1. The analysis is done on log-log transforms.

	n	constant	log(W)	log(dia)
CONFIN	22	(r = .68 =)		
coef.		1.4	.22	- .25
t stat.		3.40 (*)	3.97 (=)	- 1.71 NS
Heliox	26	(r = .84 =)		
coef.		2.5	.33	- .68
t stat.		4.19 (=)	6.52 (=)	- 3.52 (*)
HYDROX	25	(r = .84 =)		
coef.		2.0	.33	- .58
t stat.		4.40 (*)	6.74 (=)	- 2.99 (*)

Table X : log(P.1) and environmental parameters.

NS non significant

(*) P < .05 ; (*) P < .01 ; (=) P < .001

W actual workload in Watts

dia : diameter of resistors in mm.

It appears that the role of the mechanical workload is not different in HYDROX or Heliox, even if it is greater than in CONFIN. The influence of the diaphragms is greater in Heliox than in HYDROX, which had to be expected.

	n	constant	log(ResI)	log(Vt/VC)	log(Ti)
CONFIN	22	(r = .90 =)			
coef.		3.5	.18	.84	1.6
t stat.		14.1 (=)	3.89 (=)	4.68 (=)	8.22 (=)
Heliox	26	(r = .88 =)			
coef.		3.6	.47	1.3	1.6
t stat.		8.70 (=)	5.75 (=)	4.13 (=)	5.96 (=)
HYDROX	25	(r = .89 =)			
coef.		3.9	.36	1.4	1.7
t stat.		9.66 (=)	4.69 (=)	4.69 (=)	5.67 (=)

Table XI : log(P.1) and respiratory measurements

(*) P < .01 ; (=) P < .001

ResI in cm H2O.(L.s-1)-1.

Ti in seconds.

Vt/VC dimensionless.

Only the actual inspiratory resistances show any differential effect. It is greater in Heliox than in HYDROX. The same external charge will give greater P.1 in Heliox environment.

The role of the CO2 stimulus on P.1 (log-log transform) is described in table X. Even if the slope of the relationship is greater in HYDROX than in Heliox, the origin ordinate (which represent a multiplicative coefficient) is greater in Heliox. If one recalculates P.1 for a given PetCO2, it appears that it is always greater in Heliox than in HYDROX.

Situation	n	a0	(t stat)	a1	(t stat)	r	P
CONFIN	22	.68	.73	.017	.98	.21	NS
Heliox	26	- 1.36	1.69	.054	3.59	.57	(*)
HYDROX	25	- 2.86	3.8	.075	5.73	.76	(=)

Table XII : Relationship : $\log(P.1) = a_0 + A_1 \log(\text{PetCO}_2)$
 (*) $P < .01$; (=) $P < .001$.

IV. DISCUSSION.

IV.1. Lung function.

The Swedish team (25) observed a slight increase in VC at 1.3 MPa, which they attributed to the effects of the stressful situation. We do not ^{observe} the same increase. However, our subjects were under saturation conditions since 2 days, and the stress effect was deleted.

The increase in FEV1 is at the limit, in favor of HYDROX. These results are comparable to the one observed by Dahlback during the Swedish dive and agrees with the purely mechanistic theory (18).

MVV in our situation does not varies significantly, which does not correlates with Dahlback's results nor with the theoretical predictions (24). It seems that the behaviour of our divers (mainly in subject A1) did not allowed performing correctly the test, which may explain this discrepancy. MVV is a test which depends largely on the breathing pattern of the subject. Obtaining reproducible results needs training an repetition of the test in order to choose the best value. In the present experiment, if the subject's cooperation cannot be doubted, it seems that their self-control has not been as strict as in the 1 ATA or CONFIN measurements.

IV.1. Ventilation during exercise.

It appears from these results that in HYDROX, \dot{V}_E tends to be smaller and PetCO2 is greater than in Heliox. This can be interpreted as an alveolar hypoventilation.

According to the purely mechanistic theory of the limitation to ventilation (18, 19, 20, 21, 22, 23), the intra-thoracic resistances are smaller in HYDROX than in Heliox. Therefore, breathing should be easier, and ventilation near the physiological limits of the subjects should be greater.

The exercise runs were reported by the divers less difficult

in HYDROX than in Heliox. This is in agreement of Dahlback's observations at 13 ATA (25). Ornhagen reported (13) a slight degree of narcosis in the Swedish dive.

During exercise runs without added external breathing resistances, in HYDROX, we observe a tendency to alveolar hypoventilation (\dot{V}_E tends to decrease, $P_{et}CO_2$ is increased) as compared to Heliox. In such a situation, the only breathing resistance are intrathoracic, which should be lower, according to the mechanistic theories of the limitation to ventilation. $P.1$ is identical in both situations. The impedance of the thoraco-pulmonary system (estimated by the slope of the \dot{V}_E versus $\sqrt{P.1}$ relationship) is slightly smaller in HYDROX than in Heliox. Mechanical situation at lung level is therefore not the cause of these results. Due to elevated $P_{et}CO_2$ in HYDROX, $P.1$ should have increased. It seems that the sensitivity to CO_2 in HYDROX has been decreased. Such a phenomenon has already been described in rats for PH_2 as low as 8.3 ATA (29). This could be explained by a pharmacological effect of Hydrogen on the CO_2 sensitive structures. The Swedish team did not observe any modification in exercise tolerance at 13 ATA. However, the exposure duration to Hydrogen mixture was very short (less than 1/2 h), PH_2 was in the low narcotic potency range, total pressure was low, so that the ventilatory limit to exertion was far from to be reached.

With added external resistances, we observe the same phenomenons than without resistance, but including a significant decrease in $P.1$. The multiparameter regression analysis shows that the actual inspiratory resistances are of less importance in HYDROX than in Heliox. This, with the subjective reports of the subjects and the clinical observation of their behavior supports the hypothesis of an hydrogen induced narcosis, as previously reported for lower PH_2 by Fructus (11) and Ornhagen (12). This narcosis diminishes the reactivity of the CNS (28), even on the vegetative system (29) and, for a given combination of exercise and workload, the ventilatory command ($P.1$) resulting from the different stimuli is less than in Heliox (situation in which HPNS may induce an hyperexcitability of the same structures). Even with a decreased impedance of the respiratory

tract, \dot{V}_E is less, and a slight alveolar hypoventilation appears, leading to increased $P_{et}CO_2$. Apparently, the feed-back of $P_{et}CO_2$ on $P_{.1}$ is included in the structures implied by this narcosis.

It is questionable if there is a decreased ventilation in HYDROX or an increased ventilation in the Heliox situation? The comparison of \dot{V}_E and $P_{et}CO_2$ measurements without resistances obtained at depth with the one obtained at 2 ATAs (CONFIN) shows that the Heliox situation is closer to CONFIN than HYDROX is. This implies that in the HYDROX situation, there is a decreased ventilation. It seems that pressure modifies the reactivity of the respiratory system ($P_{.1}$ is lower in the 2 sets of measurements at depth). Hydrogen depresses this system (decrement in the $P_{.1}/P_{et}CO_2$ relationship as compared to Heliox).

With added external resistances, the situation is more complex. It seems that in Heliox, there is an hyperexcitability of the respiratory system (increased $P_{.1}$ and \dot{V}_E as compared to CONFIN). This does not lead to alveolar hyperventilation ($P_{et}CO_2$ remains at the same level). This increased ventilation may be a compensatory reaction to the decreased gas diffusivity at the alveolar level due to increased gas density (23). The gain in alveolar diffusivity due to a lighter gas (hydrogen) is too small to compensate for the narcotic effects of the gas.

CONCLUSION.

This first Hydrogen Helium Oxygen saturation dive to 46 ATA gives results which cannot be explained by the purely mechanistic theories of the limitation to ventilation in hyperbaric environments.

It is the only known situation in which an increased narcotic potency combines with a decreased gas density.

It seems that the high P_{H_2} (25 ATA) encountered is responsible of a narcosis which can be detected by the clinical observation of the subjects. This hydrogen induced decrease in CNS reactivity has implications on the neurologic command to ventilation. For a same exercise and breathing resistance, in HYDROX, $P_{.1}$ is smaller than in Heliox. The density-related decrease in thoracic impedance is not sufficient to compensate the decreased command, and a slight

hypoventilation, with increased $P_{et}CO_2$ occurs.

It seems that the neurological modifications completely masked the expected theoretical benefits of the lighter gas mixture.

It is questionable if the same phenomena would occur with lower P_{H_2} and if any kind of narcosis may have the same effects on the respiratory system. What is the optimal P_{H_2} not to be overcome in order to keep the mechanical benefits of the lightest gas known ?

- A 1 -

- ANNEX -

Individual results of the measurements done during the HYDRA V experimental dive (Hydrogen/Helium/Oxygen, 46 ATA, PO₂ = .4 ATA).

- Res : diameter of the diaphragms inserted in both the inspiratory and expiratory part of the breathing system.
- W : actual mechanical workload imposed (in Watts),
- fc : mean cardiac frequency (in mn-1),
- $\dot{V}O_2$: mean oxygen consumption (in L.mn-1 STPD),
- $\dot{V}E$: minute ventilation (in L.mn-1 ATPS),
- Vt : tidal volume (in L ATPS),
- fr : mean breathing frequency (in mn-1),
- PetCO₂ : mean PetCO₂ (in Torr),
- P.i : mean occlusion pressure (in mb),
- Vt/ti : mean inspiratory flow (in L ATPS.s-1)
- Pi : mean of the average inspiratory pressures (in mb),
- Pe : mean of the average expiratory pressures (in mb).

These results are the mean of the values of the concerned parameter measured during the last 2 minutes of 6 minutes exercise runs.

- A 2 -

CONFINEMENT : 2 ATA Heliox, volumic mass at 0°C = 0.86 g.L-1, t = 28°C

Res mm	W Watts	sujet	fc mn-1	VQ2 (1)	VE (2)	Vt L	fr mn-1	PetCO2 (3)	P.1 mb	Vt/ti L.mn-1	Pi mb	Pe mb	
40.0	28	A1	72	1.08	17.6	3.32	5.3	54.1	3.9	.8	1.8	1.9	
..	105	..	90	2.56	33.5	3.38	9.9	60.6	3.5	1.4	3.6	1.6	
..	154	..	106	3.06	37.8	3.35	11.3	61.6	6.5	1.8	4.1	2.0	
..	210	..	124	3.76	46.8	3.54	13.2	62.4	7.5	1.9	3.6	2.3	
..	28	A2	no measurements						45.2	3.4	1.2	.3	.3
..	105	..	86	1.79	34.8	2.34	14.9	46.5	4.3	1.3	2.1	2.5	
..	154	..	112	2.41	42.2	2.79	15.1	48.3	4.9	1.5	2.4	3.3	
..	210	..	130	2.93	54.0	2.80	19.3	50.2	8.4	1.7	2.8	4.2	
..	105	A3	106	1.94	30.9	3.06	10.1	50.4	4.6	1.3	2.5	2.4	
..	210	..	141	3.11	48.9	3.38	14.5	53.0	7.4	1.8	3.5	3.7	
..	0	B1	71	.38	8.9	1.08	8.3	42.0	.7	.4	.7	.6	
..	75	..	89	1.10	18.8	2.06	9.1	51.4	1.8	.9	1.4	1.3	
..	150	..	124	2.24	35.2	2.33	15.1	54.7	3.6	1.4	2.0	1.9	
..	0	B2	88	.33	7.9	1.46	5.4	37.7	1.2	.4	.7	.5	
..	75	..	103	1.22	18.3	3.02	6.0	52.3	3.6	.7	1.4	1.0	
..	150	..	130	2.19	32.3	4.23	7.7	61.6	5.4	1.3	2.7	1.9	
..	0	B3	48	.40	10.3	.97	10.6	33.8	1.3	.5	.7	1.0	
..	75	..	67	1.17	20.0	2.18	9.2	45.6	3.6	.8	1.7	1.0	
..	150	..	103	2.06	36.5	2.66	18.7	48.3	6.5	1.5	3.0	1.6	
10.0	0	A2	66	.52	13.7	.80	17.0	42.5	4.2	.6	1.8	1.2	
..	105	..	99	2.14	35.4	2.30	15.4	49.7	7.0	1.2	4.3	6.0	
..	210	..	143	2.94	56.4	2.80	20.1	46.4	11.7	1.5	18.4	49.5	
..	0	A3	81	.85	18.0	1.70	10.6	39.9	2.9	.7	2.8	1.5	
..	105	..	119	2.02	31.9	2.94	10.9	51.4	5.9	1.3	8.8	4.8	
..	210	..	153	2.74	38.9	3.42	11.4	60.6	10.0	1.5	15.1	9.6	
..	0	B1	67	.37	8.2	1.18	7.0	42.2	1.1	.3	1.2	.6	
..	75	..	88	1.20	19.6	2.30	8.7	53.1	2.4	.7	3.1	2.5	
..	150	..	126	2.20	36.9	3.30	11.0	55.2	2.3	1.4	6.3	5.9	
..	0	B2	93	.40	9.8	1.70	5.6	41.2	2.4	.3	1.5	.6	
..	75	..	106	1.20	18.9	3.60	5.3	58.4	7.1	.8	3.7	1.3	
..	150	..	142	2.30	34.1	4.40	7.7	67.6	6.9	1.5	9.5	4.4	
..	0	B3	57	.46	10.3	1.48	7.0	40.2	1.4	.4	1.5	.7	
..	75	..	80	1.30	26.0	1.80	14.1	45.4	3.4	1.0	4.6	3.0	
..	150	..	112	2.20	35.7	3.00	12.1	56.6	6.8	1.4	6.8	4.1	
..	0	A1	73	.57	13.4	3.18	4.2	50.8	1.4	.5	1.9	1.0	
..	105	..	97	2.05	28.1	4.16	6.7	67.2	4.9	1.1	11.8	4.5	
..	210	..	130	3.37	50.8	4.72	10.8	62.9	11.0	2.1	33.6	17.8	
..	0	A2	64	no measurements					41.5			2.2	.6
..	105	..	89	1.82	30.2	3.15	9.6	51.5	4.8	.9	10.6	22.6	
..	210	..	139	3.19	47.7	3.22	14.0	57.8	8.8	1.6	21.9	53.4	
..	0	A3	77	.56	10.1	1.36	7.4	40.0	3.3	.5	3.0	1.5	
..	105	..	118	1.97	29.4	3.03	9.7	53.5	4.5	1.2	19.9	9.9	
..	210	..	157	3.04	39.4	3.59	11.0	65.1	3.9	1.4	49.2	23.3	
..	0	B1	60	.28	6.1	1.25	4.8	39.5	1.2	.3	1.5	1.0	
..	75	..	82	1.19	17.3	2.51	6.9	50.5	1.1	.7	4.5	4.4	
..	150	..	114	1.85	23.9	2.43	9.8	59.2	2.4	1.0	8.1	10.5	
..	0	B2	97	.34	8.2	1.74	4.7	37.8	1.5	.4	2.5	1.3	
..	75	..	106	1.18	19.5	3.41	5.7	50.2	3.6	.8	5.6	3.3	
..	150	..	144	2.31	35.3	3.66	9.7	59.9	9.0	1.4	15.3	11.8	
..	0	B3	52	.41	11.6	1.09	10.6	34.2	1.2	.4	2.5	1.4	
..	75	..	70	.82	18.0	2.29	7.9	47.0	3.9	.7	5.4	2.9	
..	150	..	100	2.07	33.4	2.57	13.0	50.8	7.9	1.4	13.8	8.5	

« THIS DOCUMENT IS THE PROPERTY OF COMEX, all information contained herein may neither be reproduced, used, disclosed, transmitted nor in any way made public without the written permission of the owner, any person in possession of this document acknowledges being bound by the obligation to treat it as confidential. »

- A 3 -

HYDROX : 46 ATA, volumic mass at 0°C = 6.49 g.L-1, t = 32°C

Res mm	W Watts	sujet	fc mn-1	VO2 (1)	VE (2)	Vt L	fr mn-1	PetCO2 (3)	Pi mb	Vt/ti L.mn-1	Pi mb	Pe mb
40.0	0	A1	69	.62	11.3	2.59	4.3	42.7	1.4	.5	.8	.7
"	105	"	97	1.80	26.1	3.59	7.3	65.9	4.6	1.2	2.8	2.3
"	210	"	133	3.19	49.8	3.31	15.1	62.8	6.5	1.8	2.5	2.7
"	0	A2	73	.70	17.6	1.10	16.3	40.7	1.5	.7	.9	1.2
"	105	"	110	1.56	29.8	2.52	11.8	52.8	2.7	1.0	1.8	4.1
"	210	"	158	3.42	61.6	2.93	21.0	56.5	4.4	2.0	2.9	2.6
"	0	A3	71	.64	12.7	1.43	8.8	46.6	1.0	.5	1.0	.9
"	105	"	106	1.78	30.1	3.15	9.6	58.3	1.1	1.2	2.4	2.3
"	210	"	147	3.02	46.3	3.79	12.2	65.4	6.7	1.8	3.3	3.7
"	0	B1	90	.56	10.9	1.20	9.1	47.4	1.7	.5	.9	.7
"	105	"	134	2.70	41.7	3.03	13.8	64.6	2.5	1.5	2.2	2.2
"	210	"	168	3.39	53.0	2.58	20.6	70.1	2.7	1.8	2.5	2.6
"	0	B2	104	.52	10.6	.80	12.9	46.7	2.3	.4	.7	.5
"	105	"	144	2.39	35.2	3.17	11.4	69.1	2.9	1.3	2.1	2.1
"	210	"	exercice not performed due to physiological reasons									
"	---	B3	exercice not performed due to psychological reasons									
12.0	0	A1	76	.47	12.6	3.39	3.7	46.7	1.7	.6	5.0	2.4
"	105	"	103	1.68	28.7	3.66	7.8	60.6	4.6	1.2	20.3	8.9
"	210	"	131	2.97	42.7	2.89	14.8	66.1	14.8	1.6	28.4	17.2
"	0	A2	71	.58	12.1	1.33	9.1	42.8	2.2	.5	3.5	4.2
"	105	"	110	2.07	32.5	2.95	11.0	55.7	8.3	1.0	16.4	28.2
"	210	"	135	3.11	44.7	2.67	16.7	65.0	18.9	1.3	35.4	64.5
"	0	A3	67	.86	12.5	1.66	7.5	38.9	1.3	.5	5.2	2.6
"	105	"	102	1.83	26.6	3.17	8.4	63.8	1.7	.8	22.8	15.1
"	210	"	160	3.04	38.6	3.39	11.4	73.9	23.0	1.4	33.5	29.8
"	0	B1	87	.49	11.5	1.41	8.2	43.9	1.3	.5	3.9	1.7
"	105	"	115	1.93	27.3	2.54	10.7	65.7	3.1	1.0	12.5	8.9
"	210	"	152	2.78	37.3	2.26	16.6	72.5	2.5	1.3	21.6	17.0
"	0	B2	91	.37	11.8	1.23	9.6	46.7	1.4	.4	3.1	.9
"	105	"	157	2.40	39.0	3.51	11.1	71.5	2.7	1.4	21.1	14.4
"	210	"	exercice not performed due to physiological reasons									
"	---	B3	exercice not performed due to psychological reasons									
10.5	0	A1	67	.65	10.9	2.55	4.3	47.0	.8	.5	6.6	2.2
"	105	"	100	1.88	25.1	3.33	7.5	68.6	9.3	1.0	20.5	10.8
"	154	"	126	2.63	34.2	3.01	11.4	69.2	12.9	1.4	23.5	17.0
"	0	A2	67	.47	11.3	1.30	8.7	41.7	2.1	.4	4.0	5.5
"	105	"	113	2.06	35.4	2.60	14.0	54.0	10.7	1.2	17.7	28.6
"	154	"	142	2.54	43.4	2.81	15.4	61.1	16.5	1.4	24.0	38.4
"	0	A3	69	.48	9.5	1.38	6.9	46.0	1.8	.4	4.2	1.8
"	105	"	109	1.67	25.3	3.30	7.6	62.8	6.4	.8	24.0	19.8
"	154	"	136	2.37	30.4	3.65	8.3	70.6	10.4	1.1	29.3	35.1
"	0	B1	88	.42	10.6	1.25	8.5	45.8	.6	.4	1.6	.7
"	105	"	136	2.27	35.9	2.35	15.3	69.0	2.5	1.4	4.6	18.1
"	154	"	154	2.79	28.9	1.70	16.6	77.5	2.3	1.1	18.7	13.6
"	---	B2	exercices not performed due to physiological reasons									
"	---	B3	exercices not performed due to psychological reasons									

- A 4 -

Heliox : 46 ATA, volumic mass at 0°C = 8.71 g.L-1, t = 32°C

Res mm	W Watts	suje t	fc mn-1	VO2 (1)	VE (2)	Vt L	fr mn-1	PetCO2 (3)	P.1 mb	Vt/ti L.mn-1	Pi mb	Pe mb	
40.0	0	A1	76	.29	7.5	1.46	5.2	41.1	.4	.3	.5	.5	
"	75	"	92	1.29	20.9	4.10	5.1	55.7	2.3	1.0	2.1	1.0	
"	150	"	139	2.04	35.0	3.33	10.8	61.8	6.2	1.5	3.3	2.0	
"	0	A2	85	.41	15.2	1.01	15.1	36.2	1.6	.6	.9	1.2	
"	75	"	99	1.52	40.6	2.68	15.2	41.1	2.6	1.2	2.5	3.7	
"	150	"	133	2.62	60.4	2.95	20.5	49.8	3.6	1.9	3.6	5.9	
"	0	A3	83	.32	10.9	1.06	10.3	37.4	.9	.5	.9	.6	
"	75	"	98	1.17	23.1	2.95	7.8	49.6	1.0	.8	2.2	1.4	
"	150	"	137	2.06	35.4	3.23	11.0	59.1	1.6	1.3	4.2	3.1	
12.5	0	A1	84	.46	9.4	2.26	4.2	42.6	1.5	.4	2.6	2.3	
"	75	"	103	1.54	20.9	3.44	6.1	59.6	5.1	1.0	17.4	7.5	
"	150	"	155	2.85	41.1	2.45	16.8	74.1	22.0	1.5	53.7	7.7	
"	0	A2	77	.66	16.7	1.59	10.5	37.7	4.7	.6	4.5	3.0	
"	75	"	102	2.89	42.5	2.40	17.7	49.2	21.5	1.4	20.1	11.7	
"	150	"		exercise not performed				(pain in the knee)					
"	0	A3	90	.76	16.9	2.19	7.7	41.9	4.1	.5	10.4	2.3	
"	75	"	117	1.27	24.2	2.74	8.8	51.8	5.6	.9	18.2	9.7	
"	110	"	134	1.95	29.4	3.08	9.6	57.1	7.5	.9	24.3	17.1	
11.5	0	A1	88	.44	15.9	3.16	5.1	34.6	1.1	.6	7.8	5.5	
"	75	"	102	1.23	20.0	4.29	4.6	59.3	5.0	.9	16.7	6.9	
"	110	"	128	1.75	27.3	3.77	7.3	57.9	12.0	1.2	27.4	14.9	
"	0	A2	85	.36	17.3	2.42	7.2	31.2	1.3	.6	8.0	30.8	
"	75	"	104	1.43	35.7	2.66	13.4	45.8	11.8	1.1	17.3	47.9	
"	110	"	129	1.90	41.9	3.14	13.3	53.4	15.3	1.4	29.4	45.0	
"	0	A3	76	.24	9.2	1.25	7.4	39.5	1.1	.4	5.2	2.6	
"	75	"	97	1.32	23.6	2.87	8.2	55.3	10.4	.9	22.5	12.6	
"	110	"	123	1.62	27.6	2.96	9.3	58.9	12.4	1.1	25.5	15.6	

- A 5 -

- ANNEXE 2 : INTERPOLATED VALUES -

CONFIN : 2 ATA HélioX, volumic mass at 0°C = 0.86 g.L-1, t = 28°C

Res mm	W watts	subject	fc mn-1	VO2 (1)	VE (2)	Vt L	Fr mn-1	PetCO2 (3)	P.1 mb
40.0	110	A1	92	2.61	33.9	3.38	10.0	60.7	3.8
"	150	"	105	3.02	37.4	3.35	11.2	61.5	6.3
"	110	A2	114	2.46	43.4	2.79	15.5	46.7	4.4
"	150	"	129	2.89	53.0	2.80	19.0	48.1	4.8
"	110	A3	107	1.99	31.6	3.07	10.3	50.5	4.7
"	150	"	119	2.38	37.6	3.18	11.7	51.4	5.6
10.0	110	A2	101	2.17	36.3	2.32	15.6	49.6	7.2
"	150	"	115	2.44	43.3	2.49	17.2	48.5	8.8
"	110	A3	120	2.05	32.2	2.96	10.9	51.8	6.1
"	150	"	132	2.29	34.5	3.12	11.1	54.8	7.4
8.0	110	A1	98	2.11	29.0	4.18	6.9	67.0	5.1
"	150	"	109	2.55	36.6	4.37	8.2	65.6	7.2
"	110	A2	91	1.88	30.9	3.15	9.8	51.8	5.0
"	150	"	108	2.33	36.8	3.18	11.2	53.9	6.3
"	110	A3	120	2.01	29.8	3.05	9.8	54.0	4.5
"	150	"	133	2.37	33.1	3.24	10.2	57.8	4.3

HYDROX : 46 ATA , volumic mass at 0°C = 6.49 g.L-1, t = 32°C

Res mm	W watts	subject	fc mn-1	VO2 (1)	VE (1)	Vt L	Fr mn-1	PetCO2 (3)	PO.1 mb
40.0	110	A1	99	1.86	27.1	3.58	7.6	65.8	4.7
"	150	"	110	2.32	35.0	3.49	10.2	64.7	5.3
"	110	A2	112	1.64	31.1	2.54	12.2	52.9	2.8
"	150	"	128	2.26	41.7	2.67	15.2	54.2	3.3
"	110	A3	108	1.83	30.8	3.18	9.7	58.6	1.3
"	150	"	121	2.25	36.2	3.39	10.6	61.0	3.2
12.0	110	A1	104	1.73	29.3	3.63	8.1	60.8	5.0
"	150	"	113	2.16	33.9	3.37	10.4	62.7	8.4
"	110	A2	111	2.11	33.0	2.94	11.2	56.1	8.7
"	150	"	119	2.46	37.1	2.85	13.1	59.2	12.3
"	110	A3	104	1.88	27.1	3.18	8.5	64.2	2.6
"	150	"	124	2.28	31.1	3.25	9.5	67.6	9.7

- A 6 -

Héliox : 46 ATA, volumic mass at 0°C = 8.71 g.L-1, t = 32°C.

Res mm	W Watts	Sujet	fc mm-1	$\dot{V}O_2$ (1)	$\dot{V}E$ (2)	Vt L	Fr mm-1	PatCO2 (3)	PO.1 mb
40.0	110	A1	114	1.64	27.5	3.74	7.8	58.5	4.1
"	150	"	139	2.04	35.0	3.33	10.8	61.8	6.2
"	110	A2	115	2.03	49.8	2.81	17.7	45.2	3.1
"	150	"	133	2.62	60.4	2.95	20.5	49.8	3.6
"	110	A3	116	1.59	28.8	3.08	9.3	54.0	1.3
"	150	"	137	2.06	35.4	3.23	11.0	59.1	1.6
12.5	110	A1	127	2.15	30.3	2.98	11.1	66.4	13.0
"	150	"	155	2.85	41.1	2.45	16.8	74.1	22.0
"		A2	non	calculable		by		interpolation.	
11.5		A1, A2, A3	non	calculable		by		interpolation.	

- B 1 -

- REFERENCES -

- 1- Case E.M. and Haldane J.B.S. Human physiology under high pressure. J. Hyg. 41 : 225-249 (1941).
- 2- Zetterstrom A. Deep-sea diving with synthetic gas mixtures. Mil. Surg. 103 : 104-106 (1948).
- 3- Edell P.O., Holland J.M., Fife W.B., Fischer C.L. Preliminary studies of hydrogen-oxygen breathing mixtures for deep sea diving. In : The working diver. Symposium proceedings. Spalsbury D. (ed). Washington D.C. Marine technology society. : 257-270 (1972).
- 4- Fife W.P., Edwards M.S., Mezzino M.J. The use of non explosive mixtures of hydrogen and oxygen for deep diving. In : Proceedings of diver's gas purity symposium. Columbus (Ohio), Battelle Columbus Laboratories (1976).
- 5- Brauer R.W., Way R.O. Relative narcotic potencies of hydrogen, helium, nitrogen and their mixtures. J. Appl. Physiol. 29 (1) : 23-31 (1970).
- 6- Michaud A., Le Chuiton J., Parc A., Barthélémy L., Balouet G., Girin E., Corriol J., Chouteau J. Bilan d'une expérimentation animale de plongées aux mélanges hydrogène-oxygène. P.V. N° 03/73/GERS, CEPisner, BP 5, 83 800 Toulon-Naval (1973).
- 7- Risso J.J., Geneuil P., Dumas C., Chaumont A. et Brue F. Recherche d'un effet réducteur des fortes pressions d'hydrogène sur le glutathion érythrocytaire. Rapport CERB N°85-17, CERB, BP 610, 83 800 Toulon-Naval (France), (1985).
- 8- Rostain J.C. et Naquet R. Resultats préliminaires d'une étude comparative de l'effet des mélanges oxygène-hélium et oxygène-hydrogène et des hautes pressions sur le babouin Papio papio. In : Proc. des 3ème Journées Internationales d'Hyperbarie et de Physiologie Subaquatique, Fructus X. (ed.), Doin (Paris) : 44-49 (1972)
- 9- Lambertsen C.J., Gelfand R., Peterson R., Strauss R., Wright W.B., Dickson J.G., Puglia C., Hamilton R.W. Human tolerance to He, Ne and N2 at respiratory gas densities equivalent to HeO2 breathing at depths to 1200, 2000, 3000, 4000 and 5000 feet of sea water (Predictive Studies III). Aviat. Space Environ. Med. 48 (9) : 843-855, (1977).
- 10- Broussolle B., Hyacinthe R., Giry P., et col. La ventilation pulmonaire en plongée profonde. Med. Aéropat. Med. Sub. Hyp. : XX (80) : 328-337 (1981).
- 11- Anonyme. HYDRA IV .Rapport COMEX (Marseille, 1984).
- 12- Ornhagen H., Adolfaon J., Gennser M., et al. Performance during hydrogen breathing at 13 atm. Undersea Biomed. Res. 11 (Suppl.) : 22-23 (1984).
- 13- Ornhagen H. Hydrogen-Oxygen (Hydrox) breathing at 1.3 MPa. FOA Rapport C58015-H1, National Defence research Institute, Department 5, S-102 54 Stockholm (1984).
- 14- Giry P., Hyacinthe R., Broussolle B., Battesti A. Physiologie respiratoire. In : ENTEX V Expérience de plongée profonde à 450 m. avec 12 jours de séjour au fond. Rapport final du contrat D.R.E.T./MARINE NATIONALE 80/1247 .VII-I-39 (1982).

- B 2 -

- 15- Hyacinthe R., Giry P., Battesti A. Mesures de physiologie respiratoire. In : ENTEX VIII : Expérience de plongée fictive profonde à 46 ATA (450 m) avec 12 jours de séjour au fond et travail en position immergée. Rapport final du contrat D.R.E.T./MARINE NATIONALE 81/1281. IV-1-43 (1984).
- 16- Giry P., Hyacinthe R., Battesti A. Mesures de physiologie respiratoire au cours de la plongée ENTEX IX. Rapport CERB N°83-16, CERB, BP 610, 83 800 Toulon-Naval (France).
- 17- Lind F.G., Truvé A.B. and Lindborg B.P.O. Microcomputer-assisted on-line measurement of breathing pattern and occlusion pressure. J. Appl. Physiol.: Respirat. Environ. Exercise Physiol. 56 : 235-239 (1984)
- 18- Maio D.A., Farhi L.E. Effect of gas density on mechanics of breathing. J. Appl. Physiol. 23 (5) : 687-693 (1967).
- 19- Vail E.G. Hyperbaric respiratory mechanics. Aerospace Med. 42 (5) : 536-546 (1971).
- 20- Miller J.N., Wangensteen O.D., Lanphier E.H. Ventilatory limitations on exertion at depth. In : Underwater Physiology. Proceedings of the Fourth Symposium on Underwater Physiology. Lambertsen C.J.(ed). New York : Academic Press : 317-323 (1971).
- 21- Uhl R.R., Van Dyke C., Cook R.B. et al. Effects of externally imposed mechanical resistances on breathing dense gas at exercise : mechanics of breathing. Aerospace Med. 43 (8) : 836-841 (1972).
- 22- Varène P., Vieillefond H., Lemaire Ch., Saumon G. Expiratory flow volume curves and ventilatory limitation of muscular exercise at depth. Aerospace Med. 45 (2) : 161-166 (1974).
- 23- Van Liew H.D. Mechanical and physical factors in lung function during work in dense environments. Undersea Biomed. Res. 10 (3) : 255-264 (1983).
- 24- Hyacinthe R., Giry P., Battesti A. Evolution des paramètres ventilatoires de la VMM en hyperbarie. Med. Sub. Hyp. 1 (3) : 111-118 (1982).
- 25- Dahlback G.O., Warkander D., Ornhagen H. Lung function during Hydrox breathing at 1.3 MPa. In : Ornhagen H. (ed.), Hydrogen-Oxygen (Hydrox) breathing at 1.3 MPa, op cit.
- 26- Dougherty J.H. Use of H2 as an inert gas during diving : pulmonary function during H2-O2 breathing at 7.06 ATA. Aviat. Space Environ. Med., 47 (6) : 618-626 (1976).
- 27- Kent D.W., Halsey M.J. and Eger II E.I. Pharmacological effects of helium, neon, hydrogen and nitrous oxide. In : Lambertsen C.J. (ed.), Underwater Physiology V, FASEB, Bethesda, Maryland : 581-586 (1976).
- 28- Varène P., Valiron M.O. Effets biologiques des gaz inertes. Bull. Europ. Physiopath. Resp. 16 : 79-109 (1980).
- 29- Friess S.L., Hudak W.V. and Boyer R.D. Toxicology of Hydrogen-containing Diving Environments. I. Antagonism of acute CO2 Effects in the Rat by Elevated Partial Pressures of H2 Gas. Toxicol. Appl. Pharmacol. 46 : 717-725 (1978).

« THIS DOCUMENT IS THE PROPERTY OF COMEX, all information contained herein may neither be reproduced, used, disclosed, transmitted nor in any way made public without the written permission of the owner, any person in possession of this document acknowledges being bound by the obligation to treat it as confidential. »

HYDRA V

CARDIOVASCULAR STUDIES

E.T. FLYNN, US NAVY

« THIS DOCUMENT IS THE PROPERTY OF COMEX, all information contained herein may neither be reproduced, used, disclosed, transmitted nor in any way made public without the written permission of the owner. any person in possession of this document acknowledges being bound by the obligation to treat it as confidential».

CARDIOVASCULAR STUDIES DURING HYDRA V

Participants

U.S. Navy:

E. Flynn (principal investigator)
T. Doubt
M. Ackerman
R. Banvard

Marine Nationale:

P. Giry
A. Battesti

G.I.S. Physiologie Hyperbare (CNRS):

G. Imbert
A. Folco

INTRODUCTION

The usefulness of hydrogen as a gas for deep diving will depend not only on its effects on the central nervous system but also on its effects on the cardiovascular system. If serious cardiac arrhythmias develop, or the heart fails to pump adequately during exercise, the beneficial effects of hydrogen on CNS and respiratory function would become largely academic. Although some animal data exists bearing on the question of cardiovascular function in high pressure hydrogen, only one human study, HYDRA IV, has been conducted. The present dive, HYDRA V, afforded the opportunity to extend these human observations not only at a higher absolute pressure, but for a longer duration of exposure.

METHODS

Studies in the dry were conducted in conjunction with the French Navy (Marine Nationale). Studies in the wet were performed with the G.I.S. Physiologie Hyperbare (CNRS). The conditions of the experiments are described in detail in the respective reports of these two groups.

Dry Studies

For the dry studies, pairs of 1 cm wide aluminized MYLAR strip electrodes were placed circumferentially around the neck and around the lower thorax. A 4 mA current at 100 kHz was applied to the outer neck and thoracic electrodes. The inner neck and thoracic electrodes recorded the changing thoracic impedance from which cardiac stroke volume was determined. EKG was obtained from patch electrodes placed on the thorax.

Briefly, the protocol called for a five minute period of absolute rest, followed by two six minute periods of work at moderate and heavy intensities. The subjects breathed either normally (R=0) or through an orifice resistor of progressively decreasing caliber (R=2 and R=3). The subject rested between the work periods for a variable period of time while gas analysis was performed and for a minimum of five minutes after the second workload.

For the measurement of thoracic impedance, the subject was instructed to stop work and to hold his breath at the end of a normal expiration. In this way, both the motion artifact of work and the respiratory variation in thoracic impedance were eliminated. All measurements were completed within 10 seconds of stopping work.

From the impedance wave form, cardiac stroke volume was derived using the following equation:

$$SV = A L \Delta Z / Z_0$$

where: SV = stroke volume in ml
 A = the area of the thorax derived from the circumference of the inner thoracic electrode
 L = mean distance between inner thoracic and inner neck electrodes
 ΔZ = the change in thoracic impedance with each cardiac stroke
 Z_0 = mean baseline thoracic impedance

Heart rate corresponding to each stroke volume was obtained from the frequency of the impedance traces. Heart rate was then multiplied by stroke volume to derive cardiac output.

The heart rate corresponding to each rest or exercise sequence was also determined by counting for the last minute of each session. These are the values shown in the subsequent tables.

Monoexponential functions were fit to the rise in heart rate with exercise and its subsequent fall with rest. From these functions the time constants of rise (τ_{on}) and fall (τ_{off}) were determined.

Wet Studies

For the wet studies, EKG was derived from the output of disc electrodes placed on the chest. Briefly, the experimental protocol consisted of having the diver rest or perform work by pulling a 10 or 15 kg weight through a distance of 0.4 m twenty-five times per minute. During one 15 kg work session, the diver increased the breathing resistance of the rig to a level which was just tolerable. Analysis of the data was limited to measurement of heart rate during rest or exercise once a steady state had been reached.

RESULTS

Dry Studies

The results of the heart rate and cardiac output measurements are shown in Tables 1 and 2 and in Figures 1 and 2. The A-team and B-team will be considered separately because of the differences in response.

The A-Team was able to complete all assigned workloads except for the heaviest workload with R=2 in heliox at 450 m. Preliminary analysis of the data showed no clear effects of resistance so all resistance conditions were lumped to illustrate effects of gas mixture and depth. The results appear in Figure 1. Both heart rate and cardiac output increased monotonically with exercise as expected. Both values were slightly higher with hydrox at 450 m when compared to heliox at 10 m. Heart rate and cardiac output were highest with heliox at 450 m. Some data was unacceptable for analysis particularly at the highest workloads, but these omissions were relatively few. Statistical analysis of the data has not yet been conducted.

The B-Team's heart rate response to exercise at 10 m heliox was nearly identical to the A-Team's, indicating that both groups were relatively evenly matched. At 450 m hydrox, only one subject (B1) performed at the level of the A-Team. Subject B2 performed a low level of exercise and subject B3 was unable to perform at all. Resting heart rate was elevated in B-Team in 450 m hydrox when compared to the 10 m heliox control. This is in contrast to the slightly lower values seen in 450 m hydrox in A-Team. The data contained more technically unsatisfactory traces than A-Team and coupled with the fewer conditions available for study limited the conclusions that could be drawn about the heart rate and cardiac output responses to exercise. As shown in Figure 2, however, it appeared that the performance of a given level of exercise at 450 m hydrox required a substantially higher heart rate and cardiac output. Statistical analysis of the data has not yet been conducted.

Both A- and B-Team members showed a normal supraventricular rhythm on EKG under all conditions tested. For the most part, this was clearly distinguishable as a normal sinus rhythm. In some tracings, the P wave was not apparent. These tracings may have been sinus or nodal in origin. The QRS duration appeared normal. A marked respiratory arrhythmia (sinus arrhythmia) was noted in all subjects under all conditions. Isolated premature supraventricular or ventricular beats were noted in some subjects at rest or in the resting period following work when the heart rate had slowed. Some isolated premature contractions were also noted during work at depth. The conditions under which premature beats appeared during work are shown in Table 3. No dangerous arrhythmias were noted at any time.

Time constants for the rate of rise and fall in heart rate with heavy exercise in A-Team without added respiratory resistance ($R=0$) are shown in Table 4. Other conditions have not yet been analyzed. Compression to 450 m slowed both the rate of rise and fall of heart rate. Hydrox appeared to have a faster rise than heliox at depth. The off time constants, however, were identical. Statistical analysis of the data has not yet been conducted.

Wet Studies

The heart rates observed during the wet studies are shown in Table 5. The imposed work load was mild relative to the workload used in the dry. The heart rates averaged 90-120. For technical reasons the tracings were difficult to analyze and data collection incomplete. In those tracings suitable for analysis, no arrhythmias were seen.

CONCLUSIONS

The A-Team was capable of performing very hard work in hydrox at 450 m. The increases in heart rate and cardiac output with exercise were appropriate to the work load and no significant arrhythmias appeared. The absolute values of heart rate and cardiac output were slightly lower on hydrox at 450 m than on heliox at the same depth and the rate of rise of heart rate with exercise was slightly faster with hydrox. Hydrox values at depth appeared closer to baseline values (10 m on heliox) than did the heliox values at depth. However, these differences were minor and may not stand up to statistical scrutiny.

The B-Team behaved differently at 450 m on hydrox than did the A-Team. The reasons for these differences are unclear. Also, heliox measurements at 450 m were not available for comparison with hydrox at depth. Only one member of B-Team was capable of doing hard work. Both at rest and for a given workload, heart rate and cardiac output in B-Team appeared substantially higher on hydrox at 450 m than on heliox at 10 m. These changes were out of proportion to those seen in the A-Team. No significant cardiac arrhythmias appeared.

All members of B-Team were able to perform exercise in the wet environment in full diving gear. The workloads, however, were mild relative to the dry, and thus did not allow us to test limits of the divers' exercise capability.

Condition	Subject	R = 0			R = 2			R = 3			
		Work Load	HR	Q	Work Load	HR	Q	Work Load	HR	Q	
10 m heliox	A1	0	68	6.68	0	84	7.40	0	70	7.68	
		105	86	11.00	105	97	11.49	105	94	14.37	
		154	104	13.05	210	135	15.15	210	126	18.24	
		210	120	15.36							
	A2	0	53	7.74	0	64	7.90	0	61	7.68	
		105	83	11.49	105	94	13.13	105	86	13.89	
		154	100	11.79	210	142	*	210	133	15.80	
		210	139	12.76							
	A3	0	82	7.44	0	78	5.31	0	75	6.80	
		105	103	10.51	105	112	7.51	105	113	7.31	
		210	137	11.13	210	149	*	210	153	*	
450 m heliox	A1	0	71	6.98	0	86	8.05	0	80	8.15	
		75	87	11.12	75	101	12.46	75	97	11.72	
		150	131	17.22	150	141	Note 1	110	124	16.00	
	A2	0	77	7.82	0	74	8.09	0	82	7.49	
		75	91	13.88	75	101	*	75	102	12.82	
		150	151	*	150	Note 2		110	123	*	
	A3	0	79	6.02	0	84	8.30	0	72	6.42	
		75	92	9.13	75	110	12.01	75	96	11.94	
		150	131	*	110	128	*	110	117	*	
	450 m hydrox	A1	0	69	6.48	0	84	7.40	0	62	6.27
			105	94	12.98	105	97	11.49	105	95	14.33
			210	130	17.59	210	135	15.15	154	121	16.30
A2		0	67	8.00	0	67	7.91	0	65	7.94	
		105	104	15.43	105	108	12.87	105	101	14.85	
		210	152	19.53	210	148	18.11	154	142	19.00	
A3		0	67	6.34	0	64	4.55	0	63	4.00	
		105	102	7.92	105	99	8.15	105	102	10.45	
		210	143	15.06	210	156	*	154	135	*	

TABLE 1. Cardiovascular Responses of A-Team

Work load in watts; HR = Heart Rate in beats/min; Q = cardiac output in L/min;
 * indicates data unsatisfactory for analysis; Note 1 - stopped work at 5 min 30 sec;
 Note 2 - stopped work at 1 min 58 sec.

Condition	Subject	R = 0			R = 2			R = 3		
		Work Load	HR	Q	Work Load	HR	Q	Work Load	HR	Q
10 m heliox	B1	0	66	8.42	0	65	8.30	0	62	8.65
		75	86	13.11	75	85	13.01	75	79	10.75
		150	119	14.65	150	122	15.12	150	110	15.68
	B2	0	83	6.05	0	89	6.19	0	99	7.86
		75	99	11.11	75	97	10.70	75	101	9.42
		150	127	17.27	150	140	17.61	150	141	13.49
	B3	0	46	5.38	0	56	6.48	0	50	6.79
		75	67	7.89	75	75	10.09	75	67	7.42
		150	98	13.79	150	109	15.24	150	97	12.70
450 m hydrox	B1	0	87	7.10	0	78	7.25	0	85	7.88
		105	126	*	105	110	12.99	105	131	15.33
		210	160	*	210	144	*	154	148	*
	B2	0	101	7.02	0	88	6.68	0	-	-
		105	140	14.12	105	150	*	105	-	-
		105	163	20.05						
		210	-	-	210	-	-	154	-	-
	B3	0	96	9.92	0	-	-	0	-	-
		105	Note 1		105	-	-	105	-	-
		210	-	-	210	-	-	154	-	-

TABLE 2. Cardiovascular Responses of B-Team

Work load in watts; HR = Heart Rate in beats/min; Q = cardiac output in L/min; - indicates experiment was not performed; * indicates data unsatisfactory for analysis; Note 1 - stopped work at 1 min 50 sec; Subject B2 performed the 105 W workload twice at 450 m, R=0.

<u>Subject</u>	<u>Depth</u> (m)	<u>Gas</u>	<u>Resistance</u> <u>Condition</u>	<u>Workload</u> (W)	<u>Arrhythmia</u>	
					<u>Type</u>	<u>Number</u>
A1	450	Hydrox	3	154	VPC VPC couplet	2 1
A1	450	Heliox	2	150	VPC	3
A3	450	Hydrox	2	105 210	VPC VPC couplet VPC	2 1 1
A3	450	Heliox	3	75	SVPC	2
B2	450	Hydrox	0	105	VPC	1

TABLE 3. Conditions under which cardiac arrhythmias appeared during exercise. VPC = ventricular premature contraction; SVPC = supraventricular premature contraction; VPC couplet = 2 ventricular premature contractions in a row.

<u>Subject</u>	<u>10 m heliox</u>		<u>450 m heliox</u>		<u>450 m hydrox</u>	
	<u>τ_{on}</u>	<u>τ_{off}</u>	<u>τ_{on}</u>	<u>τ_{off}</u>	<u>τ_{on}</u>	<u>τ_{off}</u>
A1	0.86	0.54	2.20	0.85	1.24	1.32
A2	0.53	0.73	0.65	1.09	0.95	0.76
A3	0.96	0.73	1.36	1.40	1.29	1.22
Mean	0.78	0.67	1.40	1.11	1.16	1.10
SEM	0.13	0.06	0.44	0.16	0.11	0.17

TABLE 4. Time constants (min) for rise of heart rate with heavy exercise and subsequent fall with rest. A-Team, no added respiratory resistance.

<u>Subject</u>	Workload				
	0	10 kg	15 kg no resistance	15 kg resistance	15 kg no resistance
B1	76	88	90	110	120
B2	77	91	96	96	97
B3	90	88	98	93	96

TABLE 5. Heart Rate Responses in B-Team to exercise in water at 450 breathing Hydrox. The workloads indicated were performed sequentially.

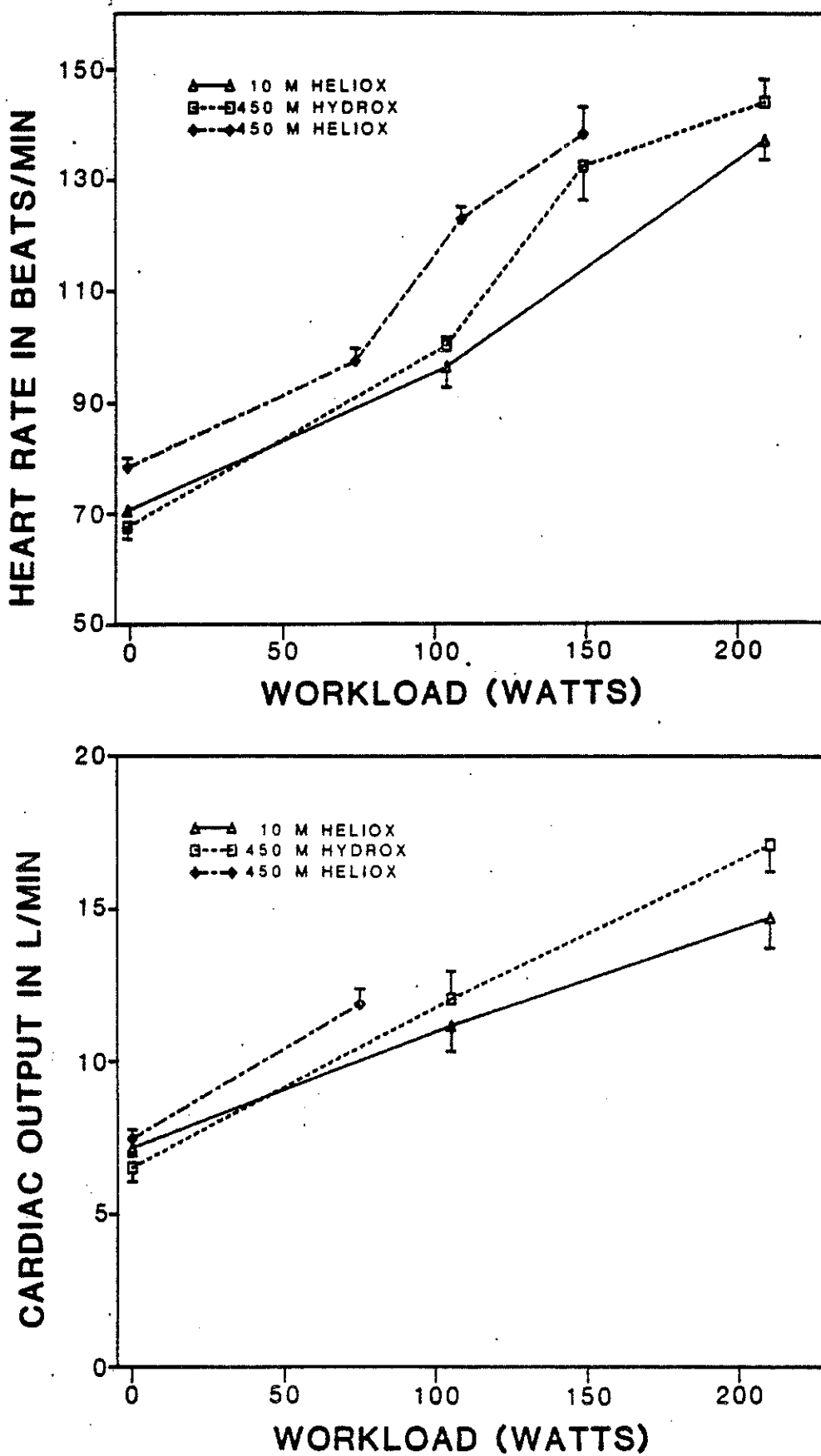

Figure 1. Cardiovascular responses to exercise in A-Team. All resistance conditions are included. Vertical bars indicate 1 standard error of the mean.

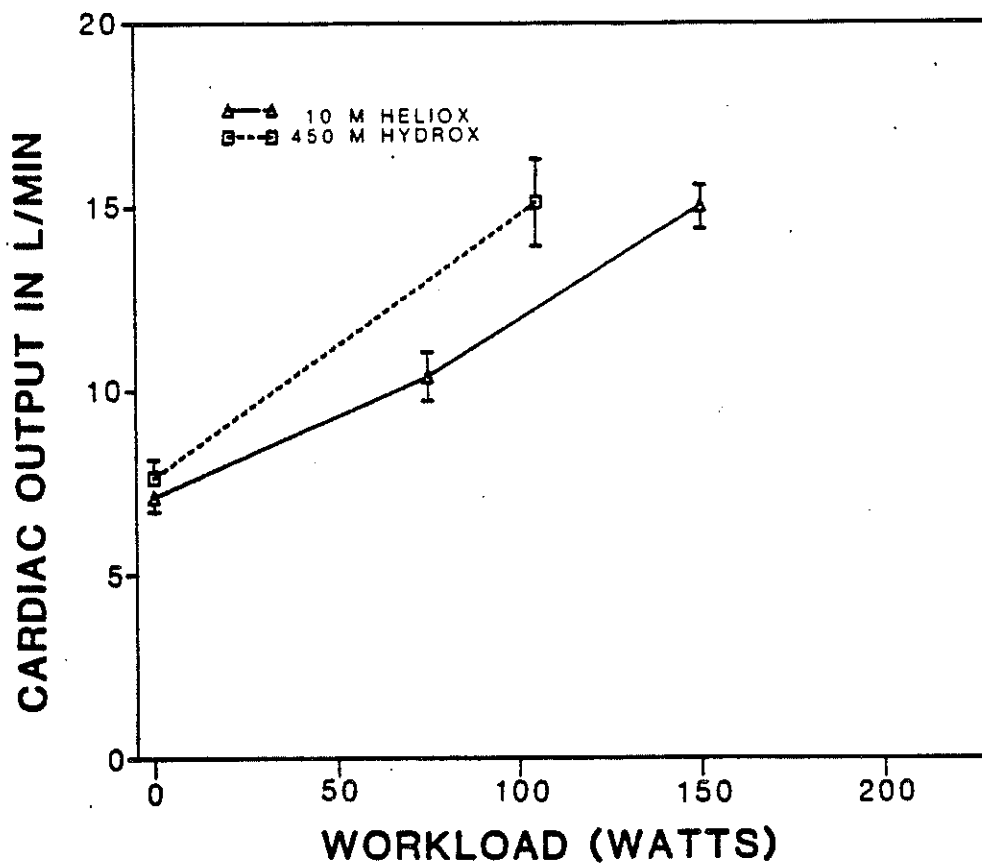
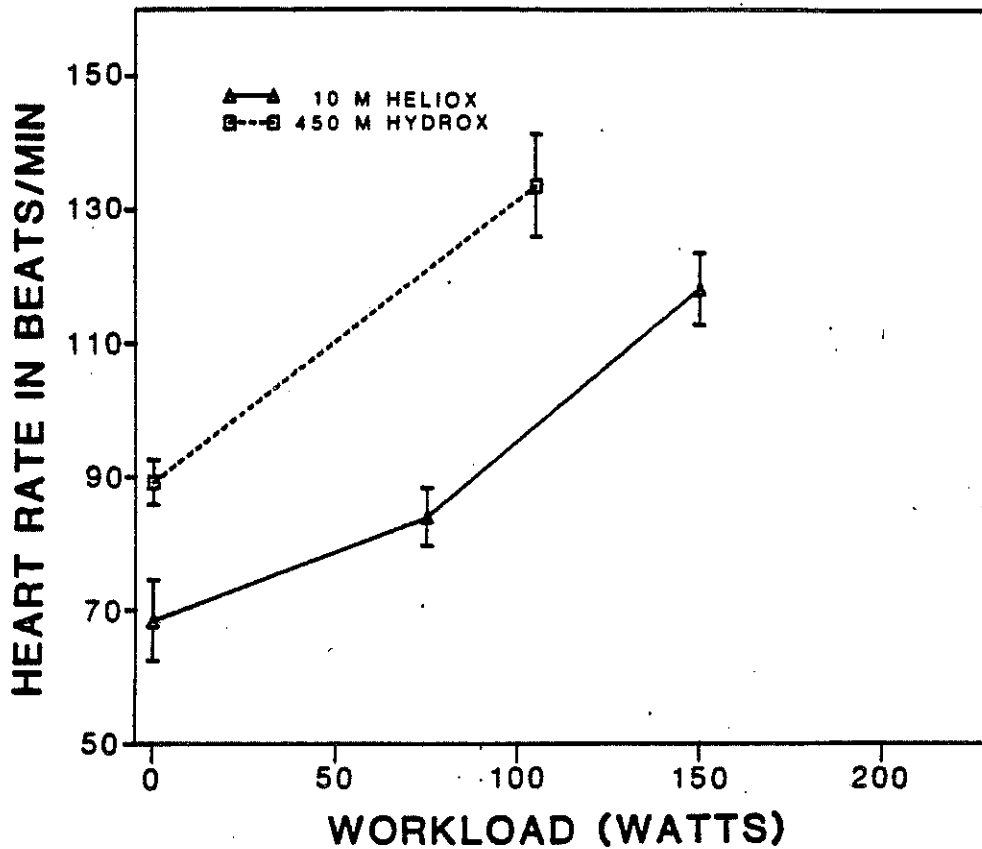

Figure 2. Cardiovascular responses to exercise in B-Team. All resistance conditions are included. Vertical bars indicate 1 standard error of the mean.

« THIS DOCUMENT IS THE PROPERTY OF COMEX, all information contained herein may neither be reproduced, used, disclosed, transmitted nor in any way made public without the written permission of the owner. any person in possession of this document acknowledges being bound by the obligation to treat it as confidential».

HYDRA V

RESPIRATORY STUDIES IN THE WET

G. IMBERT - COMEX, Marseille/GIS-CNRS, Marseille

RESPIRATORY STUDIES IN THE WET

G. Imbert (Comex, Marseille - GIS de Physiologie Hyperbare CNRS)
 A. Chattut (I.U.T. Marseille, Département de Mesures Physiques)
 A. Bénéd (Comex, Marseille)
 A. Folco (GIS de Physiologie Hyperbare CNRS, Marseille)
 M. Trovallet (Comex, Marseille)

M. Ackerman (NMRI, Bethesda, Hyperbaric Medicine Program Center)
 R. Banvard (NMRI, Bethesda, Hyperbaric Medicine Program Center)
 E. Flynn (NMRI, Bethesda, Hyperbaric Medicine Program Center)

P. Giry (CERB, Toulon, Service de Santé des Armées)

CONTENTS

1. OBJECTIVES

2. METHODS

2.1. Subjects

2.2. Instrumentation

- a) measuring devices
- b) data acquisition system

2.3. Procedures

2.4. Breathing mixture

3. RESULTS AND DISCUSSION

3.1. Bio-engineering data

- a) criticizable data
 - Magnetometry
 - Mass flowmetry
 - Mouth pressure
- b) positive data
 - Sampling techniques
 - Arm ergometer

3.2. Ergonomical data

- Diver B1
- Diver B2
- Diver B3

3.3 Physiological data

- a) pulmonary ventilation
- b) respiratory equivalent of oxygen
- c) oxygen consumption
- d) capnigraphical data

4. CONCLUSION

During the Hydra V experimental dive at Comex, a cooperative team C.N.R.S - U.S. NAVY (G.I.S. de Physiologie Hyperbare and Naval Medical Research Institute), was in charge of studying the respiration of a ternary hydrogen-helium-oxygen mixture (hydrox) in divers exercising underwater at 450 m simulated in a wet pot (*).

1. OBJECTIVES

Pulmonary function in deep dives meets conditions very different from breathing a natural atmosphere, and divers respiration may be hindered by several factors acting at the same time :

- high gas density of compressed respiratory mixtures ;
- effects of submersion on ventilatory mechanics ;
- external resistance of the underwater breathing apparatus ;
- newtonian thermal losses by ventilatory convection.

The experimental conditions in submersed studies are the closest possible to those that prevail in actual diving. Such studies are therefore very interesting. On the other hand, they are subjected to serious limitations with respect to the availability of physiological techniques. Hence, during Hydra 5 :

- the divers could not be asked to produce sustained efforts in order to determine the maximal power of exercise (as might be possible in tests carried out in a dry chamber at the same pressure) ;
- it was not possible to compare hydrox breathing to heliox breathing under the same conditions (as was done successfully during the Hydra 4 dive in 1983) ;
- only divers of team B were involved in the wet studies (team A divers were not switched back to hydrox, as primarily envisioned in the Hydra 5 program).

Therefore, the present studies were basically of an ergonomical nature. Our primary goal was to demonstrate that divers were able to produce breathing efforts equivalent to those usually required to match respiratory needs during underwater work (more than 25 liter/min), during long periods of time (2 hr minimum). The divers were equipped with a wet suit and a helmet connected to a demand valve. Sensors were fitted to this equipment, according to measurement needs. Apart from these sensors, the divers wore standard professional diving garments, such as those used on sea bed.

(*) with participation of the Centre d'Etudes et de Recherches Biologiques for mass spectrometry.

A few words about the nature of the exercise. As during the Entex 9 and Hydra 4 experiments, the Hydra 5 divers performed an underwater exercise on an arm ergometer. In our opinion, such an exercise simulates the efforts produced during underwater work, to a better extent than leg exercise on a bicycle ergometer. In the latter however more muscles are active, and thus a larger energy expenditure may be requested, reaching values close to the circulatory and respiratory limits of muscular activity, in a trained subject. Nevertheless, it is noteworthy that the level of arm exercise requested from the divers did increase pulmonary ventilation up to minute volumes greater than 25 liter/min (average value over 2 hr of measurement at 450 m), which was the expected result.

2. METHODS

2.1. Subjects

The three subjects of team B were :

- B1. Serge ICART
- B2. Yves LANGOUET
- B3. Jean-Pierre MACCHI

Table 1 presents their characteristics.

Table 1 : SUBJECTS' CHARACTERISTICS
(Team B)

	B1	B2	B3
Height (m)	1.76	1.78	1.72
Body mass (kg)	73	75	75
Age (yr)	32	39	34
Vital capacity (l BTPS)	5.67	5.83	4.84

2.2. Instrumentation.

Studies in the wet involved the following measurements :

Exercise movements :

- requested rythm (stroke/min)
- effective rythm (stroke/min)

Respiratory movements :

- of abdomen (mm)
- of chest (mm)
- frequency (breath/min)

Amounts related to time of :

- inspired gas (liter BTPS/min)
- consumed oxygen (liter STPD/min)

Instantaneous changes in :

- mouth pressure (mbar)
- breathed gas temperature (°C)
- CO₂ pressure in the breathed gas (Torr)
- cardiac rythm (beat/min)

We made use of sensors attached either to the diving garment or to the breathing circuitry (inspired and expired gases). The signals were fed to a computerized data acquisition system.

a) Measuring devices

Muscular movements

The diver was asked to perform 20 or 25 arm strokes per minute, according to a rythm set from the control panel. This needed the transmission of the rythm, and the monitoring of the effective working performed by the subject. The control system is presented in figure 1.

Breathing movements.

Changes in anteroposterior diameters of chest and of abdomen were detected using two pairs of magnetometer coils, according to the technique developed by the Naval Medical Research Institute. The sensors were waterproofed by a neoprene coating.

Inspired gas flow.

A mass flowmeter was incorporated in the supply line, at the intermediate pressure level. The sensor (Setaram U 70) was attached parallel to a horizontal and rectilinear tubing, which embodied a pressure drop system, especially matched to hydrox at this pressure. This segment was serially connected to a 20 liter buffer capacity and to a loop submersed in the wet pot water, in order to heat the inspired gas to the correct temperature (see figure 2). Note that pressures and temperatures in the gas tank were monitored continuously, in order to calculate the diver's overall consumption.

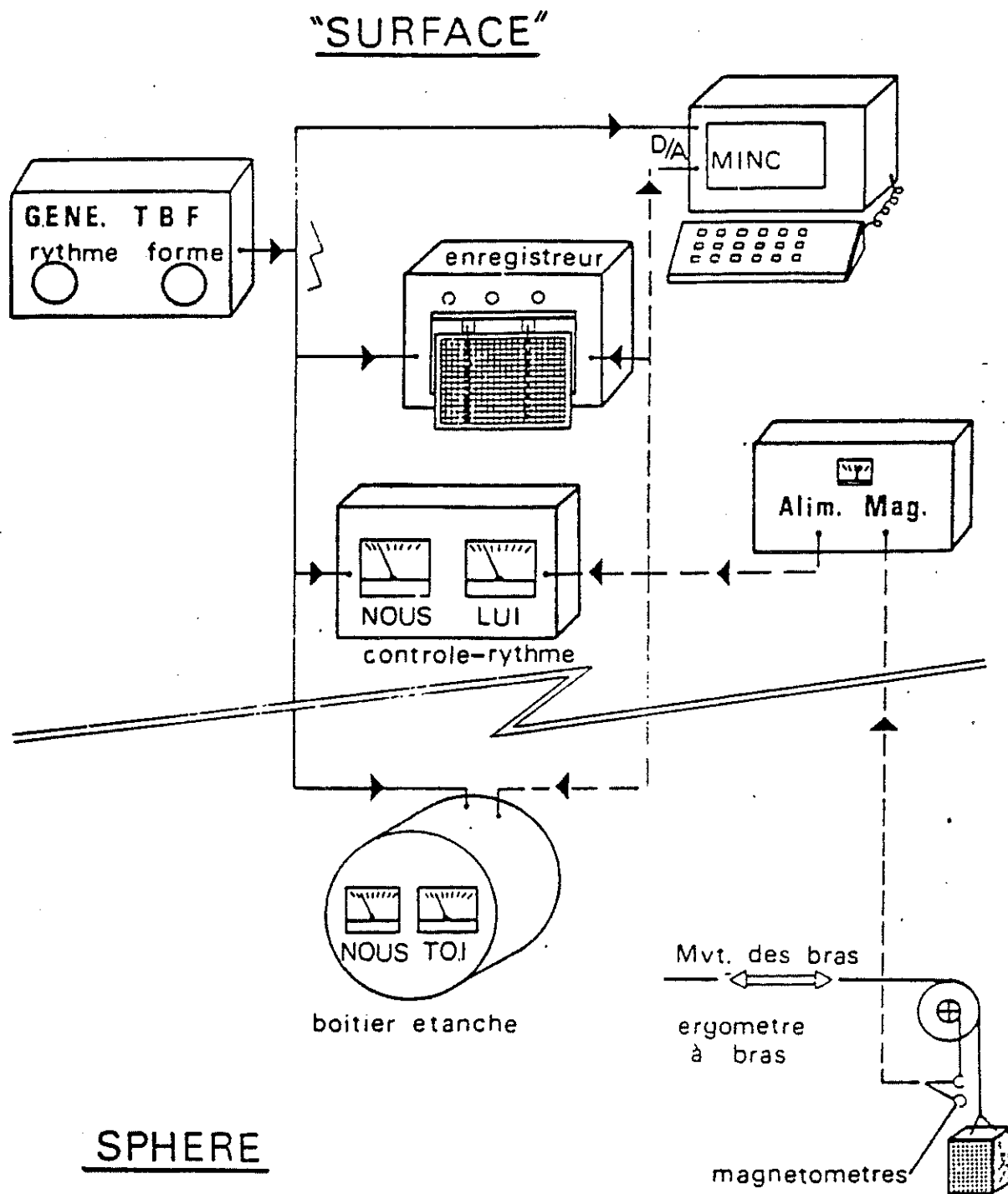

Figure 1. TRANSMISSION OF THE EXERCISE RYTHM TO THE DIVER AND THE MONITORING OF ITS EXECUTION

The rythm is set using a very low frequency generator, on which frequency is displayed in stroke/min. The shape is also assigned: the signal was triangular, with a longer time allowed for lifting than for lowering the weight. The diver is given the information by watching needle movements on the meter named "NOUS" (= us), in the waterproof container in front of him. Magnetometers attached to the ergometer enable the diver to control his own movements, which are translated by needle movements on the meter named "TOI" (= you). A recopy device is located at the control station, the second meter being named "LUI" (= he). The ideal execution would be to have both needles parallel at all times.

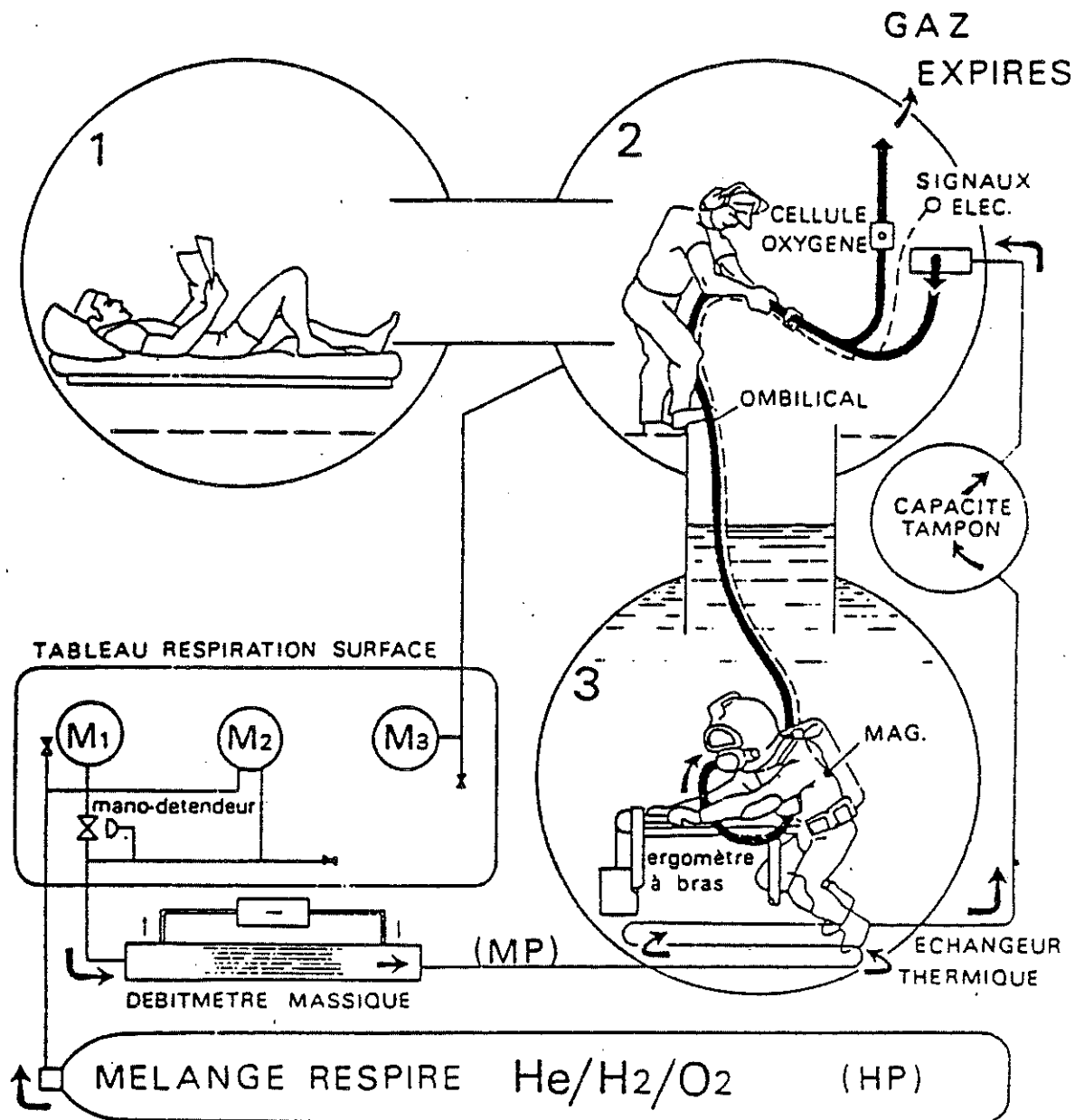

Figure 2. RESPIRATORY CIRCUITRY AND THE MEASUREMENT OF PULMONARY VENTILATION UNDER WET CONDITIONS.

Arrows show the circuit of the respiratory mixture from the high pressure cylinder, in which it was prepared, up to the free atmosphere, in which it will be finally evacuated. The cylinder pressure is read on the manometer M1. This enable us to measure the overall gas consumption, knowing the cylinder volume and gas temperature. After reduction to the intermediate pressure, the mixture flows through a pressure dropping device. A mass flowmeter is attached in parallel to the input and the output of this device. Then gas flows first through a loop submersed in the wet pot (to be heated at a comfortable temperature), then through a buffer tank, 20 liters in volume. It then reaches sphere 2, in which is connected the tether line that supplies the diver. The expired gas is collected through an exhaust line, which drives it back to sphere 2 where it is analyzed on line for O₂ its content (fuel cell). Finally it is directly exhausted in sphere 2, the pressure of which is maintained at 46 bar (that implies a constant exhaust of chamber gas equal to diver's ventilation).

Expired oxygen pressure.

Expired oxygen pressure was continuously monitored using a fuel cell (Sedam), placed in the expired gas flow, at exhaust level in sphere 2. A special mounting, embodying a 3 way valve enabled the bellman to switch temporarily from the expired gas to the inspired mixture, in order to obtain comparative data.

Capnigram

Carbon dioxide content in the expired gas was measured by mass spectrometry, an analysis performed by C.E.R.B. specialists. A minute gas flow was sampled in the diver's oronasal mask, and driven through the chamber wall to a mass spectrometer. The end-expiratory carbon dioxide fraction was assumed to represent that of the alveolar gas.

Mouth pressure.

As done in the Hydra 4 experiment a differential pressure sensor (range = 700 mbar) was attached horizontally at forehead level, inside the diver's helmet. But, in opposition to the Hydra 4 experiment, the reference chamber was open, and left in free communication with the helmet gas.

Mouth temperature.

A thermocouple was attached to the oronasal mask for sensing the flowing gas temperature.

Cardiac rythm.

Three EKG electrodes were attached to the diver's chest.

b) Data acquisition system

Analogic signals were recorded on paper chart, using two potentiometric multi-channel recorders (10 channels overall). This very simple and reliable method has however major drawbacks. Graphic recording corresponds to a very unpractical method of data storage, uneasy to process and very slow in access, compared to digital magnetic recording.

This is the reason why we have developed a data acquisition and processing system, embodying a Minc 11/23 computer, which was selected because it is specially designed for scientific experiments, because it can be easily moved from a site to another, and ordinarily used in most environmental conditions.

The software for Hydra 5 was developed by the Bio-engineering Branch of the Hyperbaric Medicine Program Center (program FRANCE written in FORTRAN) ; it allows :

1. To collect in parallel voltage signals (0 to 5 Volts), delivered by up to 10 different channels ;
2. To convert them to digital signals (0 to 2047 A.D. units for a voltage change from 0 to 5 V) ;
3. To display them graphically on a scope, each sequence corresponding to a 8 second sample for one channel at a time, and consisting in 240 successive discrete values.
4. To store them continuously on a floppy disk, in an unformatted binary code. The sampling frequency is 30 Hz (30 discrete values by channel and by second). This allows 10 channels to be recorded during 12 minutes on an 8-inch floppy disk (900 blocks), with still available space for record labelling, and calibration data.
5. To access to the stored data, by reading the floppy disk one channel at a time, and to convert them into an ASCII format. This format allows them to be processed using simple BASIC routines.

The processing routines (seek for extrema, amplitude or interval determination, averaging and variance computation) are flexible, written or modified at need, for each single signal, following the experimenter's various requirements.

2.3. Procedures.

Measurements under wet conditions at 450 meters, were carried out on 17 and 18 May 1985. Each diver stayed 2 hr underwater at a minimum, and performed 4 runs on the ergometer according to the following schedule :

- 1) 6 minutes, with a 10 kilogram load
- 2) 6 minutes, with a 15 kilogram load
- 3) 6 minutes, with 15 kilograms, with his U.B.A. set at the highestmost resistance tolerable threshold
- 4) a run prolonged after the 6th minute, for as long as possible, with a normal UBA setting.

All of these runs were recorded on floppy disks, together with the 2 minute-period of rest preceding exercise, and the 4-minute period following it (except for the last exercise, when prolonged beyond the 6th minute).

2.4. Breathing mixture.

The composition and characteristics of the ternary hydrox mixture breathed at 450 m is given in table 2. Reference values are also given for heliox and a trimix mixture at the same depth.

« THIS DOCUMENT IS THE PROPERTY OF COMEX, all information contained herein may neither be reproduced, used, disclosed, transmitted nor in any way made public without the written permission of the owner, any person in possession of this document acknowledges being bound by the obligation to treat it as confidential. »

Table 2 : GAS ABSOLUTE DENSITIES AT 450 m (BTFS)*

		Fractional concentrations					M	Z	Ctot	Absolute density!	Air equiv.
		O2	He	H2	M2	g/mol		mol/LBTFS	g/LBTFS	depth	
									± - incertitude		
HYDROX	54 % H2	0,009	0,441	0,540	0,000	3,17	1,024	1,743	5,56 ± 0,03	39 m	
HELIOX		0,009	0,991	0,000	0,000	4,25	1,021	1,748	7,46 ± 0,04	55 m	
TRIMIX		0,009	0,941	0,000	0,050	5,45	1,020	1,749	9,56 ± 0,04	74 m	

* PO₂ = 400 mbar

LEGEND : M = average molecular mass
 Z = compressibility factor (no dimension)
 Ctot = total molecular concentration

3. RESULTS AND DISCUSSION

The data have to be examined from 3 different standpoints :

- from the bio-engineering standpoint, i.e. the feasibility of recording valuable data from submersed divers ;
- from the ergonomical standpoint, i.e. the divers' performance at 450 m of simulated depth, breathing hydrox ;
- from the physiological standpoint, i.e. the analysis of biological variables which we were able to record.

3.1. Bio-engineering data

Physiological data must be recorded without encumbering the diver or hindering the normal use of the diving garment. The data from Hydra 5, as well as from Hydra 4, evidence the feasibility of such measurements, though some difficulties were encountered with the new techniques.

a) Criticizable results.

Magnetometry

Not only magnetometers were used for sensing respiratory movements, they allowed to monitor divers exercise on the arm ergometer. Waterproofing proved to be insufficient at 450 m, after a few hours of submersion under pressure. Coils have to be coated with a more water repellent material than neoprene rubber is, bee wax for instance. It appears also that repeating cycles of gaseous compression and decompression may accelerate water infiltration, because gas pockets tend to form that create water drains inside the magnetometer body.

Mass flowmeter.

A damped signal was expected from the mass flowmeter, with few oscillations at the breathing rythm, centered on a mean value which would correspond to an average flow, the quantity to be measured. In fact, we observed a biphasic signal, with a peak corresponding to inspiration, immediately followed by a negative wave, approximately equal in amplitude (figure 3). This signal may be reproduced with a ventilatory pump, if this pump is programmed for triangle-shaped cycles (i.e. input and output flows approximately constant). A triangle is assumed to be closer to the normal shape of a breath than the sinusoidal wave provided by most respiratory pumps. Finally, in order to process the recorded data, we were lead to calibrate the flowmeter for an assigned pattern (assumed to be similar to divers' breathing pattern), and for a given mixture (of the exact composition of the mixture that was breathed at 450 m). This procedure for measuring ventilation

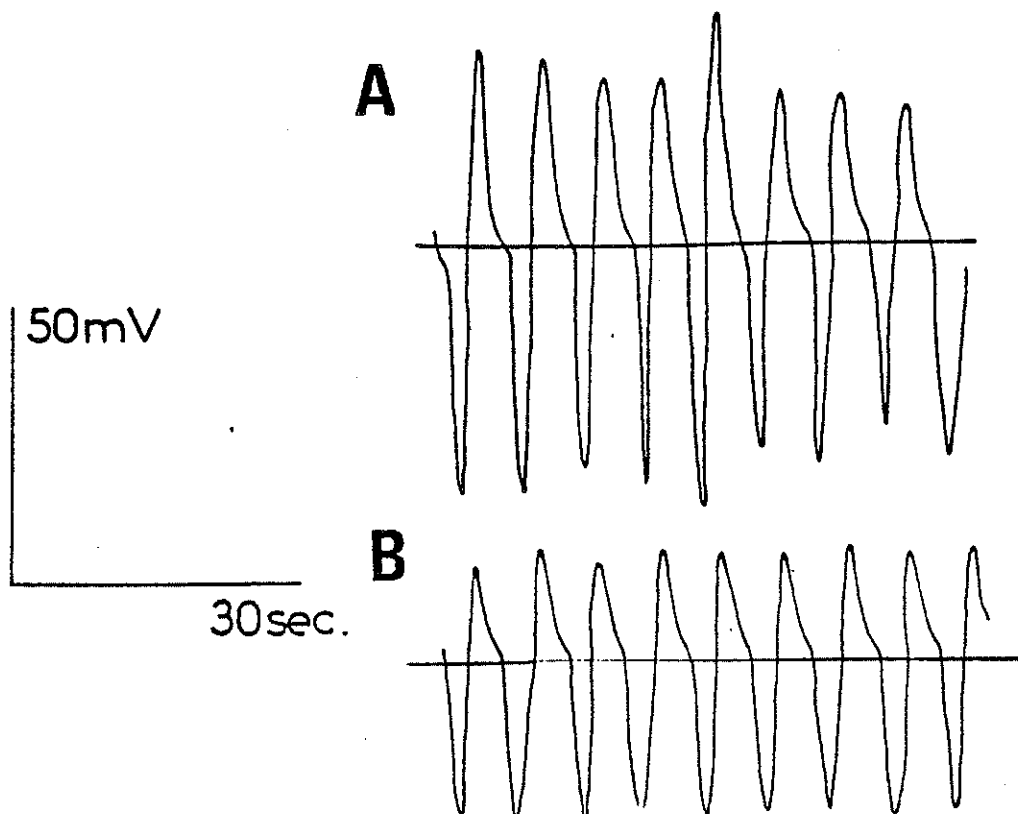

Figure 3 SIGNAL DERIVED FROM THE MASS FLOWMETER AT 46 BAR

Each sequence corresponds to 1 minute of recording (analogic plots on a potentiometric chart recorder).

- A. Diver B2 during the first exercise run.
- B. Record obtained with a respiratory pump (rate : 9 c/min, "tidal volume" = 1.85 liter, triangular shape).

(Note the negative wave which seems to indicate a back flow in the intermediate pressure circuitry)

is very inconvenient, costly and therefore hardly recommendable.

There is a remaining question about the biphasic shape of the signal accompanying each breath. The most probable hypothesis is a gas flowing back at the precise moment where inspiration stops, that is when the demand valve shuts. The observed phenomenon would be related to gas inertance, due to its increased density and lowered compressibility. The need for inserting buffering capacities in these circuitries, submitted to oscillating flows (such as surface loops for supplying divers at depth), appears to be another example of the importance of inertia related phenomena involved in gas transfer under pressure.

Mouth pressure.

In the Hydra 4 dive, the pressure sensor was used with its reference chamber closed. In the Hydra 5 dive, it was in free communication with the helmet gas. The first configuration was probably better, because mouth pressure recordings were not as good in Hydra 5 as they were in Hydra 4.

b) Positive data

Computerized acquisition techniques.

The reliability of computerized systems for recording physiological information is often questioned. But the system never failed during the Hydra 5 dive. Twelve floppy disks were recorded, and data were very rapidly processed, a few weeks, including the development of all BASIC routines. Chart recordings were used only for rapid data checking or iconographical purposes.

Arm ergometer

Displaying the exercise rythm on a analogic read out device allowed the divers to perform better than they did during the previous experiment, when communication difficulties were often encountered. However, the system major drawback is the inability to monitor the exercise power. It should be emphasized that divers did prefer exercising under wet than under dry conditions, which resulted in a beneficial effect on performance.

3.2. Ergonomical datas

All three divers performed the runs that were requested, whereas diver B2 and B3 encountered problems in exercising in the dry at the same pressure. The dive schedules of the dives in the wet pot at 450 m were as follows :

Diver B1 122 minutes.

May 17, 1985.

Water temperature : 34°C

15:05	start dive preparation
15:35	diver gets dressed
16:46	diver enters water
17:18	run on the arm ergometer (10 kg load)
17:24	stop exercising
17:47	run on the arm ergometer (15 kg load)
17:53	stop exercising
18:04	change in UBA setting (increased resistance)
18:12	run on the arm ergometer (15 kg load)
18:22	stop exercising, UBA returned to normal setting
18:25	run on the arm ergometer (15 kg load)
18:35	quit exercising
18:48	end of the dive

Overall duration of exercise on arm ergometer : 28 minutes.

Diver B2 122 minutes.

May 18, 1985.

Water temperature : 32°C

08:15 start dive preparation
 09:22 diver gets dressed
 09:48 diver enters water
 10:24 run on the arm ergometer (10 kg load)
 10:30 stop exercising
 10:49 run on the arm ergometer (15 kg load)
 10:55 stop exercising
 11:00 change in UBA setting (increased resistance)
 11:11 run on the arm ergometer (15 kg load)
 11:17 stop exercising, UBA returned to normal setting
 11:33 run on the arm ergometer (15 kg load)
 11:41 quit exercising
 11:50 end of the dive

Overall duration of exercise on arm ergometer : 25 minutes.

Diver B3 123 minutes.

May 18, 1985.

Water temperature : 31°C

15:10 start dive preparation
 15:52 diver gets dressed
 16:20 diver enters water
 16:43 run on the arm ergometer (10 kg load)
 16:49 stop exercising
 17:03 run on the arm ergometer (15 kg load)
 17:09 stop exercising
 17:18 change in UBA setting (increased resistance)
 17:42 run on the arm ergometer (15 kg load)
 17:48 stop exercising, UBA returned to normal setting
 17:58 run on the arm ergometer (15 kg load)
 18:11 quit exercising
 18:23 end of the dive

Overall duration of exercise on arm ergometer : 31 minutes.

Questionnaires were filled in by the divers after dive completion. They were asked about two specific aspects : exercise laboriousness, and reason for quitting the exercise in the last run (the diver was supposed to sustain it for as long as he wanted or felt capable).

a) exercise laboriousness

With a 10 kilogram load (to lift and lower over a height of 0.40 m, 25 times a minute), all divers reported the exercise as being "light".

With 15 kilogram (same exercise) B1 and B3 reported it as being "a little strenuous", and B2 as being "moderate".

b) reason for quitting

Breathlessness or dyspnea was never the reason for quitting the exercise in the last run. All divers reported to be far from reaching their ventilatory limits, as well as the U.B.A. maximal capability to supply gas with a reasonable breathing comfort. The reasons argued for quitting were arm or hand pain (B2, B3), or boredom (B1, B3). Finally the three subjects were satisfied with their underwater performance, and convinced that they had sufficiently evidenced their capability to exercise in such conditions.

3.3. Physiological results

a) pulmonary ventilation

Table 3 to 5 give the observed data :

Table 3 : PULMONARY VENTILATION DIVER B1

		1	2	3	4
Run	VE (l/min)	10.4	14.9	17.0	17.5
	VT (l)	2.3	2.4	2.2	2.5
Rest	fR (c/min)	4.5	6.2	7.7	6.9
	VE (l/min)	28.1	29.3	30.0	38.8
Exercise	VT (l)	2.3	2.7	3.0	2.7
	fR (c/min)	12.3	10.9	10.0	14.4

Table 4 : PULMONARY VENTILATION DIVER B2

		1	2	3	4
Run	VE (l/min)	18.5	14.2	13.8	14.1
	VT (l)	3.0	2.2	2.6	2.5
Rest	fR (c/min)	6.2	6.6	5.3	5.6
	VE (l/min)	27.7	31.7	31.0	31.5
Exercise	VT (l)	3.3	3.4	3.5	3.8
	fR (c/min)	8.3	9.3	8.9	8.3

Table 5 : PULMONARY VENTILATION DIVER B3

		1	2	3	4
Run	VE (l/min)	14.5	14.9	20.9	20.2
	VT (l)	2.3	2.3	2.5	2.5
Rest	fR (c/min)	6.2	6.4	8.4	8.1
	VE (l/min)	21.0	28.9	38.1	36.3
Exercise	VT (l)	2.5	3.0	3.1	3.1
	fR (c/min)	8.5	9.5	12.3	11.7

(*) 2 min average before exercising

(**) 4 min average. (3rd, 4th, 5th and last minutes of exercise)

b) respiratory equivalent of oxygen

It can be shown that :

$$ER_{O_2} = RT / \Delta P(I-E)_{O_2}$$

where ER_{O_2} is the respiratory equivalent of oxygen (l/mmol O_2)
 R the ideal gas constant (0.083 l.mbar/mmol.K)
 T the temperature in the lungs (310 K)
 $\Delta P(I-E)_{O_2}$ the oxygen pressure difference between the expired and the inspired gas (mbar)

The average values computed from $\Delta P(I-E)_{O_2}$ are :

B1 = 0.47 l/mmol O_2	(21 l BTPS/1 STPD O_2)
B2 = 0.44 l/mmol O_2	(20 l BTPS/1 STPD O_2)
B3 = 0.59 l/mmol O_2	(26 l BTPS/1 STPD O_2)

Observed values were not different at rest and exercise.

c) oxygen consumption

Values given in table 6 correspond to gross evaluations of the average oxygen consumption, obtained by dividing volume minute by the respiratory equivalent of oxygen :

Table 6 : OXYGEN CONSUMPTION ESTIMATIONS (l STPD/min)

	B1	B2	B3	Average
Average over 40 min	1.3	1.3	1.0	1.2
Minimal value (rest)	0.5	0.6	0.5	0.5
Maximal value (*)	2.3	1.9	1.6	1.9
Exercise with 10 kg	1.4	1.5	1.0	1.3

(*) over 2 minutes, from highest levels of ventilation

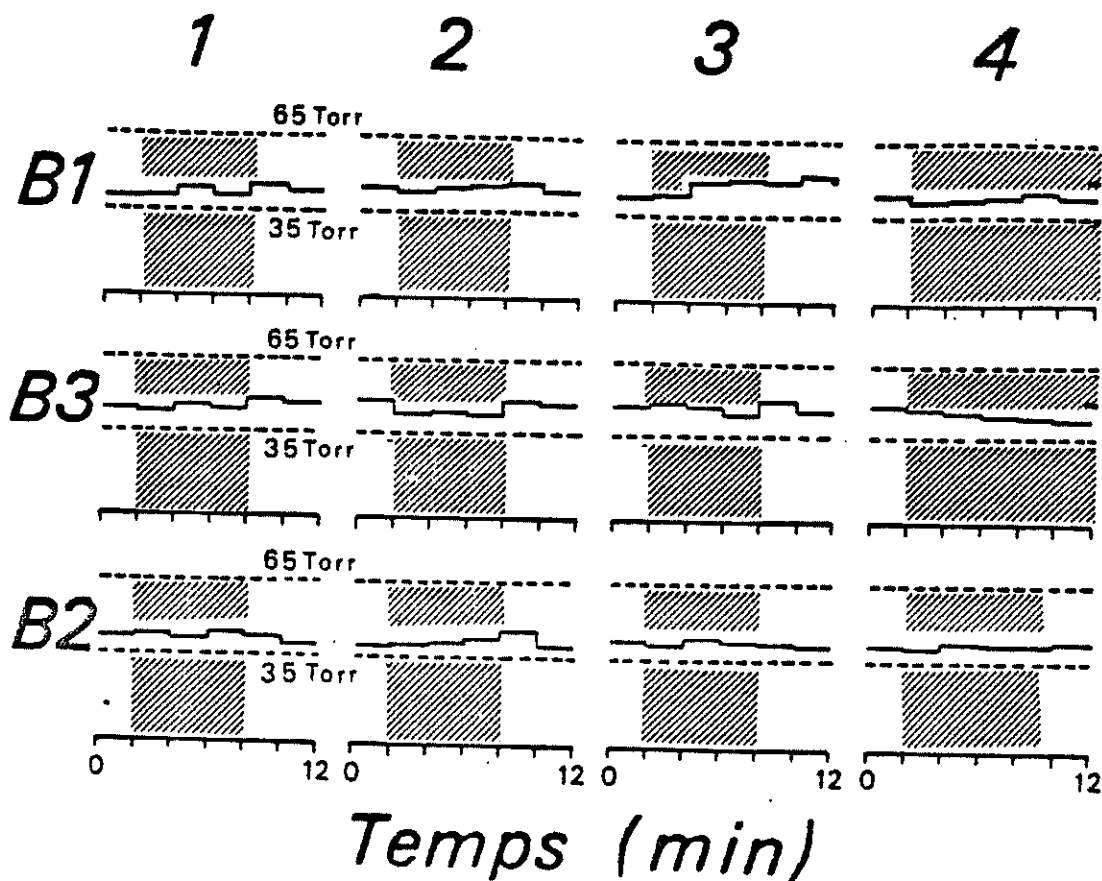

Figure 4 AVERAGE END-TIDAL CARBON DIOXIDE PRESSURE

The average value is given every two minutes, for all the measurements completed at 450 m, in the rank of execution of the runs, and for the three subjects : B1, B3 and B2.

The shaded area corresponds to the effective duration of the exercise on the arm ergometer (the last run is sustained for as long as the diver wants to or feels capable).

Observed values rarely were in excess of 50 Torr ; this seems to indicate that there was no carbon dioxide retention.

d) capnigramm

Figure 4 shows for all the measurements completed at 450 m the average end-tidal carbon dioxide pressure. Observed values were rarely in excess of 50 Torr ; this seems to indicate that there was no carbon dioxide retention during exercise.

4. CONCLUSION

During the Hydra 5 experiment, the respiratory measurements in submersed divers breathing hydrox could not be performed comparatively, as this was the case during Hydra 4, in which values for heliox at equal depths were available. This limits the conclusions which may be obtained from this experiment. However, we can make the four following points :

1°) Although some technical improvements are still needed, respiratory studies can be performed in the wet on divers wearing standard professional garments, without encumbrance or interference with the normal use of the U.B.A. The most difficult problem is to measure pulmonary ventilation, unless direct spirometry can be used (Hydra 4).

2°) Divers seem to exercise more voluntarily in wet than in dry conditions, with a subsequent improvement in performance. From the ergonomical standpoint, it must be emphasized that all divers of team B were able to stay 2 hours in water, to breath ternary hydrox at 450 m, and to produce important efforts with arms during 25 to 31 minutes. Average pulmonary ventilation during the time spent underwater was in excess of 25 l/min, i.e. corresponded to the average value commonly observed during underwater work. Given the same conditions for an underwater task on the sea bed (particularly thermal conditions), this suggests that these divers would have been able to develop an activity level equivalent to that normally requested.

3°) Physiological data, although fractional and uneasy to compare, seem to indicate that the divers never approached their ventilatory limits, with respect to the respiratory mixture, as well as to the breathing equipment. They reported that, subjectively, breathing hydrox is by far more comfortable than breathing heliox at the same depth. This is also evidenced by some measurements : the respiratory equivalent of O₂ was not reduced, and there was no sign of carbon dioxide retention, for exercise levels albeit relatively moderate.

4°) The pressure reversal effect of hydrogen narcosis was the most striking result obtained from the Hydra 5 experiment. This effect could be also evidenced from respiratory measurements in the wet. Effectively, the conditions that may be compared at the best to those of Hydra 5, with respect to hydrogen pressure, were those that prevailed at 240 m, breathing binary hydrox, during the Hydra 4 dive. The 6 divers were asked to perform a similar exercise on the same arm ergometer, but during 3 minutes only. With an hydrogen pressure of 24.5 bar, the ability to perform was considerably reduced by narcosis, and by the "respiratory depressant effect of hydrogen". During the Hydra 5 dive, with an hydrogen partial pressure of 24.8 bar, the 3 divers were able to perform the same exercise during 25 to 31 minutes (and at higher rate : 25 stroke/min instead of 15). Increased total pressure from 25 to 46 bar appears to be the major factor accounting for this striking improvement in divers' performance.

To our knowledge, the Hydra 5 experiment was the first opportunity to evidence in man a phenomenon which has been known for more than 30 years as the "pressure reversal effect", but which up to now has been observed only in animals.

HYDRA V DIVE

ULTRASONIC DETECTION OF CIRCULATING BUBBLES
COUNTERDIFFUSION PHENOMENON DATA
COMPARISON BETWEEN DECOMPRESSIONS WITH HELIOX AND HYDROX

MASUREL G. GUTIERREZ N

Centre d'Etudes et de Recherches Techniques Sous-Marines

D.C.A.N. 83800 TOULON-NAVAL

THIS DOCUMENT IS THE PROPERTY OF COMEX, all information contained herein may neither be reproduced, used, disclosed, transmitted nor in any way made public without the written permission of the owner. any person in possession of this document acknowledges being bound by the obligation to treat it as confidential.

S U M M A R Y

T E X T

Pages

1. - PURPOSES

2. - MATERIALS AND METHODS

 2.1 - Nature and conditions of hydrogen exposures

 2.2 - Divers

 2.3 - Bubble detectors

 2.4 - Methodology

3. - RESULTS AND DISCUSSION

 3.1 - Effects of gas switching

 3.2 - Decompression with heliox mixture

 3.3 - Decompression with hydrox

TABLE I to TABLE IV

FIGURE 1 to FIGURE 5

HYDRA V DIVE

ULTRASONIC DETECTION OF CIRCULATING BUBBLES
 COUNTERDIFFUSION PHENOMENON DATA
 COMPARISON BETWEEN DECOMPRESSIONS WITH HELIOX AND HYDROX

MASUREL G.* GUTIERREZ N*

1. - PURPOSES

As far as we are concerned the HYDRA V dive experimentation was organized with the purposes as follows :

- on the one hand, to verify some hypotheses based on results of previous experiments, namely that :
 - hydrogen is not toxic at the used partial pressure,
 - mixing hydrogen with a diluter may result in getting a higher threshold of narcosis, which allows to supply the divers with a mixture at 25 mbar without any noticeable narcotic effects,
 - hydrogen used at such pressures may have a real anti-HPNS power,
- and on the other hand to evaluate :
 - the increased ventilatory energy obtained at 450 msw with the hydrogenated mixture as compared with the heliox mixture (ENTEX IX) and the mixture containing 5 % nitrogen, dives : 79137, ENTEX V, ENTEX IX.
 - the importance of the counterdiffusion phenomenon when switching back to heliox before decompression.

A limited counterdiffusion would enable divers working at the bottom to use hydrox sequentially through a mangle. This would extend their operational limits without modifying the usual diving methods.

2. - MATERIALS AND METHODS

2.1 - Nature and conditions of hydrogen exposures

The initial experimental protocol specified that each diver group was to be exposed to hydrox to perform exercises in dry environment. When the A group of divers returned to heliox, then the B group was to be compressed and exposed to hydrox to do exercises in dry environment.

*Centre d'Etudes et de Recherches Techniques Sous-Marines
 D.C.A.N. 83800 TOULON-NAVAL
 Chemistry - Biology and Toxicology Department (MC GIACOMONI).

Then the diver groups shifted and the A group was returned to hydrox to carry out exercises under water while the B group returned to heliox for a limited period.

A second shift was planned as the A group of divers completed all the tests ; this group would then be returned to heliox in order to wait for the B group to complete the tests in hydrogen environment. Both groups then joined together in the final decompression with heliox.

Later on the course of events compelled us to modify this experimental protocol.

2.2 - Divers

It should be remembered that the A group of divers was composed of divers selected for their taking part in a previous experimental dive at 450 msw, and whose results could be taken as references. The 3 divers of the A group, were all quite experienced divers. The A1 diver had previously participated in a ENTEX V, the A2 diver in JANUS IV and ENTEX IX, the A3 diver in JANUS IV where he was a strong bubble producing subject. In Hydra IV this diver exhibited no bubbles at the end of a 6-hour exposure to hydrogen, whereas one of his fellow divers showed a high bubble grade after only 4 hours of exposure (ref. to 2006 CERTSM 84).

The B group comprised 3 divers of different origin :
 Diver B1 - although he was a deep diver - was performing his first experimental deep dive below 300 msw. Diver B2 had already performed deep dive (ENTEX V). As for diver B3 this was the first time he took part in an experimental deep dive.

2.3 - Bubble detectors

The bubble detectors used during the dive were our laboratory detectors of the DUG type, i.e. optimized prototypes. One such detector was placed in the life compartment, a second one in the transfer compartment, and a third one in the final decompression chamber.

It is worth noticing that the detectors' operation was modified neither by pressure nor by the presence of hydrogen. Only a considerable reduction in battery life was to be observed as compared with battery life during a similar experiment in helium environment.

As usual, the Doppler signals were systematically recorded in chronological order on magnetic tapes and cassettes, so as to group the results of each diver.

2.4 - Methodology

Each circulating bubble measurement sequences included as follows : a precordial detection, called detection "at rest" (R), in the standing subject after a few minutes' inactivity ; then a precordial detection "with movement" (M) during and following each one of three knee-bend movements separated by a one-minute time interval. Bubble grades were estimated according to the KM code (1).

The measurements also included bubble detection on each femoral vein and, whenever possible, at the level of the veina cava.

Sequential measurements were made during confinement and bottom stays, in order to make sure that the probe was operating properly and to keep the divers accustomed to the positions of the probes on each relevant site.

When switching from the 55 % hydrogen atmosphere to the 30 % hydrogen mixture, which occurred on Day 8 for the A group (i.e. after 90 hours of exposure to hydrox), a bubble detection was made immediately on the divers' arrival in chamber ② at 30 % from chamber ① at 55 % hydrogen. Measurements were then made every hour over a 5-hour period.

Likewise, as regards the switch from the 30 % mixture in chamber ② to the 0 % mixture in chamber ④, we applied to the A group the experimental protocol requiring a detection on the diver's arrival in the chamber and then every hour for the subsequent four hours.

We shall describe and account for protocol modifications when discussing experiment results.

In accordance with a now well-established protocol, three detections per day were planned during final decompression, namely one measurement in the morning on the subject's waking, one at 2 p.m. and one at 9 p.m.

- (1) KISMAN (K.E.), MASUREL (G.), GUILLERM (R.)
Bubble evaluation code for doppler ultrasonic decompression data.
Abstract published in Undersea Biomedical Research, supplement to vol. 5, N° 1, March 1978, page 28.

3. - RESULTS AND DISCUSSION

3.1 - Effects of gas switching

Results of the measurements made to determine the importance of the counterdiffusion phenomenon are listed in Tabel I and in Figure 1.

As we can see, the counterdiffusion remained quite moderate when switching from a 55 % to a 30 % hydrogen mixture. On the contrary, switching from the 30 % hydrogen mixture to the 0 % mixture eight hours later resulted in an immediate production of circulating bubbles. Within 3 Minutes after gas switchover, diver A2 exhibited grade 2+ bubbles at rest and grade 3 bubbles during movements, together with itching legs and torso. He simultaneously felt sick, dizzy and shivering as a probable result of the HPNS effect of helium. This diver also felt tired out.

In diver A1 such a phenomenon was tolerated better. As regards diver A3 he was not very much troubled. He only felt some itchings.

1 hour and 40 minutes after his return to heliox, diver A2 began to vomit. The divers were then supplied with a 2 % oxygen mixture through a mask. It was decided to recompress the divers to 460 msw.

After 1 hour of such oxygen breathing the symptoms had somewhat decreased.

He took off his respiratory mask that he could not wear any longer. Both of his knees and his right wrist were still aching.

2 hours and 40 minutes after return to heliox atmosphere diver A2 suffered bends in his knees and his left shoulder together with itching. He then resumed his breathing the 2 % oxygen mixture through a mask during 25 minutes. He also took 1 g of Aspirin.

As for diver A3, who known to be a bubble-producing subject during decompressions from saturation, he did no longer exhibit any symptoms.

5 hours and 30 minutes after return to heliox, divers A1 and A2 were made to breathe through a mask.

6 hour and 20 minutes after return to heliox atmosphere, the itching felt by A1 increased but they could still be endured if he stayed lying without any movement. Diver A2 also felt itchings ; articular pains had not decreased very much. The pressure was increased by 10 msw and the $PiCO_2$ was set at 600 mbar.

7 hours after return to heliox atmosphere, as the situation had not changed very much, it was decided to recompress the divers to 470 msw, and to break off the programme for a moment until the situation was clarified.

5 mg of Valium and 6 mg of Polaramine were successively prescribed to diver A2 for his itchings. Later on, this diver had to sleep in a seated position as it was the only position in which he could feel some relief.

The experimental programme was then modified on account of counterdiffusion effects observed in divers of the A group.

After return the heliox mixture chamber and compression to 470 msw the divers were allowed to rest for 12 hours at 470 msw. Afterwards, they were decompressed to 450 msw within 40 hours. Return to hydrogen was cancelled and it was decided to put off decompression until complete recovery of the divers. After three additional rest days at 450 msw the divers were decompressed after being exposed for one hour to a 600-mbar oxygen mixture supplied through a mask.

3.2 - Decompression with heliox mixture

It should be remembered that the decompression profile was a constant 45 min/m profile up to 15 msw from the surface and 60 min/m from 15 msw until surfacing with a $PiCO_2$ as follows :

600 mbar from 450 to 350 msw,
500 mbar from 350 to 120 msw,
600 mbar from 120 to 15 msw,
24 % between 15 and 0 msw.

Results of the circulating bubble ultrasonic detection performed during decompression are listed in Table II in Figures 2 and 3. It can be noted that the first bubbles occurred very early, at 425 msw, both in diver A2 who produced the greatest number of bubbles during the switch from hydrox to heliox, and in diver A3 who exhibited no bubbles at all during gas switching.

The bubble production remained quite low up to 280 msw, a depth at which bubbles occurred for the first time at rest. However, with one exception in diver A1 at 184 msw, the bubble grades at rest were never higher than grade 1, which is quite acceptable, even though the divers exhibited grade 3 bubbles during movements on several occasions between 295 and 38 msw. Diver A3 even produced grade 4- bubbles at 38 msw on one occasion : this bubble grade then decreased. Afterwards, A1 and A3 exhibited a slight bend at 1,3 msw from the surface. This bend was treated by recompressing the divers to 4 msw, supplying them with oxygen through a mask on three different occasions, and prescribing 1 tablet of Aspegic 1000.

3.3 - Decompression with hydrox

Even before counterdiffusion incidents occurred among the divers of the A group, it had already been decided to decompress the divers of the B group in a hydrox atmosphere, on account of their behaviour which was apparently free from any trouble in hydrox environment.

Subsequently, the advantage of decompressing the 2nd group in hydrox environment was confirmed by results obtained with the A group.

We had then to choose between two solutions as follows :

- either decompressing and gradually removing hydrogen to return to 200 msw in heliox atmosphere,
- or decompressing normally in hydrox atmosphere to 200 msw and then switching gases according to the same methods as at 450 msw.

It seemed to us that the first solution would probably be the least severe, although it would then be difficult to determine the respective parts taken by counterdiffusion and supersaturation in the possible formation of bubbles during the first part of decompression. In addition to this uncertainty it should be mentioned that the decompression methods to be used in hydrox environment are not well known yet. Everything considered, we selected to decompress in 2-msw decompression steps immediately followed by 1-msw recompression steps in helium environment, so as to gradually enrich the mixture with helium and to reduce the H_2 up to 2 % when arriving at 200 msw.

Decompression was started at a rate of 70 min/m, but in the absence of bubbles this rate was gradually increased as follows :

- up to 65 min/m from 350 msw,
- up to 60 min/m from 300 msw,
- up to 55 min/m from 250 to 15 msw.

For convenience' sake and not for the sake of necessity, the decompression rate was then reduced to 90 and 120 min/m between 15 msw and the surface (Figure 2).

The P_{iCO_2} was kept at 500 mbar between 450 and 100 msw, at 600 mbar from 100 to 15 msw, and then at 24 % up to the surface.

Results of the circulating bubble detection carried out during decompression are listed in Table III and in Figures 4 and 5.

When analyzing these data, it appears that bubbles occurred later in the B group than in the A group, that is at 282 msw in diver B1. Afterwards, a regular bubble flow was observed from 271 msw in diver B3 who never exhibited bubble grades higher than 1 at rest and 3 during movements. As for diver B2, he never produced any bubble.

On the whole, the 2nd decompression was tolerated better, and it might have been possible to increase its rate sooner. It seems that a decompression rate of 50 min/m would be a good compromise likely to ensure safe decompression with both gas mixtures. It would also have prevented A3 from suffering bends.

It is worth noticing that hydrogen decompression rates do not appear radically different from those of helium. A decompression rate of the same order for two gases as different as helium and hydrogen (see Table IV) would be a factor in favour of perfusion as a decompression limiting element.

HYDRA V DIVE

Subjects		A1		A2		A3	
Sequence	Hours	R	M	R	M	R	M
Recording after switching from the 55 % to the 30 % hydrox mixture	1/2 h	0	0	0	0	0	0
	1 h 40	0	0	0	0	0	0
	3 h	0	0	0	0	1 ⁻	0
	5 h	0	0	1	1	0	0
	7 h	0	0	0	0	0	0
Recording after switching from the 30 % to the 0 % hydrogenated mixture	10 h	0	0*	2 ⁺	3*	0	0
	1 h 20	1	2 ⁺	3 ⁺	3 ⁺	0	2
	3 h	0	0	2	MN	0	1
	5 h 15	0	0	2	3	0	1

* Divers exhausted and nauseated

MN : No measurement : diver exhausted (lying down)

Compression { to 460 msw at the beginning of the 5th hour } after return
 { to 470 msw at the beginning of the 7th hour } to heliox

TABLE I

RESULTS OF BUBBLE DETECTION AFTER SWITCHING
 FROM HYDROX TO HELIOX

THIS DOCUMENT IS THE PROPERTY OF COMEX, all information contained herein may neither be reproduced, used, disclosed, transmitted nor in any way made public without the written permission of the owner, any person in possession of this document acknowledges being bound by the obligation to treat it as confidential.

Days	Cumulated time (hours)	Depth (msw)	Detection (hours)	A1			A2			A3			Mean bubbles grade		
				R	M	FC	R	M	FC	R	M	FC	R	M	
May 17 14	246	439	08 h 00	0*	0	82	0	0	80	0	0	75	0	0	
	257	425	19 h 00	0	0	68	0	1	80	0	0	78	0	0.33	
May 18 15	269	407	07 h 15	0	0	88	0	1	82	0	1	92	0	0.67	
	281	392	19 h 15	0	0	78	0	0	86	0	2	80	0	0.67	
May 19 16	294	375	08 h 00	0	0	92	0	1	82	0	2	95	0	0.39	
	306	359	19 h 40	1	2	73	0	0	75	0	2*	84	0.33	1.44	
May 20 17	317.5	344	07 h 30	0	0	84	0	1	100	0	2	94	0	0.39	
	330	327	19 h 45	0	1*	75	0	2	68	0	2*	80	0	1.39	
May 21 18	341.5	312	07 h 30	1	0	96	0	0	104	0	2	92	0.22	0.67	
	354	295	19 h 45	0	0	90	0	1	78	0	3	84	0	1.44	
May 22 19	365.5	280	07 h 40	0	2	94	1	3	82	1	3*	94	0.67	2.78	
	371.5	270	13 h 25	0	1*	80	0	2	90	1	3	86	0.33	2.11	
	378	263	20 h 00	0	1*	85	1	2	76	1	3	84	0.67	2	
May 23 20	390	247	07 h 50	0	1*	94	0	2	88	0	3	95	0	2	
	396.5	238	14 h 35	0	1*	77	1	3	68	0	3	88	0.33	2.22	
	402	231	20 h 10	0	1	80	1	2	76	0	3	84	0.33	2.11	
May 24 21	413.5	216	07 h 37	0	2	92	0	2	92	1	2*	90	0.33	2.11	
	420.5	206	14 h 27	0	2	82	1	2	86	1	1	88	0.67	1.67	
	425.5	200	19 h 37	1	2*	84	0	2*	84	0	1	78	0.33	1.39	
May 25 22	437.5	184	07 h 33	3	3	96	0	3	94	1	3	94	1.22	3	
	444	175	13 h 45	0	2	82	1	3	94	1	1	80	0.67	1.77	
	450	167	20 h 00	1	3	78	1	2*	80	1	3	83	1	2.56	
May 26 23	462	150	07 h 45	1	2*	90	1	2*	86	0	3	84	0.67	2.55	
	467.5	144	13 h 30	0	1	84	0	3	78	0	2*	88	0	2.11	
	474	135	19 h 40	0	1	84	1	2*	74	1	3	88	0.67	2.22	
May 27 24	486	119	07 h 45	1*	3	88	1	3	80	0	3	90	0.78	2.89	
	492	112	13 h 55	0	2	78	0	2*	70	0	2	84	0	2.11	
	498	105	20 h 00	0	3	80	0	2	84	1	3	90	0.33	2.78	
May 28 25	509.5	88	07 h 35	0	2*	88	0	1	80	0	3	84	0	2.11	
	515.5	80	13 h 35	0	2	84	0	2	80	0	0	90	0	1.11	
	522	71	20 h 00	1	1	86	1	2	80	0	2*	80	0.44	1.39	
May 29 26	534	55	08 h 15	0	2	87	0	2*	80	0	1*	106	0	1.89	
	540	47	14 h 00	0	1*	86	1	3	85	0	2*	100	0.33	2.11	
	546	38	20 h 00	0	0	78	0	2*	78	1	4	96	0.33	2	
May 30 27	559	21.5	08 h 15	1	2*	92	0	2	98	0	2*	104	0.22	2.22	
	564	15	14 h 00	0	2	80	0	1	84	0	2	94	0	1.67	
	570	8	20 h 00	0	2	88	0	1	90	0	2*	94	0	1.66	
May 31 28	580	4	05 h 40	0	0	104	/	/	/	0	0	96	0	0	
	585	0.5	11 h 00	0	1*	94	0	0	124	0	0	108	0	0.44	
Mean (n = 37)							0.27	1.41	84.4	0.32	1.76	83	0.30	2.21	88.4
Severity Index							1.077	9.336		0.401	12.303		0.407	24.020	

TABLE II

THIS DOCUMENT IS THE PROPERTY OF COMEX, all information contained herein may neither be reproduced, used, disclosed, transmitted nor in any way made public without the written permission of the owner, any person in possession of this document acknowledges being bound by the obligation to treat it as confidential.

Days	Cham- Lates Time (hours)	Depth (meters)	Detec- tion (hours)	55'			52'			53'			Mean bubbles grader	
				R	M	FC	R	M	FC	R	M	FC	R	M
May 19 16	157	442	09 h 00	0	0	97	0	0	92	0	0	80	0	0
	162.5	437	14 h 30	0	0	82	0	0	90	0	0	84	0	0
	168.5	432	20 h 30	0	0	76	0	0	86	0	0	75	0	0
May 20 17	179	422	07 h 00	0	0	92	0	0	86	0	0	87	0	0
	186	416	14 h 00	0	0	82	0	0	88	0	0	75	0	0
	192.5	411	20 h 30	0	0	76	0	0	84	0	0	70	0	0
May 21 18	203	402	07 h 00	0	0	98	0	0	80	0	0	88	0	0
	210	396	14 h 00	0	0	76	0	0	90	0	0	70	0	0
	216	390	20 h 15	0	0	92	0	0	90	0	0	62	0	0
May 22 19	227	387	07 h 00	0	0	88	0	0	80	0	0	82	0	0
	234	376	14 h 00	0	0	80	0	0	86	0	0	72	0	0
	240.5	370	20 h 30	0	0	88	0	0	96	0	0	80	0	0
May 23 20	251	361	07 h 15	0	0	92	0	0	80	0	0	65	0	0
	258	355	14 h 15	0	0	92	0	0	107	0	0	67	0	0
	264	350	20 h 00	0	0	87	0	0	88	0	0	68	0	0
May 24 21	275	340	07 h 00	0	0	84	0	0	96	0	0	74	0	0
	282	333	14 h 00	0	0	88	0	0	98	0	0	70	0	0
	288	327	20 h 00	0	0	80	0	0	90	0	0	72	0	0
May 25 22	299	318	07 h 10	0	0	96	0	0	94	0	0	80	0	0
	306	311	14 h 15	0	0	84	0	0	98	0	0	70	0	0
	312.5	305	20 h 30	0	0	88	0	0	104	0	1"	78	0	0.22
May 26 23	323	295	07 h 15	0	0	90	0	0	90	0	0	69	0	0
	330	289	14 h 00	0	0	100	0	0	109	0	0	68	0	0
	336	282	20 h 15	0	2"	92	0	0	98	0	0	64	0	0.55
May 27 24	347	271	07 h 15	0	1	110	0	0	82	1	1"	74	0.33	0.78
	353.5	265	13 h 30	0	1	108	0	0	98	0	2"	76	0	1.11
	360.5	258	20 h 30	0	0	84	0	0	88	0	1"	72	0	0.34
May 28 25	371	247	07 h 15	0	1	108	0	0	90	1	2	92	0.33	1
	377	240	14 h 00	0	0	100	0	0	116	0	3"	84	0	0.39
	384.5	232	20 h 30	0	1	108	0	0	104	1"	2	84	0.22	1
May 29 26	395.5	221	07 h 30	0	1	111	0	0	88	1	2"	75	0.33	0.39
	403	212	14 h 45	0	1	108	0	0	104	1"	3"	95	0.34	1.22
	407.5	207	19 h 30	0	1	88	0	0	100	1	3"	82	0.33	1.22
May 30 27	419.5	194	07 h 30	0	0	102	0	0	102	1"	1	90	0.22	0.33
	426	187	14 h 00	0	1	103	0	0	96	0	3"	80	0	1.22
	432	180	20 h 00	0	1	88	0	0	106	1	2"	76	0.33	1.11
May 31 28	443	168	07 h 00	0	0	88	0	0	84	0	2"	74	0	0.78
	450	161	14 h 00	1	1"	92	0	0	96	1	3	86	0.67	1.33
	456	154	20 h 00	0	0	96	0	0	96	0	3"	84	0	0.39
June 1st 29	467	142	07 h 00	0	1	96	0	0	84	1	3	70	0.33	1.33
	474	135	14 h 00	0	0	105	0	0	110	0	3"	102	0	0.39
	480	128	20 h 00	0	1	100	0	0	105	1"	3"	93	0.22	1.22
June 2nd 30	491	116	07 h 15	0	0	112	0	0	100	1	3	78	0.33	1
	498	109	14 h 00	0	0	120	0	0	108	0	3	92	0	1
	504	102	20 h 00	0	0	92	0	0	100	0	3	88	0	1
June 3rd 31	515	90	07 h 00	0	0	98	0	0	90	0	3	84	0	1
	522	82	14 h 00	0	0	92	0	0	82	0	3	92	0	1
	528	76	20 h 15	0	0	96	0	0	92	1"	3	84	0.22	1
June 4th 1	539	63	07 h 00	0	1	98	0	0	94	1"	3"	74	0.22	1.34
	546	56	14 h 00	0	0	90	0	0	108	1	3"	90	0.33	0.39
	552	49	20 h 00	0	1	96	0	0	95	1"	3"	88	0.22	1.22
June 5th 3	563.5	36	07 h 30	0	0	90	0	0	98	1	3"	75	0.33	1.11
	570	29	14 h 00	0	0	84	0	0	100	1"	3	82	0.22	1
	576	22.7	20 h 00	0	0	78	0	0	98	0	3"	68	0	1.11
June 6th 4	588	13	07 h 45	0	0	90	0	0	100	0	4	98	0	1.33
	594	9.6	14 h 00	0	0	92	0	0	100	0	0	103	0	0
	600	6.5	20 h 15	0	0	86	0	0	104	0	0	99	0	0
June 7th 5	612	2.7	07 h 55	0	0	94	0	0	98	0	0	92	0	0
	618	Surface	14 h 00	0	0	120	0	0	132	0	0	122	0	0
Mean (n = 99)				0.017	0.271	93.5	0	0	95.8	0.27	1.39	80.5		
Severity Index				0.022	0.535		0	0		0.381	17.366			

TABLE III

Gas	Atomic weight	Ostwald' solubility coefficient at 37° C in ml/l			
		Water	Oil	Blood	Muscle
H ₂	2	18	49	18	17
He	4	10	17	10	12
N ₂	28	14	73	18	

Solubility of inert gases in biological fluids and tissues : a review.

WEATHERSBY P.K. HOMER L.D.

Undersea Biomedical Research 7 (4) 277-256 (1980).

NOTE : We choose for each case mean value from the referencies.

TABLEAU IV

THIS DOCUMENT IS THE PROPERTY OF COMEX, all information contained herein may neither be reproduced, used, disclosed, transmitted nor in any way made public without the written permission of the owner, any person in possession of this document acknowledges being bound by the obligation to treat it as confidential.

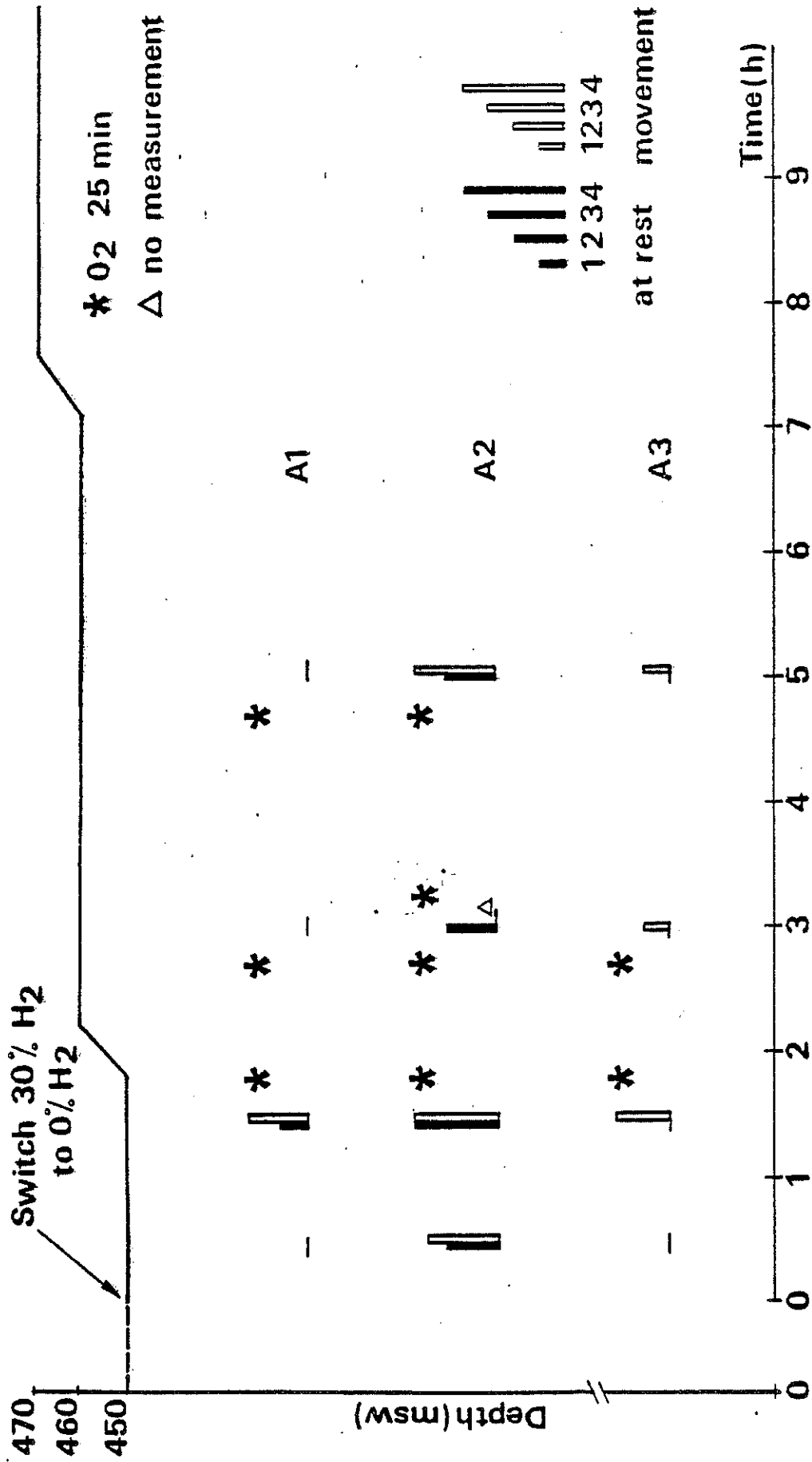

BUBBLE DETECTION RESULTS AFTER A SWITCH FROM HYDROX TO HELIOX : COUNTERDIFFUSION EFFECT DIVE HYDRA V

FIGURE 1

« THIS DOCUMENT IS THE PROPERTY OF COMEX, all information contained herein may neither be reproduced, used, disclosed, transmitted nor in any way made public without the written permission of the owner, any person in possession of this document acknowledges being bound by the obligation to treat it as confidential. »

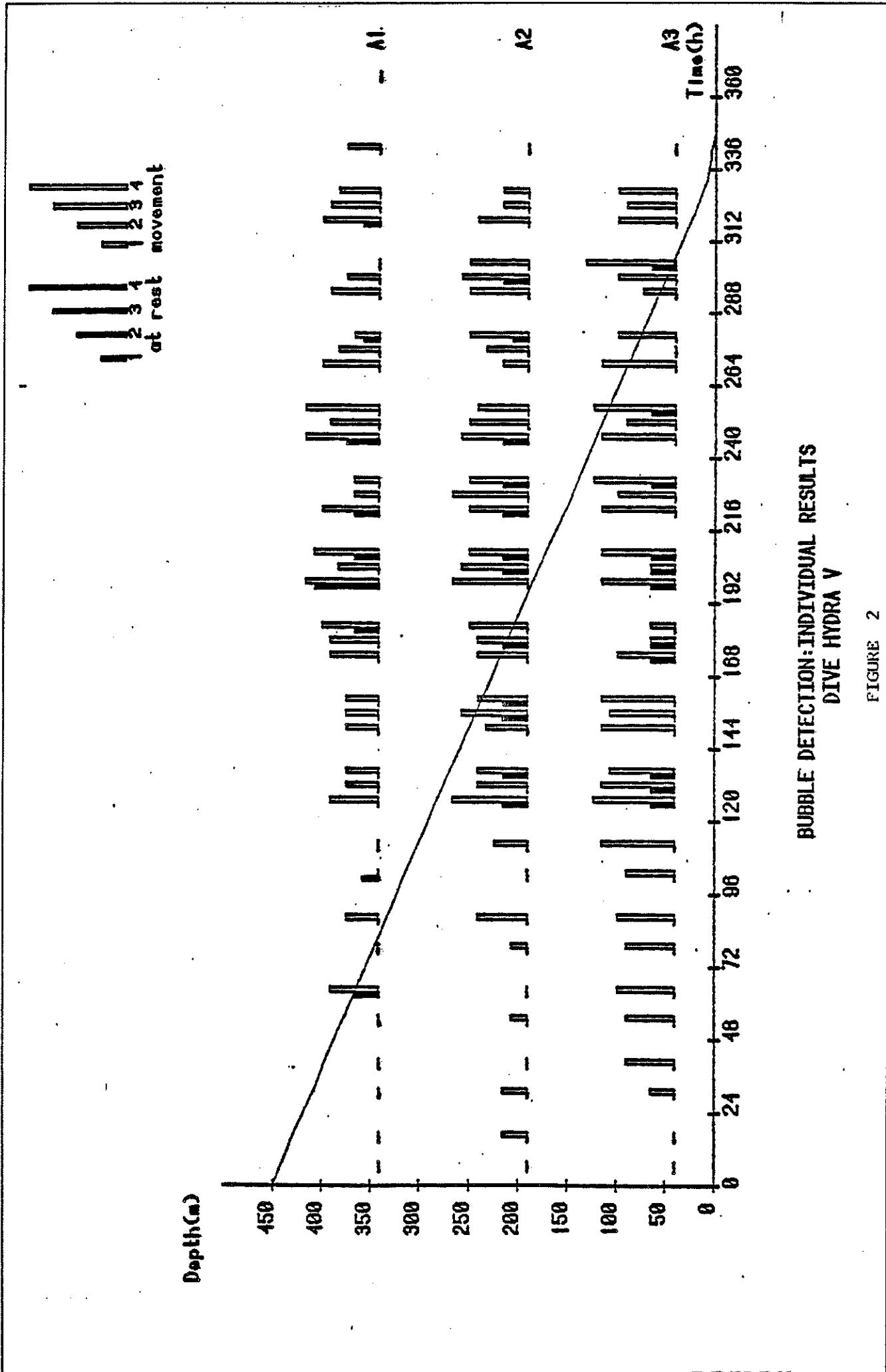

BUBBLE DETECTION: INDIVIDUAL RESULTS
DIVE HYDRA V

FIGURE 2

« THIS DOCUMENT IS THE PROPERTY OF COMEX, all information contained herein may neither be reproduced, used, disclosed, transmitted nor in any way made public without the written permission of the owner, any person in possession of this document acknowledges being bound by the obligation to treat it as confidential. »

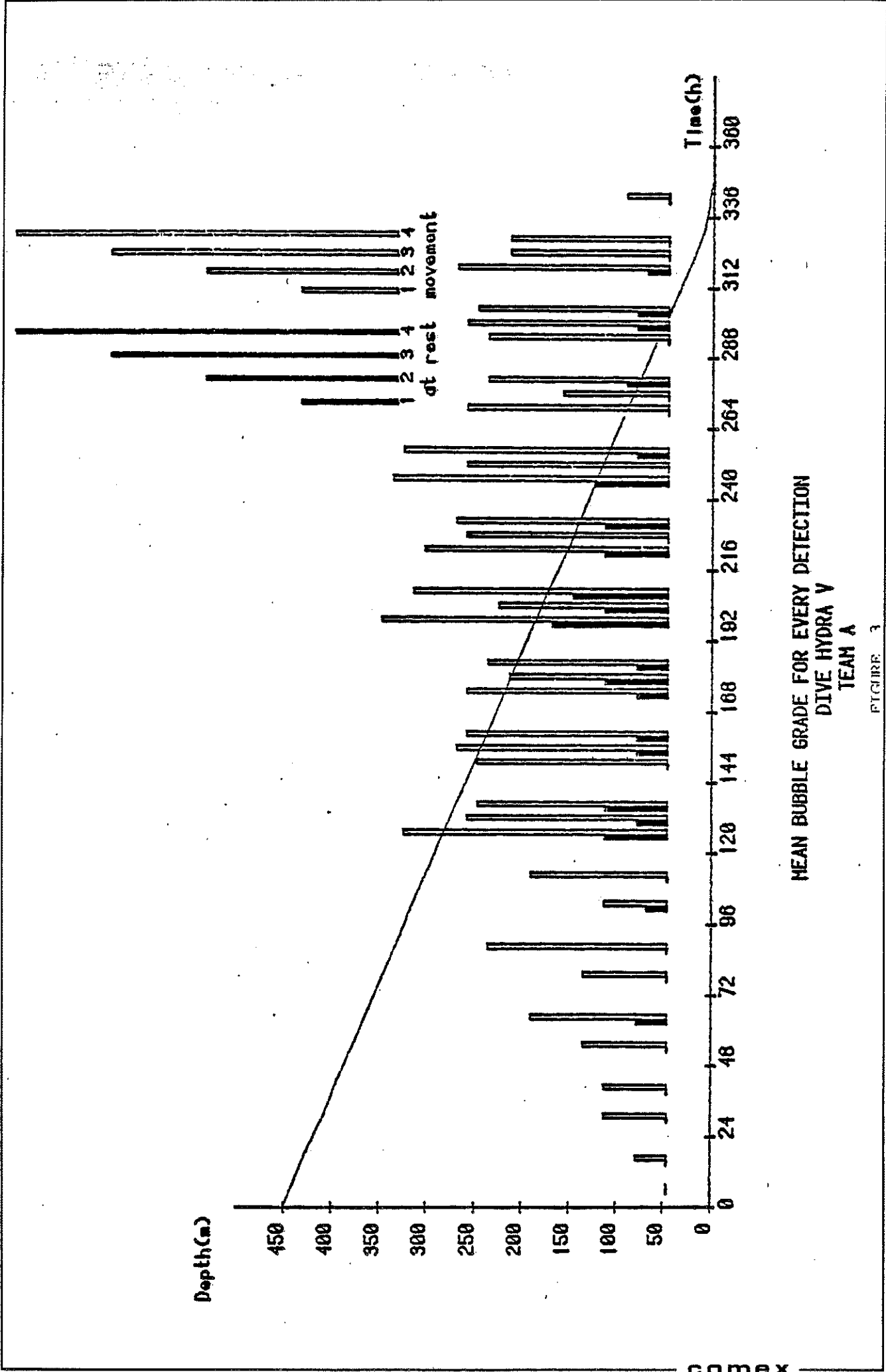

MEAN BUBBLE GRADE FOR EVERY DETECTION
DIVE HYDRA V
TEAM A

FIGURE 3

THIS DOCUMENT IS THE PROPERTY OF COMEX. All information contained herein may neither be reproduced, used, disclosed, transmitted nor in any way made public without the written permission of the owner. Any person in possession of this document acknowledges being bound by the obligation to treat it as confidential.

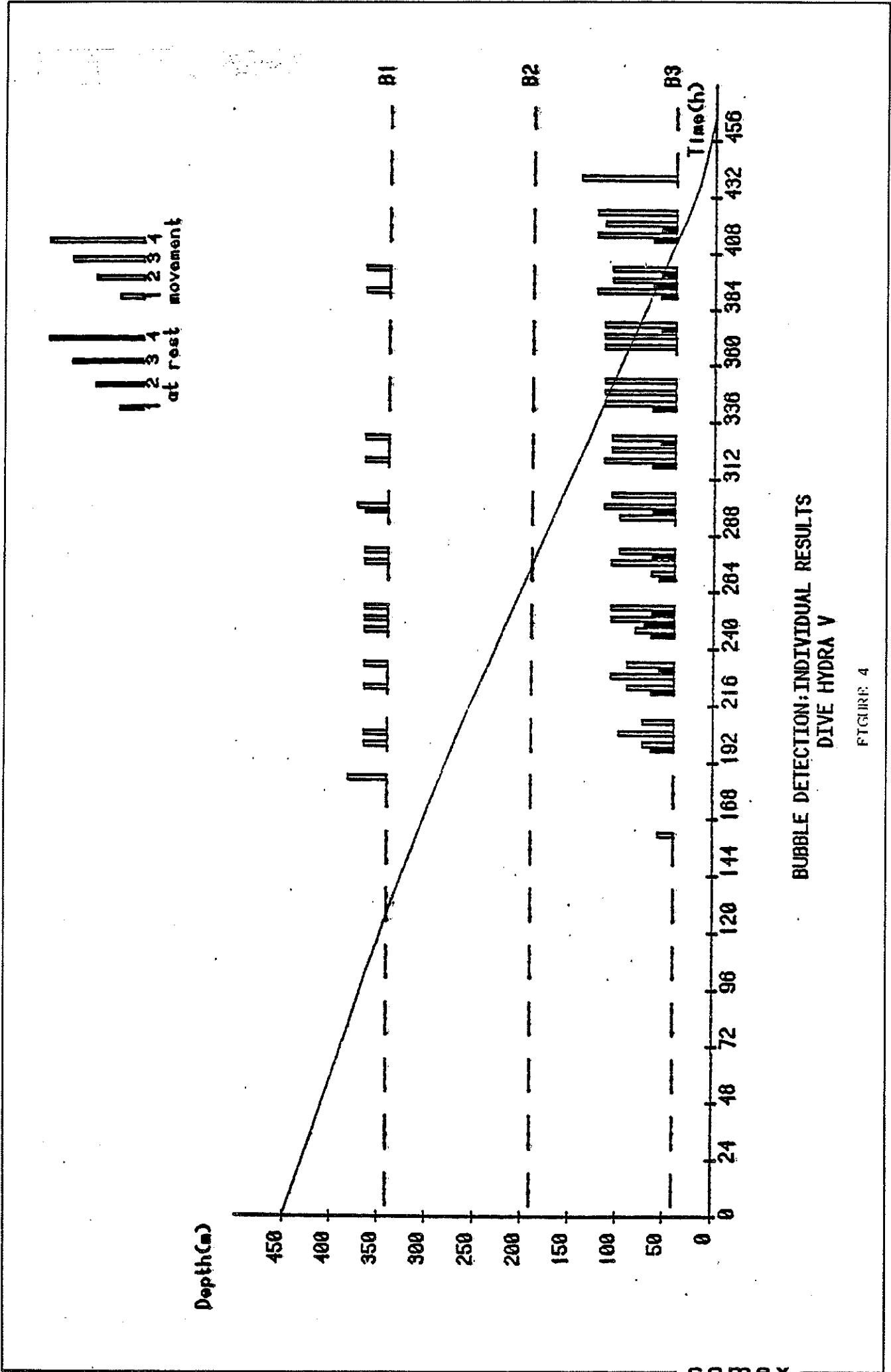

BUBBLE DETECTION: INDIVIDUAL RESULTS
DIVE HYDRA V

FIGURE 4

THIS DOCUMENT IS THE PROPERTY OF COMEX. All information contained herein may neither be reproduced, used, disclosed, transmitted nor in any way made public without the written permission of the owner. Any person in possession of this document acknowledges being bound by the obligation to treat it as confidential.

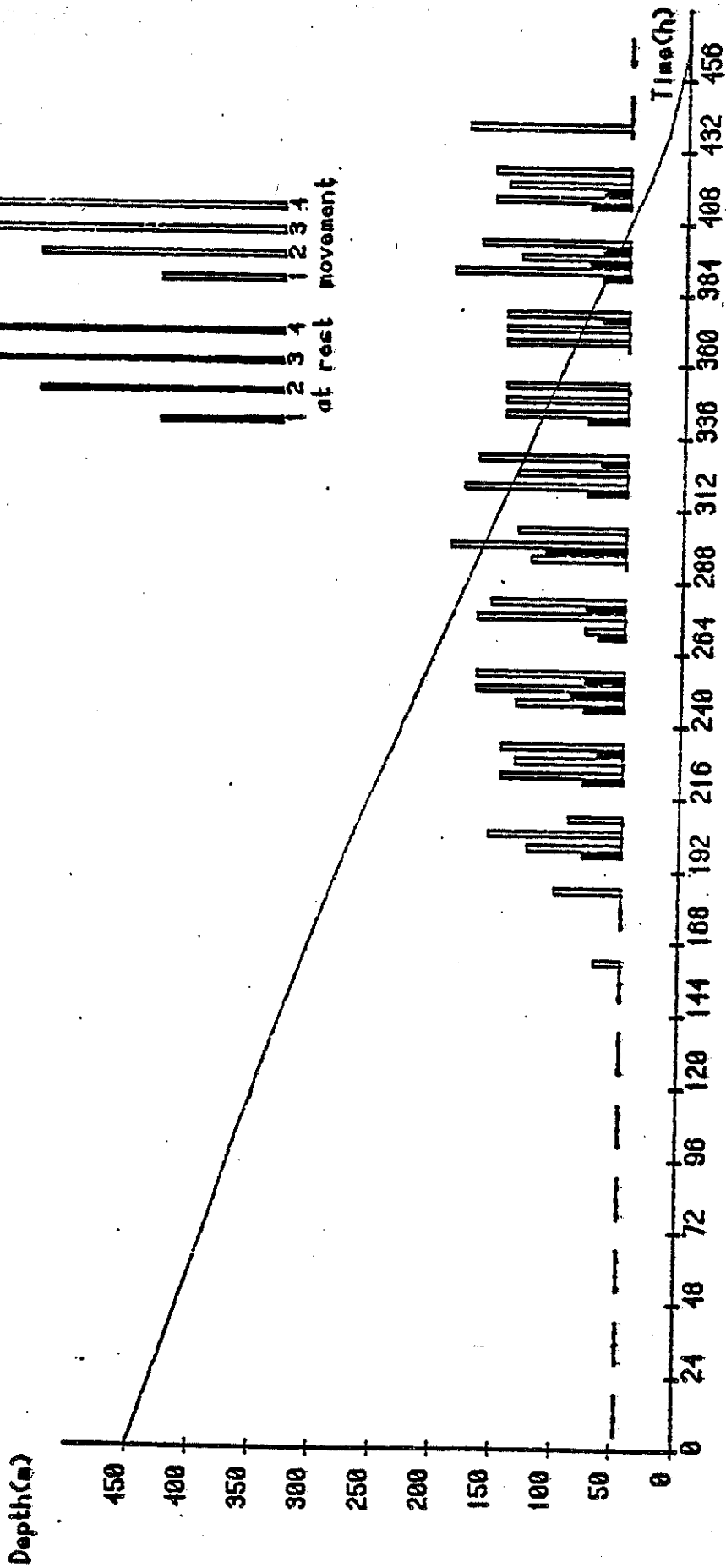

MEAN BUBBLE GRADE FOR EVERY DETECTION
DIVE HYDRA V
TEAM B

FIGURE 5

0030x

BIOCHEMISTRY

A. BARET^{*}, A. COURTIÈRE^{*}, M. VERDIER^{**}, G. PERAZZA^{***}

* EASSM-CERB, BP 610, 83800 Toulon Naval

** Medical Biology Laboratory, HIA Ste-Anne, 83800 Toulon-Naval

*** Biochemical Laboratory, HIA Ste-Anne, 83800 Toulon-Naval

During the course of the experimental saturation dive using heliox and hydrox at the COMEX Hyperbaric Research Center in May and June 1985 (Operation HYDRA V) biochemical controls were established by measuring the blood and urine factors of each team of three divers (Team A and Team B) occupying separate hyperbaric chambers. The following parameters were studied :

- Usual biological factors (counts, picture)
- Usual biochemical factors
- Muscular enzyme release due to cell injury
- Hydroelectric metabolism
- Endocrine exploration (adrenal and thyroid hypophyseal axes)

CONCLUSIONS

Analysis of the measurements made during the HYDRA V experiment indicates that :

- team B had lower enzyme counts of cardiac origin
- team B had more stable platelet counts
- team B showed fewer hypophyseal thyroid disorders
- team B showed a more pronounced tendency to transient hyperaldosteronism, or Conn's syndrome.

While these observations do not constitute sufficient basis for evaluating the effect of hydrogen at high pressure on human beings, they may prove useful when analysed in conjunction with those of later hydrox dives to provide more precise data.

« THIS DOCUMENT IS THE PROPERTY OF COMEX, all information contained herein may neither be reproduced, used, disclosed, transmitted nor in any way made public without the written permission of the owner. any person in possession of this document acknowledges being bound by the obligation to treat it as confidential. »

HYDRA V

THE EFFECTS OF THE DIVE ON LUNG CAPACITIES

R. HYACINTHE, EASSM-CERB, BP 610, 83800 TOULON-NAVAL

The following lung capacities are measured before and after a deep dive in order to assess the effects of the compression, bottom time and decompression on the pulmonary function :

- 1) Vital Capacity (VC) in L_{BTPS}
- 2) Forced Expiratory Volume in 1 second (FEV1) in $L_{BTPS} \cdot S^{-1}$
- 3) Maximum Expiratory Flow Volume (MEFV) in $L_{BTPS} \cdot S^{-1}$
- 4) Maximal Voluntary Volume (MVV) in $L_{BTPS} \cdot \text{min.}^{-1}$
- 5) Carbon Monoxide Diffusing Capacity of the Lung (DLCO) in $\text{ml}_{STPD} \cdot \text{min.}^{-1} \cdot \text{torr.}^{-1}$
- 6) Carbon Monoxide Diffusing Capacity per liter (DLCO $\cdot V_E^{-1}$) in $\text{ml}_{STPD} \cdot \text{torr.}^{-1} \cdot L_{BTPS}^{-1}$

CONCLUSIONS

- 1) It is not possible to demonstrate any specific effect related to the nature of the gas on the lung capacities measured immediately after the dive.
- 2) Both of the HYDRA V operating modes were remarkably well tolerated

The rigorousness of the living and working conditions enabled one of the divers to recover from the activities he had been engaged in before HYDRA V.

DIVER A1

Age (years) : 40
 Height (m) : 1,89
 Weight (kgs) : 88
 Body surface (square meters) : 2,15

Vital Capacity (CV) in L_{BTPS} :

Pre-dive : 6.32
 Post-dive : 6.28 (compared with pre-dive) = - 0.6 %

Forced Expiratory Volume in 1 second (FEV1) in $L_{BTPS} \cdot S^{-1}$:

Pre-dive : 4.15
 Post-dive : 4.10 (compared with pre-dive) = - 1.2 %

Maximum Expiratory Flow Volume (MEFV) in $L_{BTPS} \cdot S^{-1}$:

Pre-dive : 2.45
 Post-dive : 3.93 (compared with pre-dive) = + 60.4 %

Maximal Voluntary Volume (MVV) in $L_{BTPS} \cdot \text{min.}^{-1}$:

Pre-dive : 196
 Post-dive : 208 (compared with pre-dive) = + 6.1 %

Carbon Monoxide Diffusing Capacity of the Lung (DLCO) in $\text{ml}_{STPD} \cdot \text{min.}^{-1} \cdot \text{torr.}^{-1}$

Pre-dive : 24.1
 Post-dive : 32.2 (compared with pre-dive) = + 33.6 %

Carbon Monoxide Diffusing Capacity per liter (DLCO $\cdot V_E^{-1}$) in $\text{ml}_{STPD} \cdot \text{torr.}^{-1} \cdot L_{BTPS}^{-1}$:

Pre-dive : 4.02
 Post-dive : 3.35 (compared with pre-dive) = - 16.7 %.

DIVER A2

Age (years) = 35

Height (cm) = 183

Weight (kg) = 80

Body surface (square meter) = 2.02m^2 Vital Capacity (CV) in L_{BTPS} :

Pre-dive : 5.53

Post-dive : 6.05 (compared with pre-dive) = +9.4 %

Forced Expiratory Volume in 1 second (FEV1) in $L_{\text{BTPS}} \cdot \text{s}^{-1}$

Pre-dive : 3.60

Post-dive : 3.56 (compared with pre-dive = - 1.1 %)

Maximum Expiratory Flow Volume (MEFV) in $L_{\text{BTPS}} \cdot \text{s}^{-1}$:

Pre-dive : 1.91

Post-dive : 2.02 (compared with pre-dive = + 5.2 %)

Maximal Voluntary Volume (MVV) in $L_{\text{BTPS}} \cdot \text{min.}^{-1}$:

Pre-dive : 192

Post-dive : 202 (compared with pre-dive = + 5.2 %)

Carbon Monoxide Diffusing Capacity of the Lung (DLCO) in $\text{ml}_{\text{STPD}} \cdot \text{min.}^{-1} \cdot \text{torr.}^{-1}$:

Pre-dive : 21.0

Post-dive : 20.6 (compared with pre-dive = - 1.9 %)

Carbon Monoxide Diffusing Capacity per liter ($\text{DLCO} \cdot \sqrt{V_E}^{-1}$) in $\text{ml}_{\text{STPD}} \cdot \text{torr} \cdot \text{L}_{\text{BTPS}}^{-1}$:

Pre-dive : 2.10

Post-dive : 2.26 (compared with pre-dive : + 7.6 %)

DIVER A3

Age (years) = 34

Height (cm) = 176

Weight (kg) = 74

Body surface (square meter) = 1.90

Vital Capacity (CV) in L_{BTPS} :

Pre-dive : 6.25

Post-dive : 6.21 (compared with pre-dive) = - 0.6 %

Forced Expiratory Volume in 1 second (FEV1) in $L_{BTPS} \cdot S^{-1}$

Pre-dive : 5.01

Post-dive : 4.92 (compared with pre-dive = - 1.8 %)

Maximum Expiratory Flow Volume (MEFV) in $L_{BTPS} \cdot S^{-1}$:

Pre-dive : 4.81

Post-dive : 4.85 (compared with pre-dive = + 0.8 %)

Maximal Voluntary Volume (MVV) in $L_{BTPS} \cdot \text{min.}^{-1}$:

Pre-dive : 172

Post-dive : 208 (compared with pre-dive = + 20.9 %)

Carbon Monoxide Diffusing Capacity of the Lung (DLCO) in $\text{ml}_{STPD} \cdot \text{min.}^{-1} \cdot \text{torr.}^{-1}$:

Pre-dive : 25.7

Post-dive : 26.4 (compared with pre-dive = + 2.7 %)

Carbon Monoxide Diffusing Capacity per liter (DLCO $\cdot \dot{V}_E^{-1}$) in $\text{ml}_{STPD} \cdot \text{torr}^{-1} \cdot L_{BTPS}^{-1}$:

Pre-dive : 1.84

Post-dive : 2.45 (compared with pre-dive : + 33.1 %)

DIVER B1

Age (years) = 32
 Height (cm) = 176
 Weight (kg) = 73
 Body surface (square meter) = 1.89

Vital Capacity (CV) in L_{BTPS} :

Pre-dive : 5.60
 Post-dive : 5.67 (compared with pre-dive) = + 1.2 %

Forced Expiratory Volume in 1 second (FEV1) in $L_{BTPS} \cdot S^{-1}$

Pre-dive : 4.16
 Post-dive : 4.04 (compared with pre-dive = - 2.9 %)

Maximum Expiratory Flow Volume (MEFV) in $L_{BTPS} \cdot S^{-1}$:

Pre-dive : 3.11
 Post-dive : 2.91 (compared with pre-dive = - 6.4 %)

Maximal Voluntary Volume (MVV) in $L_{BTPS} \cdot \text{min.}^{-1}$:

Pre-dive : 156
 Post-dive : 170 (compared with pre-dive = + 9 %)

Carbon Monoxide Diffusing Capacity of the Lung (DLCO) in $\text{ml}_{STPD} \cdot \text{min.}^{-1} \cdot \text{torr.}^{-1}$:

Pre-dive : 35.4
 Post-dive : 22.6 (compared with pre-dive = - 36.2 %)

Carbon Monoxide Diffusing Capacity per liter ($DLCO \cdot \bar{V}_E^{-1}$) in $\text{ml}_{STPD} \cdot \text{torr} \cdot \text{L}_{BTPS}^{-1}$:

Pre-dive : 3.38
 Post-dive : 3.40 (compared with pre-dive : + 0.6 %)

DIVER B2

Age (years) = 31
 Height (cm) = 179
 Weight (kg) = 75
 Body surface (square meter) = 1.94

Vital Capacity (CV) in L_{BTPS} :

Pre-dive : 5.40
 Post-dive : 5.83 (compared with pre-dive) = + 8 %

Forced Expiratory Volume in 1 second (FEV1) in $L_{BTPS} \cdot S^{-1}$

Pre-dive : 4.09
 Post-dive : 4.55 (compared with pre-dive = + 11.3 %)

Maximum Expiratory Flow Volume (MEFV) in $L_{BTPS} \cdot S^{-1}$:

Pre-dive : 3.48
 Post-dive : 4.10 (compared with pre-dive = 17.8 %)

Maximal Voluntary Volume (MVV) in $L_{BTPS} \cdot \text{min.}^{-1}$:

Pre-dive : 139
 Post-dive : 174 (compared with pre-dive = + 25.2 %)

Carbon Monoxide Diffusing Capacity of the Lung (DLCO) in $\text{ml}_{STPD} \cdot \text{min.}^{-1} \cdot \text{torr.}^{-1}$:

Pre-dive : 24.7
 Post-dive : 34.6 (compared with pre-dive = + 40 %)

Carbon Monoxide Diffusing Capacity per liter ($DLCO \cdot \dot{V}_E^{-1}$) in $\text{ml}_{STPD} \cdot \text{torr} \cdot \text{L}_{BTPS}^{-1}$:

Pre-dive : 2.36
 Post-dive : 3.79 (compared with pre-dive : + 60.6 %)

DIVER B3

Age (years) = 34
 Height (cm) = 172
 Weight (kg) = 75
 Body surface (square meter) = 1.88

Vital Capacity (CV) in L_{BTPS} :

Pre-dive : 4.77
 Post-dive : 4.84 (compared with pre-dive) = + 1.5 %

Forced Expiratory Volume in 1 second (FEV1) in $L_{BTPS} \cdot S^{-1}$

Pre-dive : 3.57
 Post-dive : 3.68 (compared with pre-dive = + 3.1 %)

Maximum Expiratory Flow Volume (MEFV) in $L_{BTPS} \cdot S^{-1}$:

Pre-dive : 3.30
 Post-dive : 3.49 (compared with pre-dive = + 5.8 %)

Maximal Voluntary Volume (MVV) in $L_{BTPS} \cdot \text{min.}^{-1}$:

Pre-dive : 177
 Post-dive : 169 (compared with pre-dive = - 4.5 %)

Carbon Monoxide Diffusing Capacity of the Lung (DLCO) in $\text{ml}_{STPD} \cdot \text{min.}^{-1} \cdot \text{torr.}^{-1}$:

Pre-dive : 23.9
 Post-dive : 21.0 (compared with pre-dive = - 12.1 %)

Carbon Monoxide Diffusing Capacity per liter ($DLCO \cdot \dot{V}_E^{-1}$) in $\text{ml}_{STPD} \cdot \text{torr}^{-1} \cdot L_{BTPS}^{-1}$:

Pre-dive : 3.19
 Post-dive : 2.30 (compared with pre-dive : - 27.9 %)

« THIS DOCUMENT IS THE PROPERTY OF COMEX, all information contained herein may neither be reproduced, used, disclosed, transmitted nor in any way made public without the written permission of the owner, any person in possession of this document acknowledges being bound by the obligation to treat it as confidential».

HYDRA V

SCINTIGRAPH EXAMINATION

A. ELIZAGARAY, B. PUECH - C.E.R.B., 83800 TOULON-NAVAL

Lung examinations using Xenon 133 and bone examinations using MDP Tc 99 m were carried out on all of the divers before and after the HYDRA V dive, but the exertion test with intravenous injection of Thallium 201 was only carried out before the dive. The same protocol was followed as for the ENTEX 8 and 9 dives.

The Xe 133 lung examination was made preparatory to studying the ventilation, the perfusion, and the ventilation/perfusion ratio. The results of these examinations are correlated with the results of the functional respiratory examinations carried out the same day. The dissolved Xenon content and the "rinsing" rate of certain tissues can also be studied.

Bone scintigraphy reveals any local modifications in the phosphocalcic metabolism which may occur during the dive and which will show up as hyperfixations. The exertion test with Thallium 201 injection combined with ECG is used to eliminate any possible latent coronary pathology.

CONCLUSIONS

Diver B3 had a significant hyperfixation in the proximal epiphysis of the left tibia, and the other five divers showed a diffuse increase in fixation of the joints of the lower limbs. Xe 133 lung examination demonstrated little or no variation in the ventilatory parameters but a decrease in the peak perfusion with an increased ventilation/perfusion ratio. The Thallium 201 exertion test eliminated any latent coronary lesions in the six divers.

THIS DOCUMENT IS THE PROPERTY OF COMEX, all information contained herein may neither be reproduced, used, disclosed, transmitted nor in any way made public without the written permission of the owner, any person in possession of this document acknowledges being bound by the obligation to treat it as confidential.

HYDRA V

ODOROUS PROPERTIES OF SOME GASES IN HYPERBARIC ATMOSPHERE

P. LAFFORT, CNRS, GIF-SUR-YVETTE

Odorous properties of some gases in hyperbaric atmosphere

P. LAFFORT* and C. GORTAN**

*Laboratoire de Physiologie de la Chimioréception, C.N.R.S.,
91190 Gif-sur-Yvette (France)

**COMEX S.A., 36 Boulevard des Océans, 13275 Marseille-Cedex 9 (France)

The unique demonstration of an olfactory perception at hyperbaric atmosphere, for gases inodorous at normal atmosphere, was made by P. Laffort (Thesis, Paris-Orsay, France, 69 p., 1966 ; and in Theories of odor and odor measurement, N. Tanyolac ed., Maidenhead, U.K., Technivision, 247-270, 1968) (1). Nevertheless, two difficulties arose with this former experimentation. First, the pressure was limited to 5 absolute atmospheres (ATA), on account of the security of the subjects. Secondly, the temperature was not maintained constant, and it is well known that the olfactory perception is also depending on this parameter.

The present experimentation was carried out in a range of 2-23 ATA, in atmosphere of heliox (helium + oxygen), at $30^{\circ} \pm 2^{\circ} \text{C}$ (comfort temperature in helium), during the decompression period of the HYDRA V operation. Three of the divers of this operation acted as subjects (L. Schneider, P. Raude and J.G. Marcel-Auda). Polyethylene bags closed by a glass nose piece were used and filled with studied gases (methane and krypton). The bags were filled at the time of the measure by the divers themselves from a 1 liter water capacity bottle, identified by code names. The odourless control was constituted by a third bag filled with helium. The experimentation was completed by a measure at normal atmosphere with 9 other subjects.

From "odorous" and "odourless" responses, a dose-response curve was obtained entirely for methane and partially for krypton. The olfactory thresholds (50 % of positive responses) were evaluated at 2 ATA for krypton and 3 ATA for methane. Partial pressures of impurities, calculated from data of AIR LIQUIDE Company, can be considered as negligible at these pressures. The lowest pressures for which the two gases were olfactorily perceived with 100 % of positive responses are 6 and 13 ATA, respectively for krypton and methane. According to the terms used by the divers, the odour quality of the two studied gases seems of "chloroform" type, with, in addition, an "irritating" touch for krypton and a "refreshing" one for methane. From several considerations, it can be assumed that the sensation induced by methane and krypton is olfactory and not gustatory of "sweet" type.

The higher odority of a gas in hyperbaric atmosphere is explained by a higher concentration of this substance at receptor cells level : in the case of pure gases, the partial pressure equals the environmental total pressure. The results obtained demonstrate the existence of olfactory sensitivity for these substances known as inodorous. Moreover, planning structure-activity relationships, it is possible, by this way, to know the olfactory thresholds of small molecular weight compounds (for example, human thresholds of n-paraffin were known in a range of C2-C18 till now).

(1) E.M. Case and J.B.S. Haldane (Nature, 148, 84, 1941) found, by total immersion of the subjects in the gases to be studied, a metallic sapidity for oxygen and nitrogen, respectively at 8 and 10 ATA (absolute atmospheres).

« THIS DOCUMENT IS THE PROPERTY OF COMEX, all information contained herein may neither be reproduced, used, disclosed, transmitted nor in any way made public without the written permission of the owner, any person in possession of this document acknowledges being bound by the obligation to treat it as confidential».

HYDRA V

OPHTHALMOLOGICAL MEASUREMENTS

D. GULDNER, C.O.M., Martigues France

INTRODUCTION

On HYDRA V occasion, an ophthalmologist was integrated into the scientific team of an experimental dive for the first time at COMEX.

A fairly complete range of ophthalmological and neuro-ophthalmological tests was carried out on each of the two teams, five times and under specially adapted technical conditions.

An important quantity of measures was obtained. Results, which are surprising at times, should be considered with care, compared with those of other special fields, checked during hydrogen dives or more classical ones in order to define variation factors better.

We will study :

- relations between ophthalmology and experimental and professional diving,
- measures realized in Martigues Ophthalmological Centre (MOC),
- chosen tests and means used to carry them out,
- experimentation results,
- possible conclusion,
- and we will try to anticipate in which direction future research should be done.

I - OPHTHALMOLOGY DURING EXPERIMENTAL AND PROFESSIONAL DIVING

1) Why Ophthalmology ?

Sight being one of the senses, one can wonder whether :

- environmental perception is modified as far as visual acuity or visual field is concerned,
- a manual worker's binocular vision and therefore his notion of relief is affected,
- an acquired dyschromatopsia alters perception of safety signals or estimation of work realised by a welder

So : sensorial modification and efficiency, anticipation of accident at work risk, but also from a neuro-ophthalmological point of view, achievement of additional results.

2) Ophthalmologist and experimental diving

A professional clinician, whatever his additional training and diving or aeronautical medicine and his habit of sport diving is, knows little about professional diving and even less about experimental one.

He must integrate into a team of researchers that often work in a laboratory and have know one another for many years whereas his special field is not well known.

He must understand divers in their reactions and through a vocal decoder, during a relatively heavy experimental program.

He must adapt his research means to diving systems.

3) Examination conditions :

The technique used to carry out the tests is largely modified. It is difficult to observe the diver, especially his corneal reflex and therefore his fixation. His voice is hardly understandable at times. The volume of the equipment which is sometimes needed in duplicate as it was the case for the HYDRA V experiment and its two chambers is limited by the exiguity of the chambers.

No light source can be introduced into hydrogen atmosphere.

Light has sometimes little intensity and does not reproduce solar spectrum : in addition, its reflexion on very closewalls modifies its wavelengths.

So, luminosity on the tests table was 400 Lux inside the spheres, 180 Lux inside the chamber, therefore at the limit of high mesopical illumination.

Portholes, through which the visual field was done, were 10 cm thick, with a 19 cm diameter in the spheres : 11.34 and 30 in the chamber.

As a result, the choice of tests and devices was affected by these conditions and techniques used to carry them out had to be adapted.

4) Choice of the tests :

Our choice was influenced by a previous work (1977, Toulouse - thesis : Investigation means in clinical experimentations of neurovasculotrop medicines in degenerative ocular pathology), our daily opthalmological practice, our knowledge of diving and aeronautical medicine and our practice of sport diving.

Tests had to be of current usage, using devices available in the whole world, providing results with figures excluding any notion of "better or not so good"; they also had to be easily learnt and performed by the divers, compatible with the above mentioned environmental facts, comparable in the two chambers, and be easily reproduced by any team.

II - DIVERS' EXAMINATION AT MARTIGUES OPHTHALMOLOGICAL CENTER (M.O.C.)

1) General information

The M.O.C., where three doctors and two orthoptists work permanently, belongs to a group of nine opthalmological surgeons; they have very complete and

sophisticated therapeutical and investigation means.

Two teams of 4 and 5 divers were examined for 5 hours in front of COMEX and GISMER doctors; this would have been felt as long and exhausting by any patient. One must acknowledge their real cooperation.

List of tests and their presentation appear on the enclosed annex. We use these tests daily; they are hardly aggressive and were giving us all the necessary information for diving.

Only the pupillary dilatation after cyclopegic effect necessary to examine retinal fundus periphery seems to have affected the divers, because of its average of 18 hours remanence.

Each battery of tests was preceded by an explanation.

Examination of ocular motor functions and initiation to the tests to be carried out in a caisson were perfected by M.O.C.

Colour tests and visual fields which had to be carried out in a caisson under very special conditions were not perfected at M.O.C.

2) Results

Visual acuity is good only apparently. As a matter of fact it is 6/30 or 20/100 in A2 and B2 because of a noticeable latent hypermetropia that required a correction of presbyopia in one diver (A2) at the age of 35. Separate reading glasses were prescribed and worn during the test after a first phase devoted to getting accustomed to them.

A more or less important exophoria appears with MADDIX wing test.

Among the selected divers, fusion is bad in a diver (B2) who has a non-corrected hypermetropia.

No glaucomas were found.

In the ocular fundus eye, a tendency to an increase of the minimum ophthalmic artery pressure and to a retinal arterial narrowing, among divers who were examined, is noticeable; finally one man (A1) shows some modifications in the retinal periphery.

III - TESTS USED

- Visual acuity was measured according to SNELLEN and ROSSANO-WEISS charts in order to eliminate any clues given by letters.
- The amplitude of accommodation is the value of the difference between the far point and the near point. The near point was measured from the TRAGUS, to avoid quivering with a graduated rule on the smallest R.W. tests.
- The MADDIX wing test, which dissociates each eye image close to measure the position of one eye in relation to the other.

No deviation is called orthophoria, external deviation is called exophoria,

internal : esophoria and altitudinal : hyperphoria.

- The prism bar deviates light rays towards its base. If binocular vision is maintained, the eyes rotate to preserve fusion.

Divergence was found always normal and vertical deviation was found exceptional during preliminary tests, only convergence was measured from far and near distance. Norms are 20 and 40 prismatic dioptries respectively.

- Color tests were carried out with the FARSWORTH 100 HUE.

This test, which is time consuming and tedious but very sensitive, consists of classifying 85 coloured chips covering the visible spectrum. It detects congenital and acquired deficiencies in the perception of one of the three fundamental colours and given an error score. Considering the weak luminosity and the time available, the test was carried out in binocular and for about 20 minutes.

According to the kind of ocular impairments it is found, classically, a red-green defect in macular lesion, a blue-yellow defect in retinal peripheral lesions, and a green-red defect in optic nerve pathology.

The visual field was achieved with a multiple stimuli static perimeter, FRIEDMAN type.

The subject's head maintained on a chin rest from where a mesopic illumination is given, is located 33 cm away from a screen which has a 36 cm diameter and 46 holes lit up by set of 2, 3 or 4 thanks to a XENON flash. Values of neutral filters which reduce target luminosity and detect thresholds of each point are transcribed on a diagram. Putting that test into practice has turned out to be particularly difficult, since it was achieved through a thick and narrow porthole, the chin rest and so the lighting of screen suppressed, whereas a 33 cm distance was kept. Various devices made that examination reliable and reproductible from one chamber to the other. The three divers were tested in about 30 minutes.

IV - RESULTS

This test program was carried out on each diver 5 times, except for the mesopical vision which would have been too tiring as far as time is concerned because of the time required to dark adaptation for the vision of colours during the fifth test, since team B was tired and close to going out.

Tests were carried out on day (D) : 2. 6. 13. 15. 27 for team A

and day (D) : 0. 3. 7. 18. 21 for team B

In each case we had 90 minutes that turned out to be sufficient to set up and carried out each test as well as transcribe the results.

Except for the visual field, results were transcribed by the divers themselves and put through a screen at the end of the day.

1) Visual acuity ;

a) far vision results regarding team A were normal or sometimes not entirely transcribed.

As for B2 and specially B3, variations must be compared with troubles of the visual field.

b) near vision, the divers transcriptions cannot be interpreted. This may be due to the complicated marking system of the R.W. chart. Nevertheless, minimum distances of clear near vision, always below 20 cm, lead us to think that for a measure conventionally realized at 35 cm, modifications are not major ones.

c) amplitude of accommodation :

- . was obviously disturbed,
- . maximum impairment was reached at 450 m
- . curves were often biphasic.

2) Ocular motility examination.

A difference between tests carried out at M.O.C. and the confining phase ones was observed. Is this due to the influence of the orthoptist controlling the first tests or to the divers being left to themselves, or to the influence of accommodation which hardly relaxes in a reduced space or already the influence of gas or pressure and physical adaptation ?

1 - With the MADDOX test wing the exophoria diminished in , at least, 4 cases. In 3 cases it was reduced even reversed.

2 - With the prism bar, it is mainly the near convergence which is altered. The near and far representative curves were sometimes crossing. So stereoscope vision at half and sometimes near distance would be disturbed, and its influence on some psychometrical tests must be discussed. Training through repeating the tests should improve it.

3 - Visual field.

Perception of stimuli located on the two more peripheral area was clearly altered; modifications made on the equipment, the noticeable increase in the portholes thickness through obliquity, the frequency of the phenomenon in current OPH. practice do not make us take that alteration into account.

A decrease of paracentral sensitivity will appear in three divers. Mainly for the same diver : B3. On D.7 a decrease of pericoecal sensitivity of the left eye was observed. On D 18 the pericoecal scotoma was enlarged and on the right eye it was found a slight decrease of nasal sensitivity, calling to mind a left lateral homonymous defect.

In B1, a very relative left peri central defect on D7, left pericoecal on D18.

In B3 and B1, these defects seemed to be an associated modification of visual

acuity.

A3 also shows a fairly discreet pericoecal bilateral defect, prevailing on the right on D 27.

Scores obtained by adding neutral filters, periphery excluded, would tend to confirm these results.

Because of their distribution, these defects did not allow to make a difference between helium and hydrogen and between the two chambers.

4) Color vision

Two types of deficiencies have been observed.

a) In the reference measures realised in confinement isolated errors between 510 and 480 nanometers were found. These errors could be attributed to low illumination, characterized by a beginning of blue-yellow axis on mesopic level.

b) A dyschromatopsia axis appears in A1, A3 and more or less in A2 on D 13, 15, 27, in B1, B2, B3 on D3, D7, more or less on D 18.

Errors reached their maximum for both teams in the first and third box-sample, which corresponded to a triton axis, and so to a deficiency in the blue.

These deficiencies varied through time and although the axis varied, it stayed tritan which was a confirmation of an acquired and dynamic deficiency. The mesopic level cannot be put forward specially since the chamber stays the same for team B.

5) Hydrophilic contact lenses

We had been given by ESSILOR Laboratories discs made of ES 70 material and Lunelle lenses which, put into protected flasks of physiological salt solution but left open were placed in both chambers.

ESSILOR gave us the following results :

- As for as the discs are concerned, it was noticed that two samples out of twelve showed an increase in thickness varying from 1 to 4/100 th after diving.

- As for as the lunette lenses are concerned, two out of four showed an increase in the internal curve ray of 8 to 10/100th as well as an increase in the total diameter for three of them, a variation of about 5 to 15/100th.

Still concerning the lunette lenses, it was noticed a fungal presence on two of them and, on the four others, either a violet light or a slight pink colouring.

6) Synthesis

- First of all we must point out that, except for the retinal arterial vessels and their pressure, the test which was realized in the OPH centre is normal and showed no sign of a chronical pathology.
- Some of the tests which were carried out are open to a development in their practising and so a progressive improvement in results could have been observed.
- The two groups differed at times but results remained homogeneous in a same group.
- The effects changed through time without allowing us to differentiate the effect of the various gases or of the pressure.
- It is difficult to differentiate the two chambers : this fact underlines the reliability of our tests.
- Several types of curves were observed.
 - maximum deficiency at the beginning of the stage at 450 m
 - maximum deficiency at the end of the stage
 - finally biphasical curves
- Curves between D6 and D13 are uncertain considering D8 for Team A.
- Finally the etiopathogenia of these troubles is difficult to assert :
 - it is probably several neuro-ophthalmological structures the function of which has been altered, considering the variety of disturbed tests.
 - for a same structure, such as retina, it is not so much a question of a vascular or neurological systematization than a question of showing a greater sensitiveness to a factor of a cells population : specific cones of the blue for the 100 HUE or average zone for example for the Friedman.
 - very few common denominators can be really mentioned by an ophthalmologist and, for a first work, one could not reason by analogy without extreme care.

V - WORK PROSPECT

- The choice of the tests seemed to be good and gave a fairly wide range of ophthalmological exploration
- Time needed for testing can be evaluated at 30 minutes per diver
- the choice of 5 sets of tests programmed by COMEX is to be kept

Considering the types of curves obtained, the tests should be performed :

- in confinement
 - shortly after arriving at the maximum depth
 - shortly before leaving it
 - shortly after the beginning of the ascent
 - and during decompression
- They are very few modifications to be brought to the way the tests were carried out, only :
 - a closer supervision of the results transcription by the divers
 - a more sophisticated installation for the Friedmann
 - The pressure and various gas own influence could be determined by a daily practice of some very short tests, in 5 or 10 min, for example : remaining accommodation, Maddox, prisms.
 - If phenomenons of an accumulative type were confirmed, could the ophtalmologist participate in estimating the maximum duration of a stage ?
 - The arrival of new devices such as the ERG, EOG, PEV which do not require pupillar dilatation or contact lenses, would allow an exploration of the central and peripheral retina of the secondary optical ways and of the scotopic and photopic systems.
 - At the eye fundus, vessels and the PAO could be checked on a great number of divers and allow statistics calculation.
 - In the absence of any ophtalmological references, taking the etiological hypothesis and prospects which are now open into consideration, these tests will have to be repeated at identical and inferior depths in using Nitrogen, Heliox, Trimix mixes and also at greater depths.

CONCLUSION

For the first time in deep experimental diving and for the first time in an hydrogen mixture, a set of ophtalmological tests has been carried out, showing a wide range of the speciality and giving a very satisfactory amount of results thanks to the fact that 5 measures were made possible.

These tests were obviously disturbed.

Considering the results obtained, the non-agressiveness of the tests, the accuracy of the results and of the etiological hypothesis, the participation of neuro-ophtalmology and ophtalmology could well be thought of for future diving.

« THIS DOCUMENT IS THE PROPERTY OF COMEX, all information contained herein may neither be reproduced, used, disclosed, transmitted nor in any way made public without the written permission of the owner. any person in possession of this document acknowledges being bound by the obligation to treat it as confidential. »

S U M M A R Y

X. FRUCTUS

Scientific Management - COMEX - Marseille

1 - TECHNOLOGICAL IMPERATIVES

The preliminary study of the flammability of ternary hydrogenated mixtures, the rigorous control of the quality of hydrogen used as a breathing gas and the adapting of hyperbaric equipment to hydrox constituted the most important elements in the preparation of HYDRA V. In accordance with the requirements set down by C. Gortan, the procedures for the use of saturation diving equipment were defined so as to preclude the presence of any flammable mixture at any time and any place in the hyperbaric complex and its peripheral equipment. Due to the equally high level in the competence of the surface personnel and the quality of the installation, the 18 days "on hydrogen" passed without any mishaps.

2 - STUDY OF BEHAVIOUR AND MEDICAL SUPERVISION

The harmlessness of hydrogen as a breathing gas during long exposure was confirmed.

Our rough calculation of the P_{H_2} level tolerable at 450 m was found to be valid and although the "hydrogen effect" was perceptible, especially in team B, we are inclined to believe that a lower P_{H_2} (23 bars instead of 25) would have further normalised the neuropsychic state of the six men - none of whom sustained any HPNS disorders while breathing the ternary mixtures of more than 25 % hydrogen.

We were expecting a resurgence of HPNS on heliox but not so pronounced, in view of the fact that we took the precaution of putting the three divers on an intermediate mixture of 30 % H_2 for 8 hours.

With the switch to pure heliox at 46 ATA, on the basis of our experience with HYDRA IV we were prepared for an effect of isobaric counterdiffusion, but we underestimated it, if only because of its variability from one individual to another and the precautions we had taken of an 8-hour transit on 30 % H_2 .

The formation of circulating generalised subcutaneous bubbles (Doppler : 2⁺) in diver A₂ - although quite quickly curbed by recompression of 2 bars - constitutes one experimental result which should be taken into account for the future of industrial diving with hydrogenated mixtures. It is important to ascertain whether switching breathing mixtures (chambers on heliox, diving bell and divers on hydrox, for instance) is not something to be avoided in underwater work.

As for team A, the three divers would have been glad to remain on hydrox, they felt so good at 450 m - "like heliox at 200 or 250 meters"....

3 - NEUROPHYSIOLOGY AND PSYCHOLOGY

Exposure to a hydrox mixture of 54 % H₂ did not serve to prevent electro-encephalographic modifications, noted regularly by J.C. Rostain at 450 m - both on heliox and nitrogen trimix - and more particularly in the four divers who had had experience at this depth.

Neither did hydrox prevent disturbance of sleep patterns... but how sure can we be that a certain amount of dyssomnia was not due to the constrained and cramped environment and thermal discomfort?

On the other hand, on hydrox, the absence of tremor was evidence of the disappearance (or masking) of HPNS, of which it is the primary and most constant manifestation. Tremor reappeared in the divers of team A when they went back to pure heliox.

Performance on the psychometric tests was erratic, certainly influenced, particularly in team B, by a slight degree of narcosis. Narcosis was evaluated by three cognitive tests which show a slight deterioration in performance, with broad individual variations (M. Carlioz) and a temporary learning block during the period following arrival on the bottom (R. Bugat). Nevertheless, the results of tests used previously in ENTEEX 5, 8 and 9 for the same compression profile show a definite advantage of ternary hydrox over nitrogen trimix. Finally, the Visual Choice Reaction Time with 4 choices did not undergo any significant variation during the period on hydrox, which seems to confirm clinical absence of HPNS (C. Lemaire).

As for the conative tests, aside from a feeling of tiredness the divers perceived on arrival at the bottom, these reveal (despite the variability of individual reactions) the state of stress caused by deep diving, whatever the nature of the breathing mixture. To which we should add that this stress, psychic rather somatic, is not the most pronounced form of stress encountered in occupational medicine.

4 - RESPIRATORY AND CARDIOVASCULAR PHYSIOLOGY

Three of the six subjects were thoroughly examined in the dry and according to

P. Giry, it would appear that the effects of hydrogen are due more to its neurotropic effect than to its density. The hyposensitivity of the nervous system on hydrox seems to attenuate the impression of strenuous effort and increase tolerance to a slight hypercapnia. If this should be confirmed, it would be advisable to lower the PH_2 to avoid overestimating performance possibilities.

In the wet, on the other hand, although comparative respiratory measurements were not possible G. Imbert found higher motivation among the three team B divers for exercises in immersion, in ergonomic conditions better suited to their capacities. Hence a satisfactory level of effort obtained on the cyclo-rower for periods of 25 to 31 minutes, with respiratory comfort and a ventilation of 30 l.min^{-1} on hydrogen mix. The respiratory equivalent stayed relatively high, without CO_2 retention, for moderately energetic activity approximating that of working conditions.

From a cardiovascular point of view the experimental conditions did not permit precise quantification of the difference between the exercises carried out on the two mixtures.

For team A, the results on hydrox at 450 m were closer to reference values than those on heliox - without, however, being statistically significant, in the opinion of E. Flynn. All the members of team B, fully equipped, were able to carry out in immersion what was asked of them, and in no case did the graphs show cardiac arrhythmia - but it is true that we did not test at the divers' full effort capacity.

5 - THE DECOMPRESSIONS

After their stay on heliox, team A decompressed with the same mixture at variable PIO_2 and at constant speed up to 15 m, following a well established procedure.

The first venous bubbles were detected very early, at 425 m for diver A_2 - the one who had had trouble with the switch from hydrox to heliox at the bottom - but also for diver A_3 , the one who had had the least trouble with this switch. None of this decompression was a surprise to us, not even the slight bends felt by A_1 and A_3 at 1.3 m from surface. These little terminal "hitches" are not excluded in heliox decompressions, not even ours, which has proven to be perfectly well tolerated in numerous experimental saturations carried out by COMEX and GISMER. As we all know, a decompression which is perfect for 100 % of all divers does not exist...

Decompression of team B was carried out on hydrogen mix with decreasing proportions of hydrogen up to 200 m. Slow dehydrogenation was expected to prevent the problems of counterdiffusion encountered by team A (at 46 ATM). The fall in pressure, obtained by gradual elimination of hydrogen, started at 0.86 m.h^{-1} , under Doppler control.

Observing an absence of bubbles at 350 m we increased the rate of ascent to 1 and then to 1.09 m.h^{-1} with a PiO_2 of 0.6 then 0.5 bar. Not until 280 m did a low bubble count appear in two of the three divers.

One must not forget that this was a "première" and that we disposed of only two elements to establish our decompression profile :

- the solubility of hydrogen in fat (2 1/2 times that of helium)
- the decompressions of shallow bounce dives carried out by Edel and Fife, decompressions which turned out to be very tricky and responsible for osteo-articular accidents.

Hence our wariness. But in fact this decompression, probably too slow at the beginning, was conclusive and certainly in the future desaturation by gradual elimination of hydrogen from the breathing mixture up to 200 m, without sudden change to heliox, will not need to be any slower than with pure heliox or nitrogen trimix (Usual speed : 1 m.h^{-1} or slightly more).

6 - THE EVOLUTION OF BIOLOGICAL PARAMETERS

It is noteworthy - and reassuring - that following a critical situation resulting from the switch $\text{H}_2 \rightarrow \text{He}$, experienced by team A, and after final decompression of team B on hydrox up to 200 m, the variations in the number of blood leucocytes and platelets were not significant of bubble pathology. This tends to demonstrate the fact that in this respect hydrox is at least as well tolerated as heliox, and better than air.

The variations in blood and urine chemical elements, always reversible, do not show any serious metabolic disturbances.

Only temporary hypophyseal thyroid anomalies as well as an increase in serum ferritin, could be linked to a hepatic disturbance as described by G.R. Doran et al. in divers having undergone experimental saturation at great depths on heliox, such as the 540 m and 660 m AMIE dives.

At all events molecular hydrogen does not seem to induce any specific biological disorders, nor any irreversible cytotoxicity.

7 - PULMONARY AND SCINTISCANNER EXAMINATION

The comparative study of the six divers before and after the dive HYDRA V permitted us to conclude that, as far as the lungs were concerned, these long saturations with hydrogen and helium were remarkably well tolerated by both teams - even if a Xe 133 scan did reveal a decrease in perfusion at the apex. Bone scanning permitted us to discover one case of tibial hyperfixation (diver B₃), and for the five others a diffuse and symmetrical increase in isotope fixation. Here again experience shows us that such scintigrams the cause of which has yet to be demonstrated (decompression, or bio-mechanical effects due to the constraint of confinement, as suggested by A. Elizagaray), are so commonplace and so unstable that any notion of a pathological process can be ruled out.

It is to be hoped that this brief summary, a mere glimpse into an extensive, multi-disciplinary study, will inspire a careful perusal of each individual chapter.

« THIS DOCUMENT IS THE PROPERTY OF COMEX. all information contained herein may neither be reproduced, used, disclosed, transmitted nor in any way made public without the written permission of the owner. any person in possession of this document acknowledges being bound by the obligation to treat it as confidential ».

CONCLUSION

H. G. DELAUZE

The introduction of hydrogen into breathing mixtures at high pressure already gave positive results with HYDRA IV, to a depth of 300 m. But in the interest of safety the hydrox volume there was restricted to 0.8 m^3 in a dome under which divers could stay for periods of not more than a few hours.

HYDRA IV left a number of important questions, however, which we hoped to solve by Operation HYDRA V :

1) Is it possible to adapt a conventional hyperbaric unit to the use of large volumes of hydrogen ?

Definitely. HYDRA V has proved that heavy saturation diving equipment, originally designed for helium, could be adapted to hydrogen and still satisfy safety requirements. Only some of the peripheral sub-units need modification, and thus can be achieved without prohibitive expense.

2) Would exposure for long periods to hydrogenated mixtures - until a state of saturation is reached - be well tolerated by the human organism ?

Blood and urine analysis and medical examination before and after the dive are completely reassuring. Partial hydrogen pressures of about 30 bars can be reached (and even exceeded....) without danger of intoxication.

3) Does there exist an equilibrium between the surrounding pressure and hydrogen's narcotic effect that would allow us to maintain at 450 m or more a suitable proportion of this gas in the mixture ? That is to say, a percentage high enough to neutralize HPNS and to assure a gain in pulmonray ventilation ?

This balance does exist and HYDRA V has allowed us to define it.

4) Is it possible, taking certain precautions, to switch a diver saturated at more than 50 % hydrogen at 450 m to pure heliox ?

The answer - no - is an invaluable warning : the phenomenon of isobaric supersaturation and the rebound of HPNS prohibit diving with the two mixtures (living chamber on heliox and bell on hydrox), a complicated procedure in any case and one whose economic advantages are not certain.

5) Therefore : "all-hydrox", including decompression ?

On this last point hydrogen has not substantiated its poor reputation. On the contrary, progressive elimination of this gas to a content of less than 4 % at 200 m permits a desaturation rate similar to that of heliox.

And as in all case it is man himself who is the best judge, we would like to reiterate a comment made by one of the most experienced divers, used to deep diving : "On hydrox at 450 m I had the same impression of well-being and ease as on heliox at 200 m". In short, everything confirms the fact that hydrogen permits us to gain an extra 250 meters.

HYDRA V's technological success and the mass of physiological data gathered open the way to a pre-industrialisation of diving with hydrogenated mixtures at the operating depths of tomorrow.

We should like to express our profound appreciation
to the sponsors of HYDRA V for their financial support

BP INTERNATIONAL LTD

CFP - TOTAL

CONOCO

ELF AQUITAINE

NUTEC A.S.

PRODAIR

PETROCANADA

STATOIL