



HAL
open science

JANUS IV -501m -1644 feet

Sa Comex

► **To cite this version:**

| Sa Comex. JANUS IV -501m -1644 feet. COMEX. 1977. hal-04464970

HAL Id: hal-04464970

<https://hal.univ-brest.fr/hal-04464970>

Submitted on 19 Feb 2024

HAL is a multi-disciplinary open access archive for the deposit and dissemination of scientific research documents, whether they are published or not. The documents may come from teaching and research institutions in France or abroad, or from public or private research centers.

L'archive ouverte pluridisciplinaire **HAL**, est destinée au dépôt et à la diffusion de documents scientifiques de niveau recherche, publiés ou non, émanant des établissements d'enseignement et de recherche français ou étrangers, des laboratoires publics ou privés.



Distributed under a Creative Commons Attribution - NonCommercial - NoDerivatives 4.0 International License



The present document is the property of COMEX SAS. It has been entrusted to the ORPHY laboratory, which scanned and uploaded it.

COMEX (Compagnie Maritime d'Expertises), established in 1962, has positioned itself in the offshore activities sector, where it held a leading international position, becoming the world's foremost company in engineering, technology, and human or robotic underwater interventions. Comex designed a Hyperbaric Testing Center in 1969 and developed its own research programs on various breathing mixtures used in deep-sea diving (helium and later hydrogen). These research efforts led to spectacular advancements in this field, including several world records, both in real conditions and simulations. Comex still holds the world record at -701 meters, achieved in its chambers during Operation HYDRA 10.

The ORPHY laboratory focuses on major physiological functions, their regulation, interactions, and their contribution to the development and prevention of certain pathologies. The primary mechanisms studied involve metabolic aspects (oxygen transport and utilization, energetics, etc.) and electrophysiological aspects (contractility and excitability), mainly related to respiratory, vascular, and/or muscular functions. These mechanisms are studied under various physiological and physiopathological conditions, ranging from the cellular and subcellular levels to the entire organism. In Europe, the ORPHY laboratory is one of the leaders in hyperbaric physiology and diving research.

Being a major player in innovation and expertise in the field of pressure, COMEX maintains a scientific archive from its experimental diving campaigns. The value of this archive is both scientific and historical, as it documents a remarkable chapter in the history of marine exploration and contains results obtained during dives that are very unlikely to be replicated in the future.

comex

JANUS IV

501 METRES
—
1644 FEET

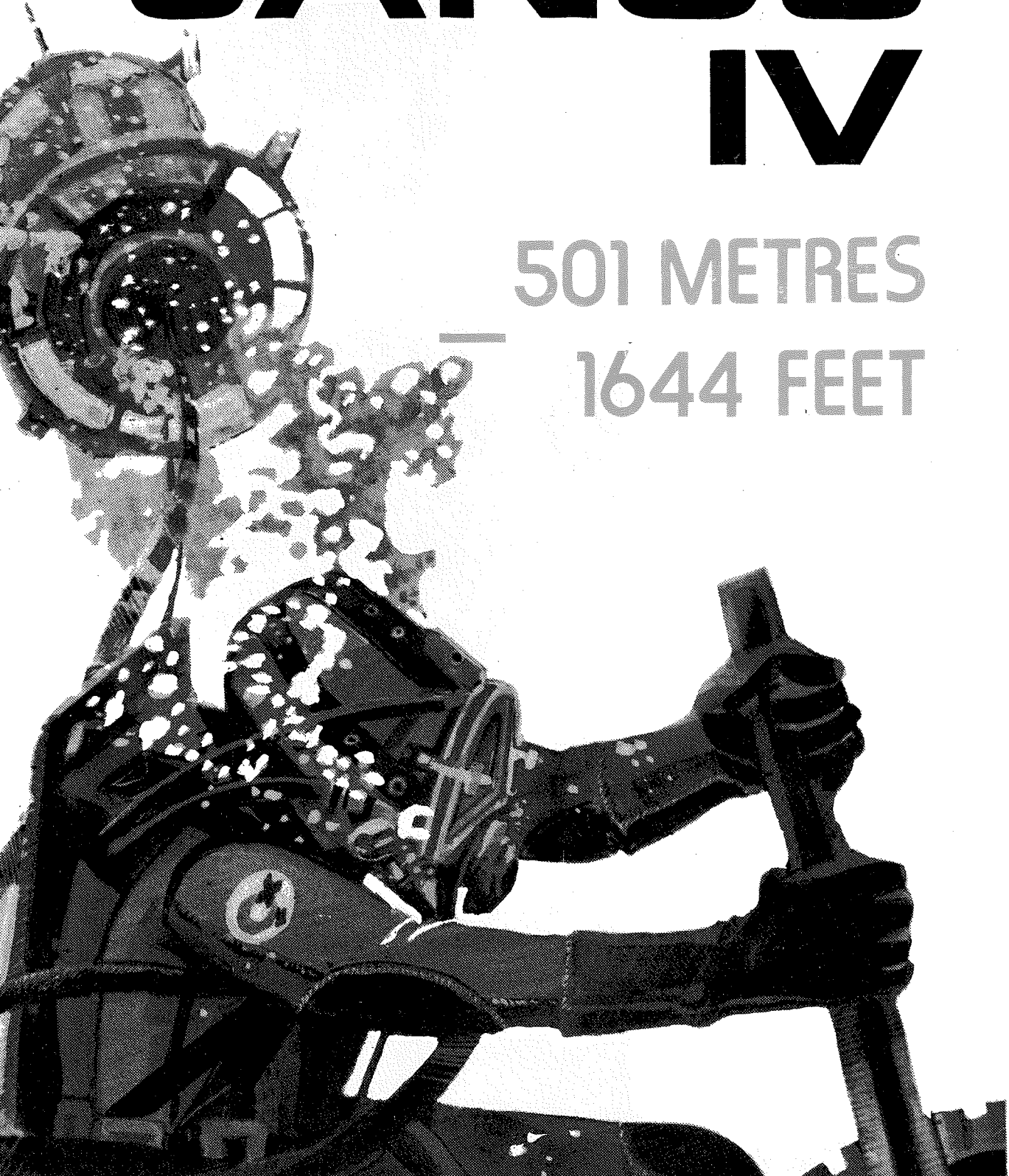

" J A N U S I V "

TABLE OF CONTENTS

<u>INTRODUCTION</u>	p 1.
<u>BACKGROUND</u>	p 2.
I - COMEX RESEARCH PROGRAM : HYPERBARIC EXPERIMENTS	p 2.
II - SUMMARY OF PRECEDING "JANUS IV" EXPERIMENTS	p 4.
<u>GENERAL PLAN OF OPERATION "JANUS IV"</u>	p 6.
<u>PHASE I : DIVER SELECTION</u>	p 7.
<u>PHASE II : DRESS REHEARSAL</u>	p 10.
I - DESCRIPTION	p 10.
II - RESULTS AND CONCLUSIONS	p 17.
(A) PHYSIOLOGICAL ASPECT	
(B) NEUROPHYSIOLOGICAL ASPECT	
(C) INDIVIDUAL EQUIPMENT	
(D) CONCLUSION	

PHASE III : DEEP SEA OPERATION

I	- INTRODUCTION	p 27.
II	- GENERAL ORGANIZATION OF PROJECT "JANUS IV"	p 29.
III	- OPERATIONAL PERSONNEL REQUIRED	p 31.
IV	- EQUIPMENT	p 37.
	(A) SURFACE EQUIPMENT	p 38.
	(B) DIVING EQUIPMENT	p 50.
	(C) WORK EQUIPMENT	p 59.
V	- SCHEDULE OF ACTIVITIES FOR THE PERIOD FROM 15 OCTOBER TO 29 OCTOBER	p 92.
VI	- COMPRESSION PHASE	p 110.
VII	- DIVING PHASE	p 115.
VIII	- DECOMPRESSION PHASE	p 143.
IX	- RESUME	p 150.
	(A) SUMMARY OF DIVES	p 150.
	(B) GAS CONSUMPTION	p 154.
	(C) PHYSIOLOGICAL REPORT	p 156.
	(D) UNDERSEA WORK RESULTS	p 159.
	<u>CONCLUSION</u>	p 171.

I N T R O D U C T I O N

I N T R O D U C T I O N

The CENTRE NATIONAL POUR L'EXPLOITATION DES OCEANS (C.N.E.X.O.), COMPAGNIE MARITIME D'EXPERTISES (COMEX) and the FRENCH NAVY (GISMER & DRME) carried out a diver lockout operation at 501 meters (1644 feet) depth, with COMEX in charge, called Operation "JANUS IV".

This took place off CAP BENAT in the MEDITERRANEAN SEA between October 15th and 29th 1977, from the dynamically positioned drill ship "PETREL" which was generously put at the disposition of the project by the ELF-AQUITAINE Group.

The purpose of the operation was to prove :

- . that it is possible for human beings to descend in the sea to a depth of 501 meters, or 1644 feet ;
- . that at this depth it is possible for them to perform work such as is regularly done now in the 700 feet range (200 meters) and exceptionally in the 1000 feet range (300 meters).

- 3 JAN. 1978

JANUS IV

B A C K G R O U N D

B A C K G R O U N D

- I - COMEX RESEARCH PROGRAM ; HYPERBARIC EXPERIMENTS

"JANUS IV" is the logical sequel to the series of hyperbaric experiments performed by COMEX since 1965.

This hyperbaric research program has been crystallized in three series of experiments :

- . the "**PHYSALIE**" experiments,
a series of simulated dives to record depths for very short periods of time, constituting pressure highs never before attained.
- . the "**SAGITTAIRE**" experiments,
consisting of prolonged sojourns at the record pressure depths established during the PHYSALIE experiments.
- . finally, the "**JANUS**" experiments,
the purpose of which was to transpose human intervention at great depths to the sea itself, in actual operating conditions.

All of the "PHYSALIE" and "SAGITTAIRE" dives were substantiated by extensive physiological, psychological and biological studies on the basis of which it was possible to rigidly define the compression and decompression procedures and control of the environmental parameters such as breathing mixtures, temperature, relative humidity, etc.

Research on equipment was being conducted at the same time, and the synthesis between equipment and method was made with the "JANUS" deep sea experiments.

The following depths were reached during the PHYSALIE experiments :

. 520 meters in 1970 (1700')
PHYSALIE V

then

. 610 meters in 1972 (2001')
for 1 hr. 20 mins.
PHYSALIE VI

During the last SAGITTAIRE experiment, SAGITTAIRE IV, in 1974, divers remained at a pressure depth of 610 meters for 50 hours.

Given the results of this research and of these experiments, it was decided in September 1976 to proceed with Operation "JANUS IV" to attain the real sea depth of 460 meters.

- II - SUMMARY OF THE PRECEDING "JANUS" EXPERIMENTS

- "JANUS I" - October 1968

JANUS I was the first saturation dive ever carried out in the sea.

At a depth of 150 meters (500 feet) in the Cassidaigne Trough off Cassis, France, two two-man teams worked successfully on an offshore wellhead. The saturation for each team lasted six days.

This world "first" was jointly sponsored by ELF, COMEX and the FRENCH NAVY.

- "JANUS II" - October 1970

This operation, which was conducted according to the methods developed for "JANUS I", represented a veritable leap forward as regards human penetration and working capabilities in the sea.

In the Bay of Ajaccio, Corsica, three COMEX divers worked twice a day on a base plate at -253 meters (830'), constituting a life-sized subsea worksite on which they successfully performed pipeline cutting and welding operations.

In the course of a week thirteen dives were made, totaling more than 26 hours of bell bottom time and 35 hours of diver lock-out time. JANUS II had proven that specially trained and equipped men could work effectively at a depth of 830 feet.

- "JANUS III" - April 1975

This operation consisted essentially of a series of simulated wet dives with work programs in a hyperbaric pool pressurized to the equivalent of 390-450 meters (1280-1475 feet) in the COMEX hyperbaric research complex EMS 600 at Marseilles.

The purpose of this experiment was :

- . to verify certain physiological and ergonomic data
- . to perfect the individual diving equipment required for sea diving at these depths.

GENERAL PLAN OF OPERATION "JANUS IV"

GENERAL PLAN OF OPERATION "JANUS IV"

In September 1976 it was decided to proceed with Operation "JANUS IV" in three separate phases :

Phase I : selection of participating divers from among those who volunteered, by means of various tests.

Phase II : dress rehearsal for the deep sea operation in similar living and working conditions.

Phase III : the deep sea operation itself.

Made possible by ELF-AQUITAINE's loan of the dynamically positioned drill ship 'PETREL", the JANUS IV Operation was scheduled from the beginning to cover more than a year, as follows :

Phase I : October 1976

Phase II : December 1976

Phase III : October 1977

PHASE I

DIVER SELECTION

P H A S E I

- DIVER SELECTION

The purpose of the first phase, in October 1976, was to detect any physiological and clinical inaptitudes or to discern the varying degrees of inaptitude in a number of candidates. More than twenty prescreened volunteers underwent a series of seven tests at depths in the 180-210 meter range (590-690 feet).

In addition to the routine compulsory medical examination, these tests were designed to evaluate :

- . sensitivity to compression, by clinical observation of the following symptoms : tremor, dizziness, nausea, dysmetria and high pressure articular syndrome.
- . sensitivity to high pressure, by means of the electroencephalograph (E.E.G), which objectifies the occurrence of the slow waves characteristic of H.P.N.S. (High Pressure Nervous Syndrome).
- . alertness, by means of psychosensory tests of, for instance, visual choice reaction time, and intellectual tests such as arranging number sequences and sign selection. The results of these tests were correlated with E.E.G. results and pulse rate measurements.
- . manual dexterity, by a test of the ability to arrange and insert pegs in holes.

- . physiological function study, by measurement of cardio-respiratory adjustment to physical exertion, of ventilatory mechanics, vital capacities, electrical impedance and air bubble detection.
- . biological reaction, as measured by urinalysis.
- . self-evaluation capacity, measured by questionnaires filled in by the divers themselves concerning their own situation and condition.

This set of tests made it possible to compare the performances of the diver candidates and, more importantly, to evaluate their fitness for very deep diving and for the type of work liable to be required at such depths.

This mode of selection was chosen as a result of previous observations. High Pressure Nervous Syndrome (H.P.N.S.) can appear as early as 180 meters (590') during very rapid compression (a few minutes). It may be more or less pronounced depending on individual susceptibility.

The divers participating in the very deep simulated dives of PHYSALIE V (-520 m), PHYSALIE VI (-610 m) and SAGITTAIRE II (-500 m) had first made bounce dives to -180 meters under neurophysiological control.

During the course of the very deep dives the diver who displayed the most intense symptoms, which almost interrupted the dive, was the one who had presented significant E.E.G. changes at -180 m during the bounce dives.

During the Phase I selection, eleven divers exhibited no tremor, four had slight tremor, two had more pronounced tremor. But even in the last two the level of tremor

remained relatively low, since it did not exceed 100% increase.

Consequently it may be considered that the candidates did not exhibit tremor which could handicap them in manual work.

The E.E.G. changes recorded necessitated setting up four categories of classification :

- . the first comprising divers who exhibited no electro-encephalographic disturbance and for whom there was no selection problem.
- . the second composed of divers whose E.E.G. showed very slight modification and for whom it might be presumed that there would be no further change or that any further change would be slight enough to permit them to continue the dive without trouble.
- . the third composed of divers whose E.E.G. showed significant changes at -180 meters, sometimes more intense than those observed in others during much deeper dives, for whom it was reasonable to suppose the E.E.G. disturbances would be further aggravated at greater depths, possibly compromising the experiment.
- . The divers in this category, and therefore necessarily those in the fourth category, could not be retained for this experiment.

To avoid the danger of pronounced H.P.N.S. between 400 and 460 meters, only divers in E.E.G. groups 1 and 2 were selected.

PHASE II

"DRESS REHEARSAL"

P H A S E I I

- DRESS REHEARSAL

In December 1976 a "dress rehearsal" was conducted in the COMEX modular hyperbaric complex EMS 600 at the same depth (460 meters / 1510 feet) as the deep sea operation planned for the following year. The purpose of the dress rehearsal was :

- . to accustom the divers selected in Phase I both physiologically and psychologically to such conditions, and to test their reactions.
- . to test the equipment at this depth and make any modifications required.
- . to adapt the equipment to the personnel.

During this phase the eight FRENCH NAVY and COMEX divers who had been selected lived for eight consecutive days at a pressure corresponding to a depth of 400 meters, or 1310'.

From this living depth working dives were made in a special pressurized pool to depths of 430, 445, 460 and 480 meters / 1410, 1460, 1510 and 1575 feet, respectively.

During the first two days six dives representing a total 9 hrs. 15 mins. of work demonstrated the divers' ability to work effectively in 430 meters (1410 feet) of water at 4°C (39° F).

PLAN VIEW.

EMS 600 Hyperbaric System

Supplementary System

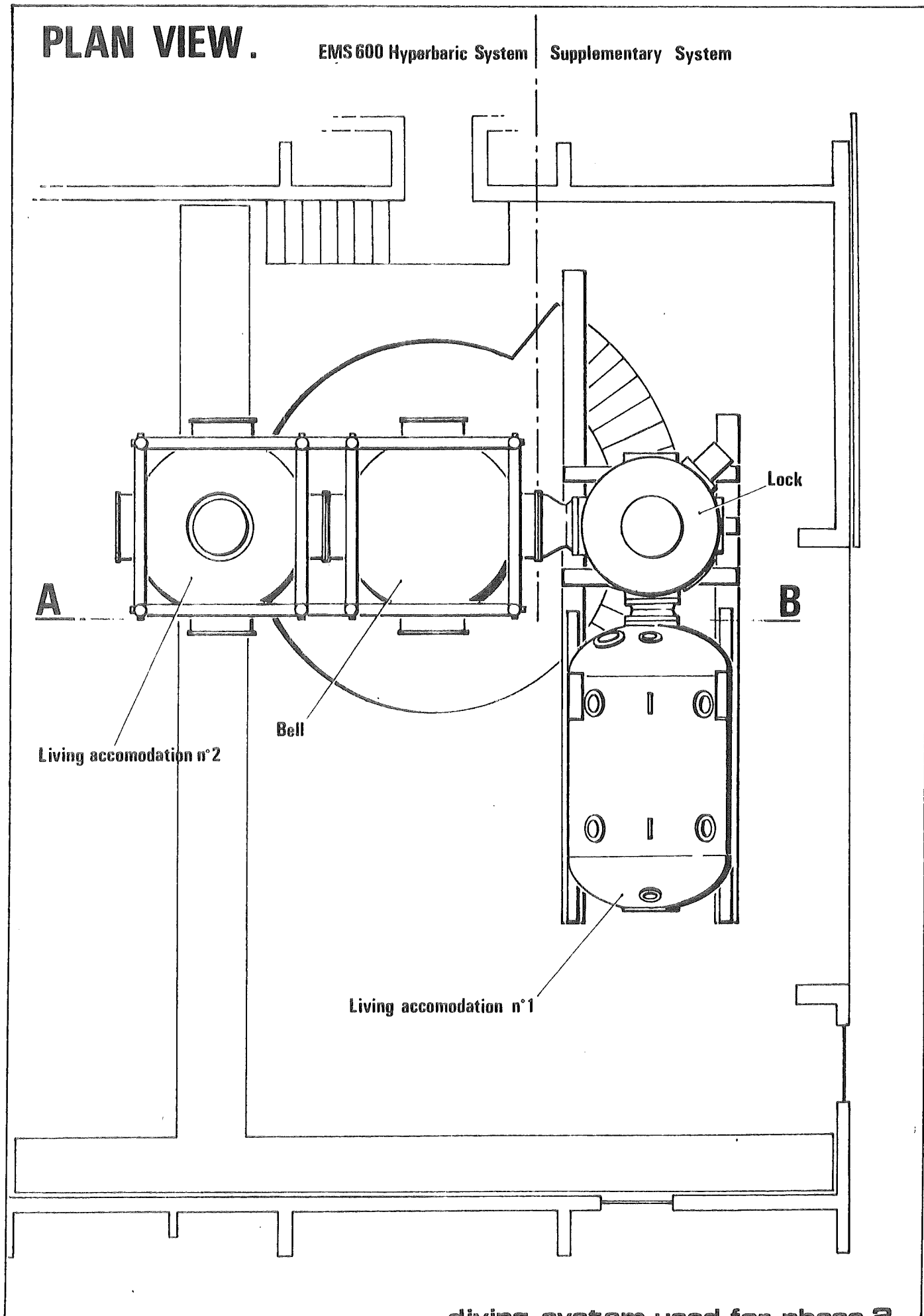

diving system used for phase 2

CROSS-SECTIONAL. View A-B

EMS 600 Hyperbaric System

Supplementary System

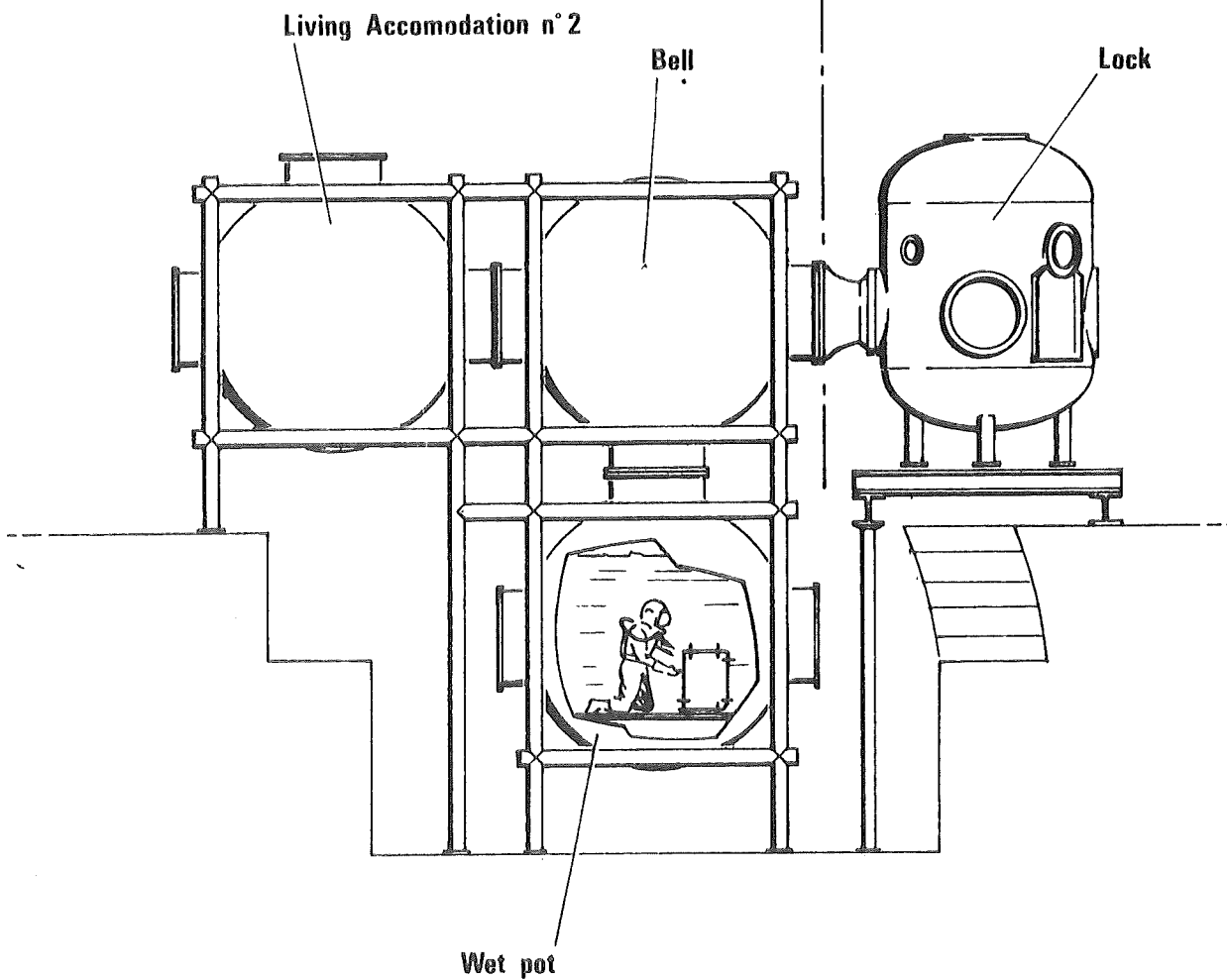

diving system used for phase 2

Four additional work dives were made to -445 meters (1460 feet) for a total of nearly five hours.

In order to simulate the depth goal of the sea phase of "JANUS IV" there were then twelve work dives over a three-day period, for an effective total of 12 hours 15 minutes at 460 meters (1510 feet).

Finally, a last dive to an unprecedented -480 meters (1575 feet) was made for 10 minutes in 6°C (43° F) water.

JANUS IV

DECEMBRE 1976

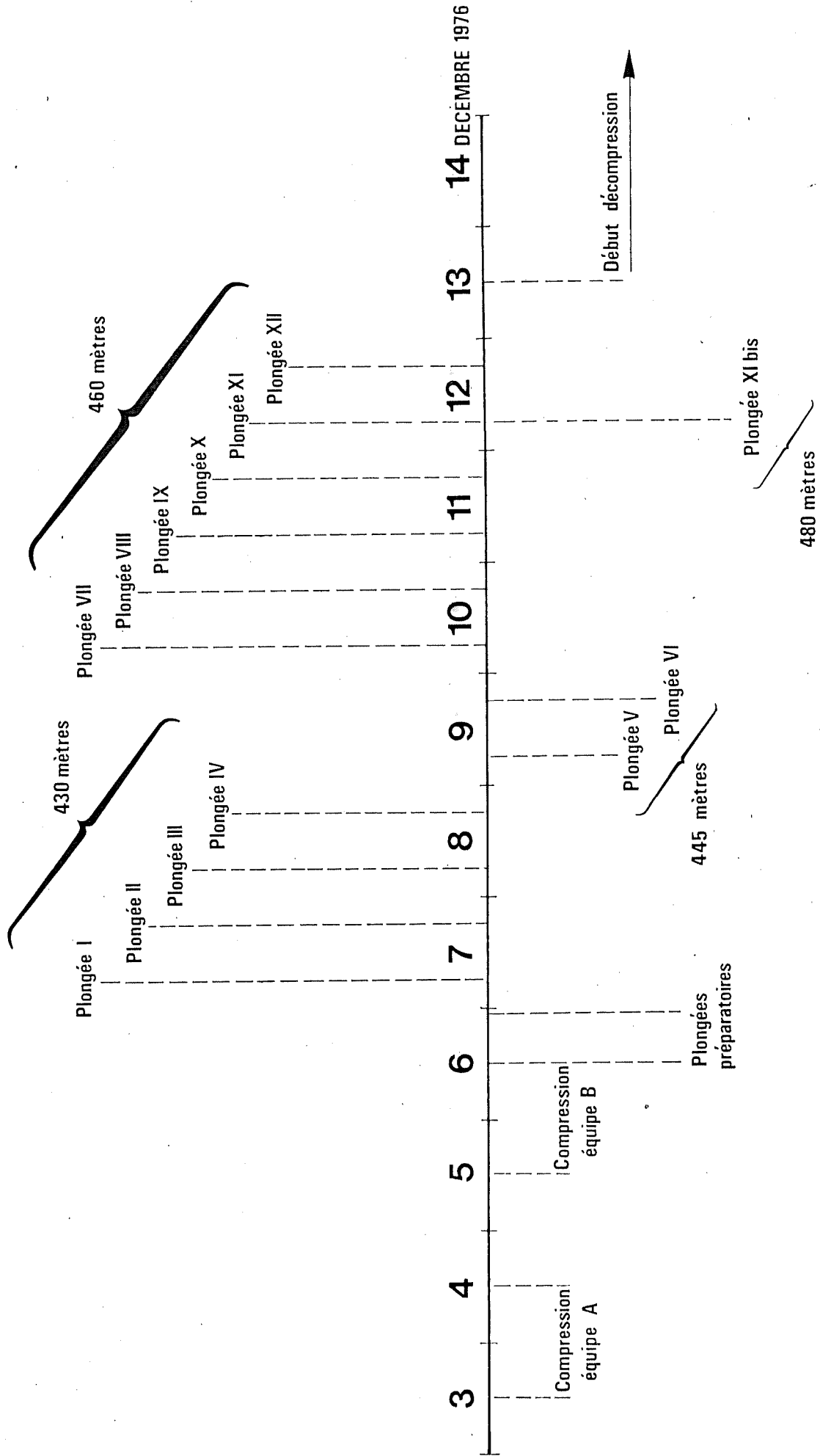

JANUS IV

DECEMBRE 1976

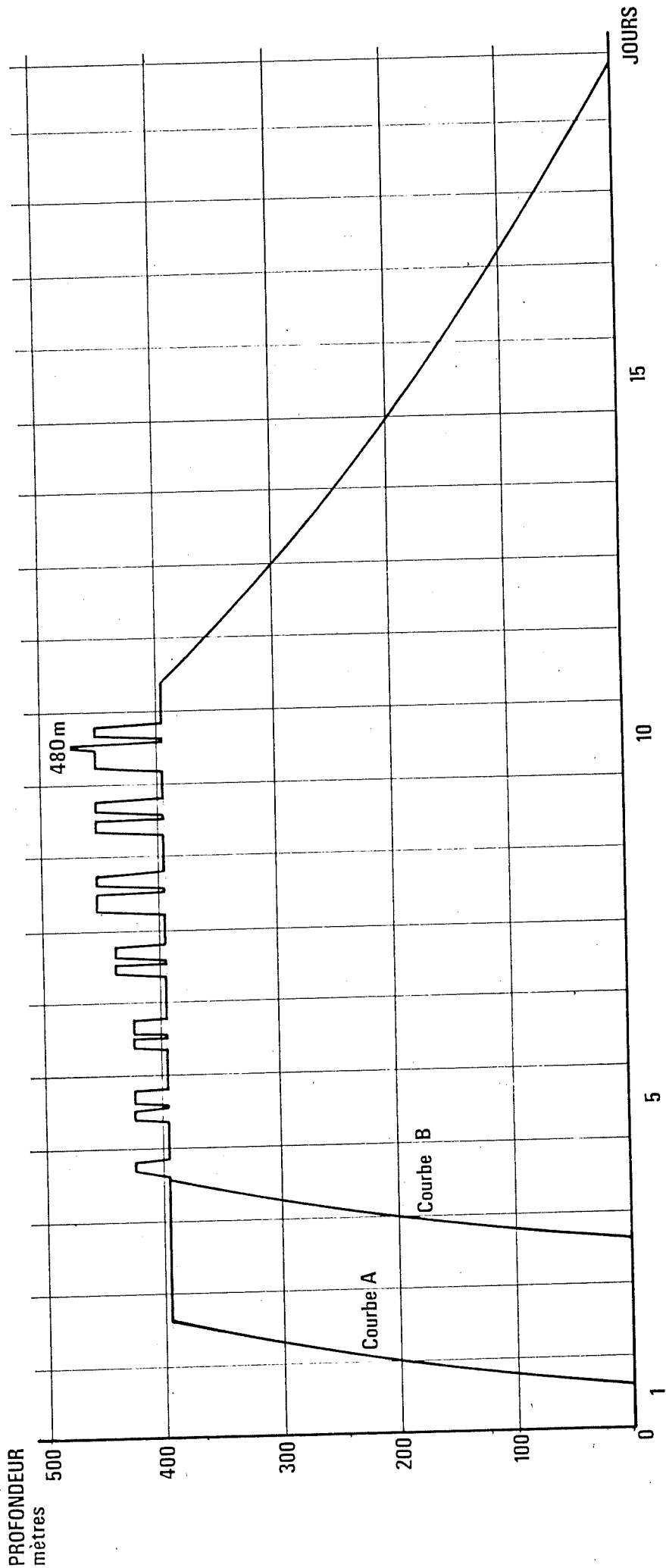

SUMMARY OF THE DIVES

TIME ACTUALLY SPENT IN WATER

0h26	1h50+2h32	1h07 0h59 0h58 + 1h53	0h04 1h24 1h33 + 0h55	1h 1h07 0h24 + 2h02	0h56 1h03 1h10 + 0h57	0h48+0h10 1h03 0h48 + 0h58	25h4
------	-----------	--------------------------	--------------------------	------------------------	--------------------------	-------------------------------	------

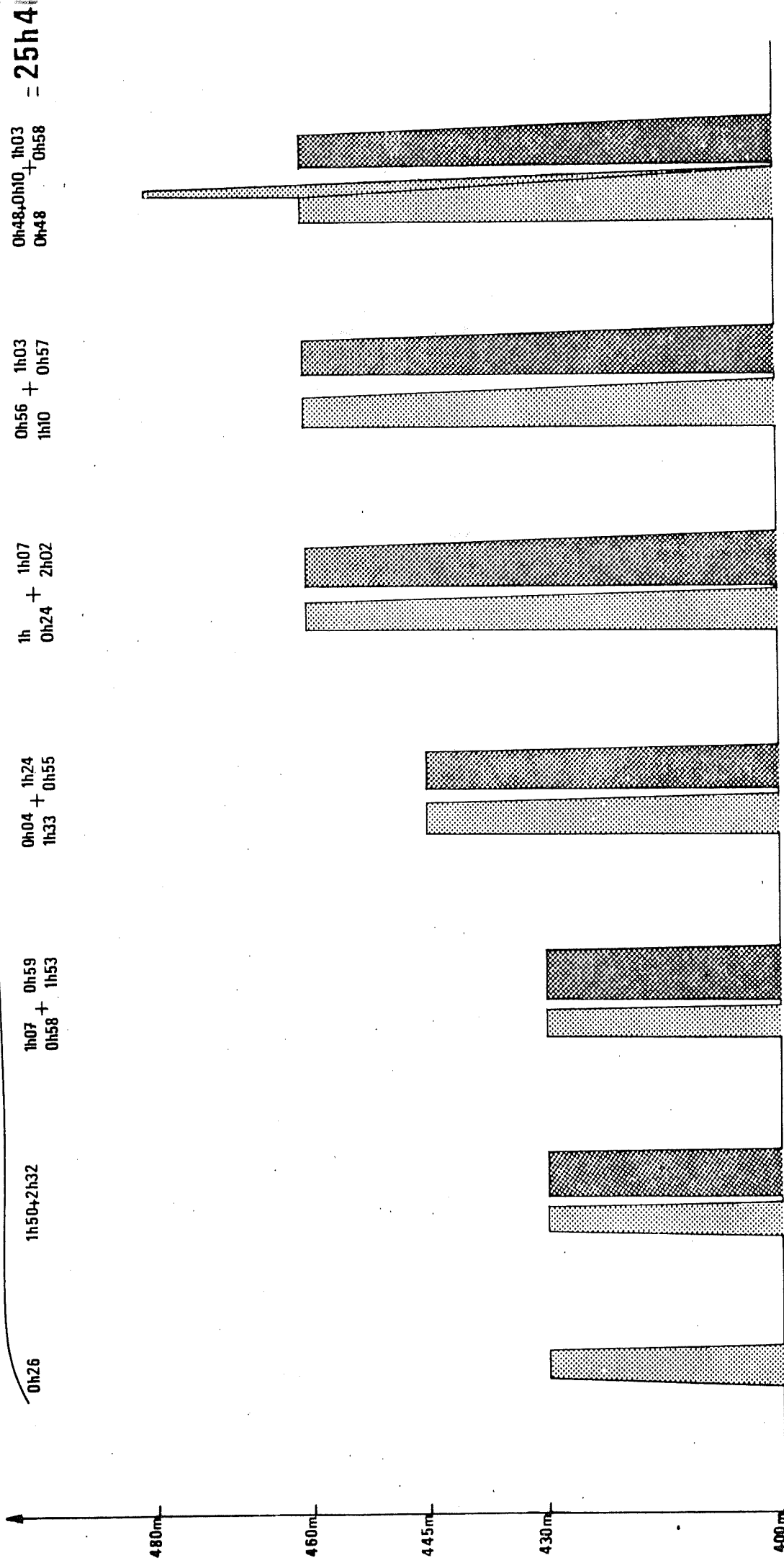

TOTAL DURATION OF THE DIVES = 67h57 = 25h4 DAYS

- RESULTS AND CONCLUSIONS OF PHASE II

I - THE PHYSIOLOGICAL ASPECT :

The work accomplished by the divers confirmed that these depths had no effect on their :

- manual dexterity
- ability to reason
- physical strength

This was shown by means of the work task assigned them : assembling and tightening up a "puzzle" of 20 two-inch flanged pipe sections.

II - THE NEUROPHYSIOLOGICAL ASPECT

The medical research conducted during Phase II of JANUS IV was oriented toward the detection of H.P.N.S. symptoms and observation of their development at different diving stages :

- during compression from 0 to 400 meters
- at the 400-meter stop
- during the 430-, 445-, and 460- meter excursion dives
- during final decompression.

The research concentrated on tremor and electroencephalogram symptoms.

A) Methods :

1 - Tremor

Tremor was recorded during the "Oath" test by a Geospace HS-J postural tremor device placed on the second finger of the right hand.

This test was conducted several times a day during the divers' confinement in order to obtain an average for 24 hours. It was performed at different depth levels during compression, morning and evening during the 400-meter stop, and during compression for the excursion dives.

The signals, recorded on analog tape, were later processed by a PDP LAB 11/10 computer to obtain the average amplitude of the signals, their maximum power and frequencies.

2 - Electroencephalogram

ECEM electrodes were placed on specific points on the right side of the scalp : fronto-polar, central, central mid-temporal, temporal and occipital regions. The electrodes were held in place by gauze and collodion.

The eye movements were registered by means of "capsulex" electrodes placed on either side of the eyes by the divers themselves and held in place during the night by adhesive tape.

The E.E.G. was recorded by means of twin bipolar derivations. The activity was transcribed on ALVAR electroencephalographs and each sequence recorded and numbered on analog tape.

After the electroencephalogram has been read, the sequences selected are processed by a PDP LAB 11/10 computer to obtain

the E.E.G. energy spectrum. The computations are made on the average spectra obtained by averaging the unitary spectra corresponding to a single state (awake or asleep) for the same series of tests.

The E.E.G. was taken when the divers were resting, with the eyes either open or closed, and during intellectual tasks.

B) Results obtained :

1 - Tremor

The method of compression that was used did not produce any significant increase in tremor.

2 - E.E.G. Modification

a) during compression -----

The first E.E.G. changes that occurred during compression appeared between 180 and 240 meters, and attained their peak between 240 and 300 meters in both groups of divers. These changes were characterised by :

- an increase in slow frequency E.E.G. activities, particularly in the theta band on the frontal and/or middle regions.
- tracings indicating Stage I sleep. In Group I deep sleep stages were observed in the middle of the afternoon when the divers had a rest between 200 and 300 m.

In general the energy spectra show an increase in theta activity during compression, with the peak between 240 and 300 meters for both groups of divers.

In Group I the increase varied from 200 % in the least susceptible subjects to 1200 % in those whose curves showed the greatest degree of disturbance.

In Group 2 the increase in theta band activity oscillated from 400 % to 1300 % according to the subject.

Between 370 and 400 meters E.E.G. changes in 7 out of the 8 divers were less than during the first phase of compression.

Parallel to the increase in slow frequency activity, either an increase in faster frequencies (alpha and beta bands) or a depression in the same bands was observed. Where the rapid frequency activity was accentuated it was found to vary from 200 % to 800 % according to the subject.

b) during the 400 meter stop

Theta band activity persisted at a fairly high level (200 % to 800 %) during this stop, with, however, a slight regression of the phenomenon in some subjects toward the end of the stop.

Fast frequency activity (alpha and beta bands) also persisted during the stop, but was less marked than during compression.

c) during excursion dives

For equal depths there was greater increase in theta activity during the first excursion dives than during the last ones.

- excursions from 400 to 430 meters :

There was no significant change during the first excursion dive to 430 meters (compression time 1 hour).

During the subsequent ones with faster compression, on the other hand, 6 divers out of 8 exhibited an increase

INCURSION DIVE COMPRESSION PROFILES

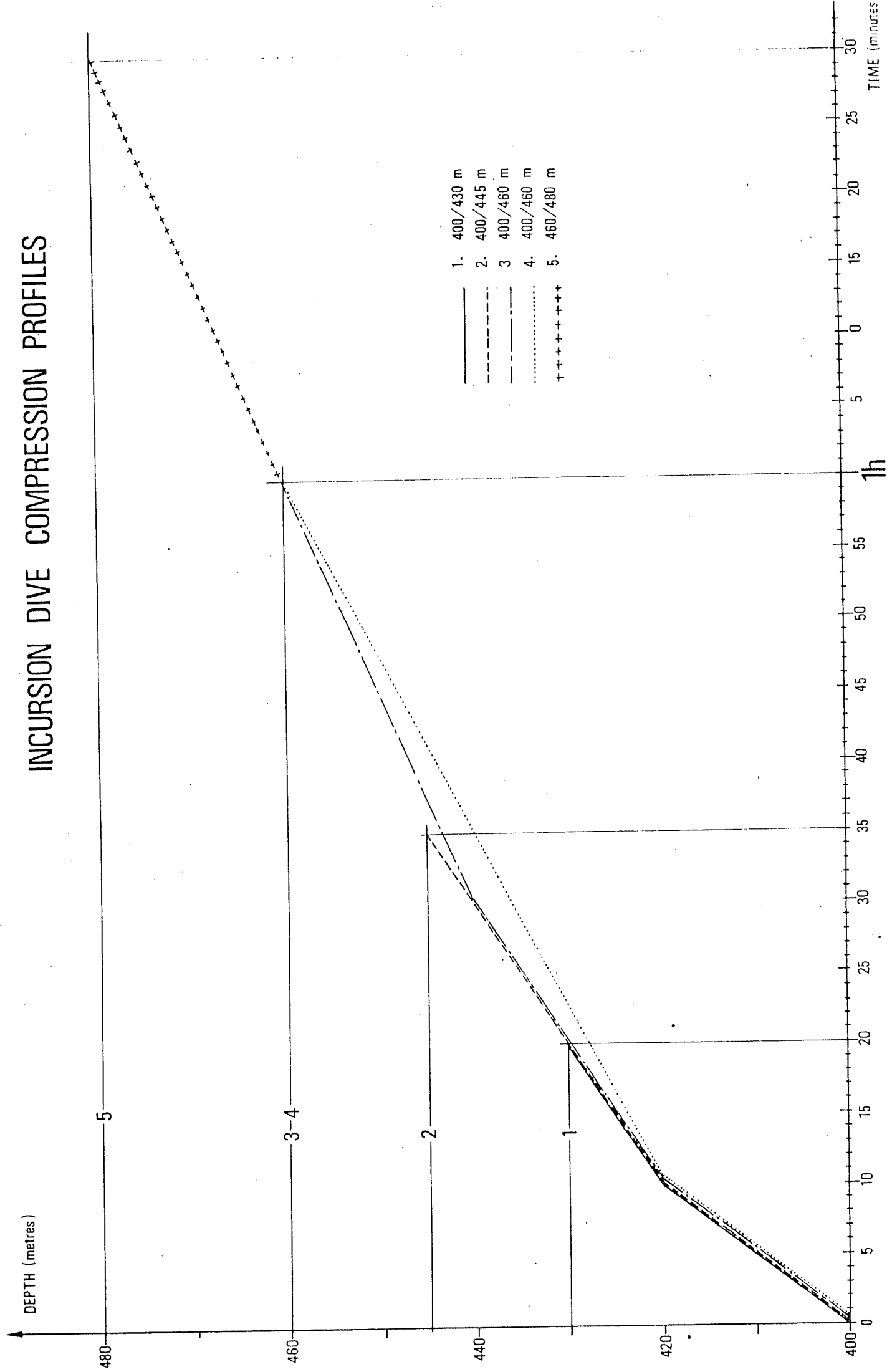

- 1. 400/430 m
- 2. 400/445 m
- 3. 400/460 m
- 4. 400/460 m
- 5. 460/480 m

DEPTH (metres)

TIME (minutes)

480

460

440

420

400

5

3-4

2

1

0

5

10

15

20

25

30

35

40

45

50

55

1h

0

5

15

20

25

30

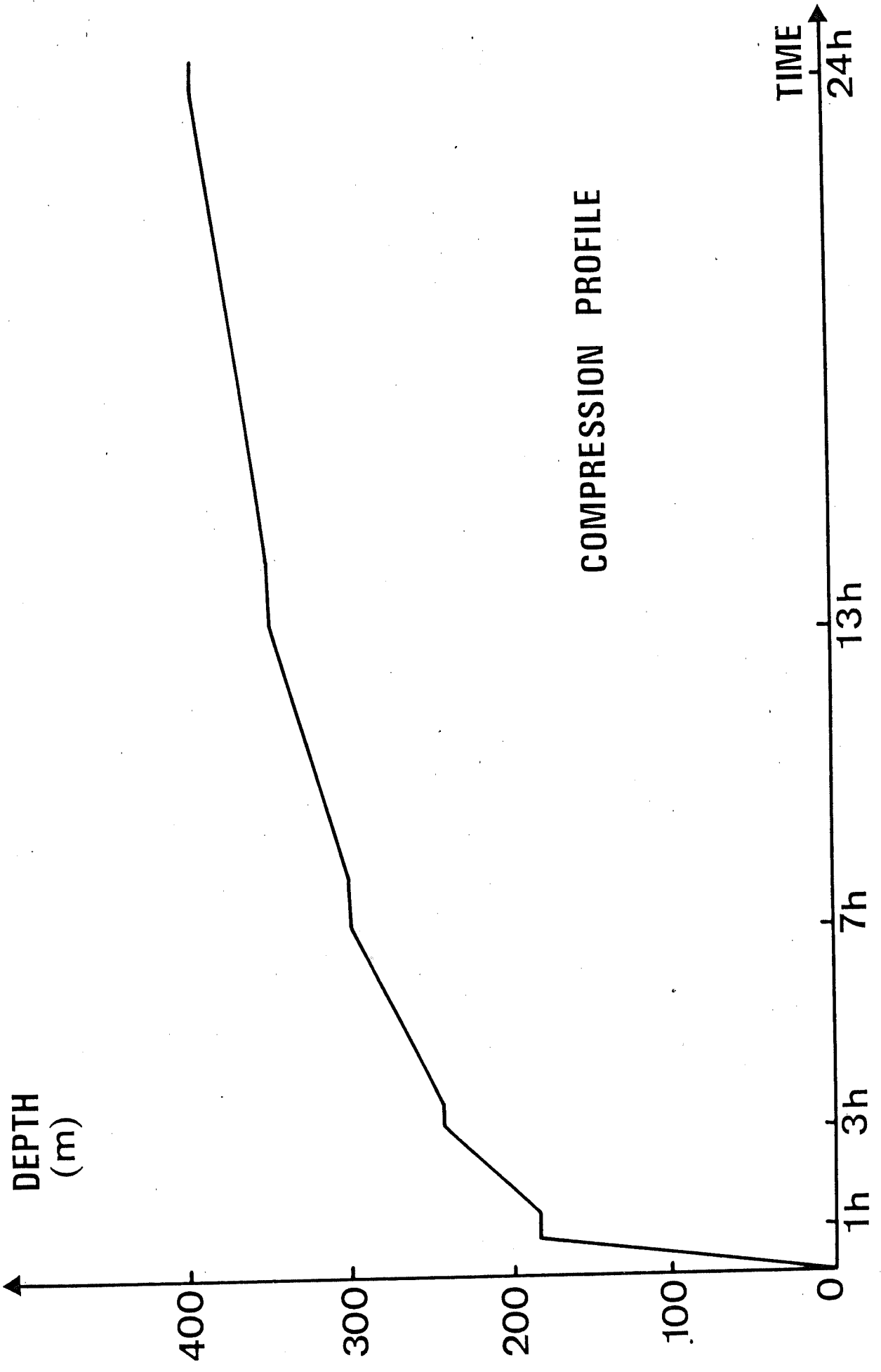

INCURSION DIVE DECOMPRESSION PROFILES

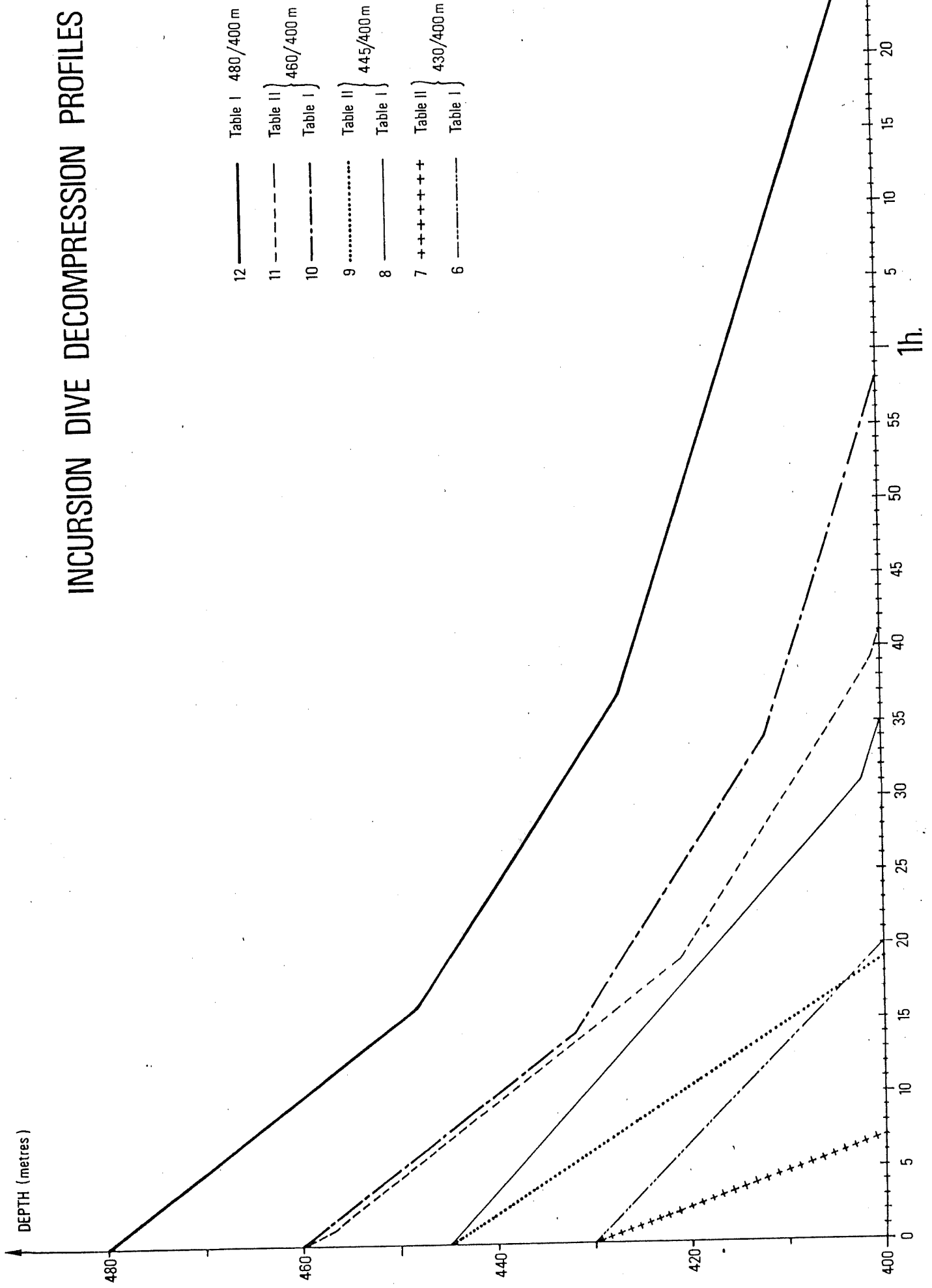

FINAL DECOMPRESSION SCHEDULE

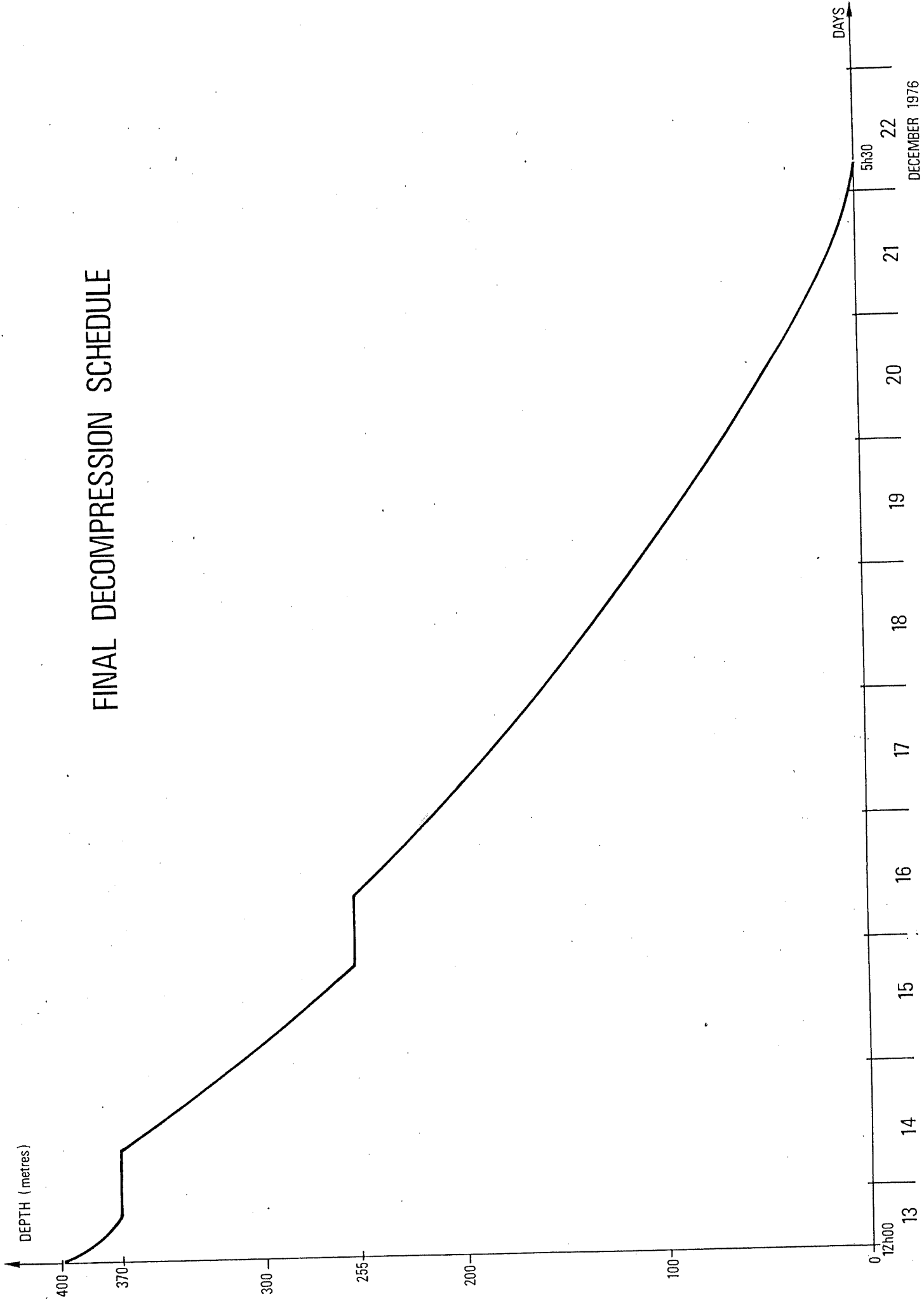

in theta frequency activities of 100-300 % compared to the reference level prior to the dive, on the frontal and/or middle regions.

- excursions from 400 to 445 meters :

During these excursions Group 1, which had already made two excursions to 430 meters, exhibited no significant change relative to the curves at 400 meters. In Group 2, however, which had made only one dive to 430 meters, three divers' curves indicated an increase of theta activity on the order of 100 to 300 %.

- excursions from 400 to 460 meters :

Increase in theta activity was observed in 6 divers out of 8 during the first excursion dives to 460 meters. They varied according to subject from 100 % to 300 % and were most pronounced from 445 meters on. The variation was less systematic during the last excursions to 460 m, affecting only 3 out of the 6 divers who originally exhibited them.

- During the excursion from 460 to 480 meters there was an increase in theta activity of from 100 to 300 % relative to the 460-meter level.

III- WITH RESPECT TO INDIVIDUAL EQUIPMENT :

Dives in water whose temperature varied from 2° to 7° C. also confirmed that the individual diving equipment, such as hot water diving suits and breathing gas heaters, was operational at depths down to 480 meters (2°-7° C = 36° - 45°F).

IV - CONCLUSION :

Phase II of Project JANUS IV thus resulted in final selection and preparation of six physically, psychologically and

physiologically fit divers, and in confirmation of the validity of the equipment for the final phase of the project.

PHASE III
DEEP SEA OPERATION

P H A S E I I I

(DETAILED TABLE OF CONTENTS)

- <u>INTRODUCTION</u>	p 27.
- <u>GENERAL ORGANIZATION OF PROJECT "JANUS IV" AS REGARDS THE CONVENTIONS BINDING THE DIFFERENT SPONSORS AND PARTICIPANTS.</u>	p 29.
- <u>OPERATIONAL PERSONNEL REQUIRED FOR PROJECT "JANUS IV"</u>	p 31.
A) ALPHABETICAL LIST OF THE MEMBERS OF THE SURFACE OPERATIONAL TEAM ABOARD THE "PETREL".	p 33.
B) ALPHABETICAL LIST OF SATURATED DIVERS	p 34.
- <u>EQUIPMENT</u>	p 37.
A) SURFACE EQUIPMENT	p 38.
1 - Chambers	
2 - Regeneration system	
3 - Environmental control of hyperbaric life parameters.	
4 - Communications.	
B) DIVING EQUIPMENT	p 50.
1 - Diving bell	
2 - Bell handling system	
3 - Diving gas recovery system	
4 - Diving gas	
5 - Individual diving equipment	

C) WORK EQUIPMENT	p 59.
1 - Possible formulae for setting the Comector	p 60.
2 - Main features of the work table designed for "JANUS IV"	p 62.
3 - The Comector	p 74.
4 - Procedure for installing a Comector	p 77.
5 - Procedure for setting the Comector in the event of hydraulic power failure.	p 79.
6 - Equipping the work table prior to lowering it to 460 meters.	p 81.
7 - Precautions to be taken with hydraulic equipment while work table is being lowered.	p 83.
8 - Hydraulic check list prior to beginning work at 460 meters.	p 85.
9 - Procedure for using the pipe-cutter	p 86.
- SCHEDULE OF ACTIVITIES FOR THE PERIOD FROM 15 OCTOBER TO 29 OCTOBER	p 92.
<hr/>	
I - SATURATION PROGRAM	p 92.
II - SCHEDULE FOR LAUNCHING AND LOWERING THE WORK TABLE	p 104.

- <u>COMPRESSION PHASE</u>	p 110.
- <u>DIVING PHASE</u>	p 115.
I - GENERAL REPORT	p 115.
II - CHECK LIST BELL INTERIOR	p 136.
III - CHECK LIST BELL EXTERIOR	p 140.
IV - EMERGENCY PROCEDURES	p 141.
- <u>DECOMPRESSION PHASE</u>	p 143.
- <u>RESUME</u>	p 150.
I - SUMMARY OF DIVES	p 150.
II - GAS CONSUMPTION	p 154.
III - PHYSIOLOGICAL REPORT	p 156.
A) VITAL CAPACITY	
B) BLOOD ANALYSIS	
IV - UNDERSEA WORK RESULTS	p 159.
A) WELDING AND OXYARC CUTTING	p 160.
B) 8" PIPE CONNECTION WITH COMECTOR	p 166.

PHASE III
INTRODUCTION

P H A S E I I I

- INTRODUCTION

Phase III, the deep sea diving operation, took place from October 15th to 29th, 1977, in the Mediterranean. After survey missions in the FRENCH NAVY submarine "GRIFFON" the site chosen off the coast of Cavalaire was :

43° 07' 26" North
06° 31' 42" East

The depth of the bottom was 501 meters, the visibility 15 meters and the water temperature 13.2°C.

A considerable number of personnel and extensive equipment were required for the operation. These factors are dealt with in the following pages.

This is followed by a description of the operation schedule and an analysis of the compression tables, living or storage level stops, dives and decompression.

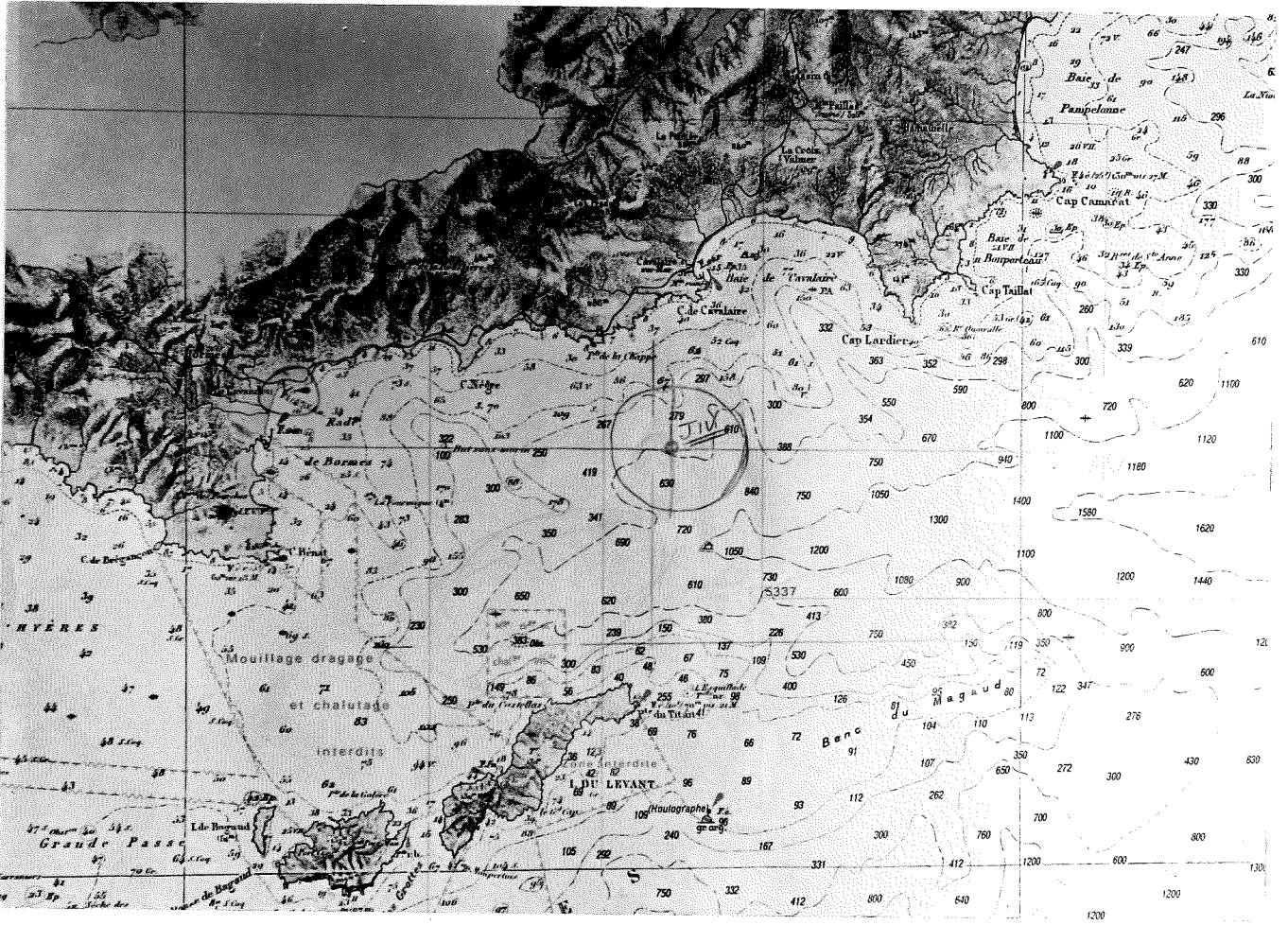

SITE CHOSEN FOR SEA OPERATIONS

P H A S E I I I

GENERAL ORGANIZATION OF PROJECT "JANUS IV"

- GENERAL ORGANIZATION OF PROJECT "JANUS IV" AS REGARDS THE CONVENTIONS BINDING THE DIFFERENT SPONSORS AND PARTICIPANTS.

During a meeting on November 18, 1976, it was decided by the parties concerned to organize the project in accordance with the following general principles :

- The CENTRE NATIONAL POUR L'EXPLOITATION DES OCEANS (C.N.EX.O : French National Oceanographic Commission), the Groupe d'Intervention sous la Mer (GISMER) and the Compagnie Maritime d'Expertises (COMEX) will jointly participate in and conduct Project "JANUS IV" in close cooperation.
- COMEX will be in charge of the Project.
- 4 Committees are established with the following responsibilities :
 - . The Steering Committee, which is the ultimate authority to which are submitted all problems that surpass the prerogatives of the three other committees.
 - . The Operations Committee, which is in charge of :
 - preparation and carrying out of all phases of the operation.
 - individual diving equipment
 - environmental control (saturation)
 - personnel
 - . The Scientific Committee's role is to define diving procedure, therapeutic procedures, physiological measurement and control equipment, and to create a round-the-clock medical watch.

- . The Finance Committee manages the budget allocated to JANUS IV and submits financial reports to the Steering Committee, which is the final authority.

In addition to the above participants, the SNEA (P) Group, or ELF-AQUITAINE by contract put at the disposition of COMEX, for Operation "JANUS IV", the dynamically positioned drill ship "PETREL" and its deep diving system, for a period of five days.

This would allow time for the "PETREL" to reach the site and take up position for the operation, with three days of diving.

This phase was scheduled to take place after the end of COMEX's operations on the wreck of the "BÖHLEN" off Brittany, for which the "PETREL" was the surface support vessel.

P H A S E I I I

OPERATIONAL PERSONNEL

- OPERATIONAL PERSONNEL REQUIRED FOR PROJECT JANUS IV

To ensure the success of the sea operation a certain number of categories of operations personnel were detached to the Project :

- diving superintendents and supervisors
- surface divers for handling the umbilicals, umbilical winches, bell winch, etc.
- worksite technicians
- life support technicians or chamber operators

The personnel were divided into two twelve-hour watches each comprising :

- 1 diving supervisor
- 1 assistant diving supervisor
- 3 surface divers
- 2 worksite technicians
- 2 life support technicians

thus making a total crew of 9 per watch.

In addition to the diving support crew there were :

- a Project Manager in charge of relations with external services and coordination within the group working on the Project.
- a diving superintendent to coordinate the work of the two diving supervisors.
- analysis equipment engineer
- a person in charge of the diving gas recovery system

- an operational doctor
- photography and film technician
- individual equipment engineer

As leader of the project COMEX constituted this team of 25 operationals. In accordance with the agreement among the three partners in the project, COMEX, the French Navy and C.N.E.X.O., four GISMER operationals including one doctor took part in the activities of the COMEX team.

The Steering Committee was represented during the deep sea operation period from October 15th to 20th, 1977, by :

C. BENOIT	Public Relations Director for C.N.E.X.O.
H.G. DELAUZE	President and Chairman of the Board of the COMEX Group
J.C. DUMAS	Director of Diving Research and Development for COMEX
Dr. X. FRUCTUS	COMEX Scientific Director
Commandant GAVARRY	Commanding Officer of Diving Personnel for GISMER
D. GIRARD	Manager of Department D3 at C.N.E.X.O.
Commandant GUYOT	GISMER Officer
J. CORBIER	COMEX Project Manager

A) ALPHABETICAL LIST OF THE MEMBERS OF THE OPERATIONAL TEAM
ABOARD THE "PETREL"

BICCHI	Worksite Technician, COMEX
BIHEL	Life Support Technician, COMEX
BRANCHUT	Diving Superintendent, COMEX
CHUYEN	Worksite Technician, COMEX
COMET	Operational Doctor, COMEX
CORBIER	Project Manager, COMEX
CROZIER	Diving Supervisor, COMEX
CYPRIEN	Assistant Diving Supervisor, COMEX
DE RESSEQUIER	Assistant Diving Supervisor, COMEX
FAYARD	Life Support Technician, COMEX
GAISDE	Surface Diver, COMEX,
GORTAN	Analysis Equipment Engineer, COMEX
GUILLEREY	Life Support Technician, COMEX
HILLION	Telecommunication Technician, COMEX
LE CHUITON	Operational Doctor, FRENCH NAVY
LENTINI	Surface Diver, COMEX
MAC KENNA	Surface Diver, COMEX
MARIE	Officer, FRENCH NAVY
MARY	Individual Diving Equipment Engineer, COMEX
MESUREUR	Surface Diver, COMEX
NAPOLEONI	Worksite Technician, COMEX
NOGUERRA	Diving Supervisor, COMEX
OUZENANE	Life Support Technician, COMEX
PLANQUE	Operational Technician, FRENCH NAVY
POURLIER	Chief Worksite Technician, COMEX
ROQUES	Officer, FRENCH NAVY
SEILLIER	Surface Diver, COMEX
TOCCO	Photography and Film Technician, COMEX
TYMEN	Surface Diver, COMEX

B) ALPHABETICAL LIST OF SATURATED DIVERSJEANTOT PhilippeDate of birth : May 8, 1952Employment : COMEX diver since June 1975Professional record : Very Qualified Diver

1976 : 127 days of saturation, or 3048 hours

1977 : 35 days of saturation, or 840 hours

Performance during Phase II of JANUS IV :

Total diving time : 24 hrs. 37 mins.

Total time in water : 3 hrs. 38 mins.

RAUDE PatrickDate of birth : April 8, 1950Former employment : French Navy combat swimmer,
Bosun's Mate First ClassProfessional record : COMEX diver since March 1974
assistant Diving Supervisor.

1976 : 82 days of saturation, or 1968 hours

1977 : 40 days of saturation, or 960 hours

Performance during Phase II of JANUS IV :

Total diving time : 23 hrs. 35 mins.

Total time in water : 1 hr. 56 mins.

SCHNEIDER LouisDate of birth : March 17, 1951Previous employment : French Navy combat swimmer, Bosun's MateProfessional record : COMEX diver since September 1974
Very Qualified Diver

1976 : 77 days of saturation, or 1848 hours

1977 : 56 days of saturation, or 1344 hours

Performance during Phase II of JANUS IV :

Total diving time : 24 hrs. 06 mins.

Total time in water : 3 hrs. 04 mins.

SEVELLEC Emile

Date of birth : July 12, 1941

Employment : French Navy, Senior Chief Petty Officer

Professional record : 14 years of diving of which 3 years
of deep diving

Performance during Phase II of JANUS IV:

Total diving time : 27 hrs. 59 mins.

Total time in water : 1 hr. 58 mins.

VERPEAUX Jacques

Date of birth : September 19, 1950

Previous employment: Merchant Marine -" Archeonaute" Diver
Training

Employment record : Very Qualified Diver

COMEX diver since June 1975

1976 : 91 days of saturation, or 2184 hours

1977 : no saturation prior to JANUS IV

Performance during Phase II of JANUS IV :

Total diving time : 27 hrs. 59 mins.

Total time in water : 1 hr. 58mins.

VIAL Gerard

Date of birth : March 2, 1945

Employment : French Navy, Chief Petty Officer

Professional record : 11 years of diving of which 7 of
deep diving

Performance during Phase II of JANUS IV :

Total diving time : 28 hrs. 43 mins.

Total time in water : 3 hrs. 26 mins.

PHASE III

EQUIPMENT

JANUS IV

- EQUIPMENT

Three main categories of equipment were used :

- A - The so-called "surface" equipment for maintaining the environmental conditions required for life in saturation : compression chambers, regeneration systems, communications, environmental parameter monitors and controls, gas reserves.

- B- The actual diving equipment : diving bell, individual diving equipment, gas recycling system, diving gas.

- C - The equipment required for the work to be undertaken by the divers during Phase III : the work table, a COMECTOR mechanical connector, umbilicals for supplying power, etc, to the various tools on the work table.

A - SURFACE EQUIPMENT

1) Chambers -----

The hyperbaric complex is composed of three independent compartments connected to one another by clamps, two compression chambers and an intermediate lock.

The lock has four manways, two opening to the exterior and two for clamping to the chambers. These manways are closed by pressure-locking inside doors without windows.

This arrangement permits :

- entry via one of the exterior openings into the chamber control cabin.
- transfer of divers between the lock and the diving bell which clamps onto a horizontal cylinder constituting the second opening to the exterior.
- transfer of divers between lock and chambers.

The respective dimensions are :

Chambers

O.D.	2000 mm
Overall length	3000 mm
Approx. volume	8 cu. m.

Lock

O.D.	1800 mm
Overall height	2000 mm
Approx. volume	4 cu. m.

The rated working pressure for this hyperbaric complex was increased exceptionally to 43 bars after numerous

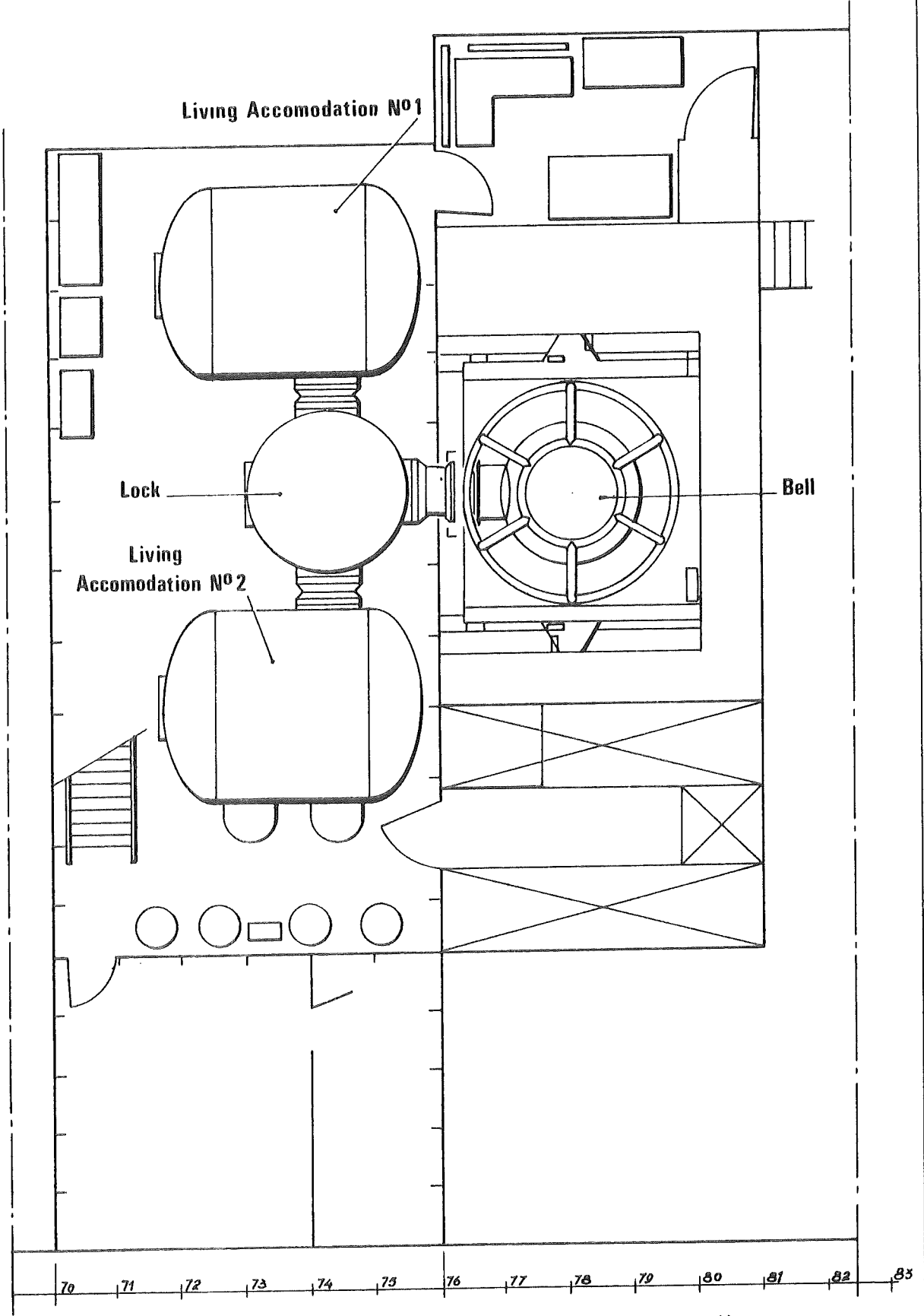

diving system aboard "PETREL"

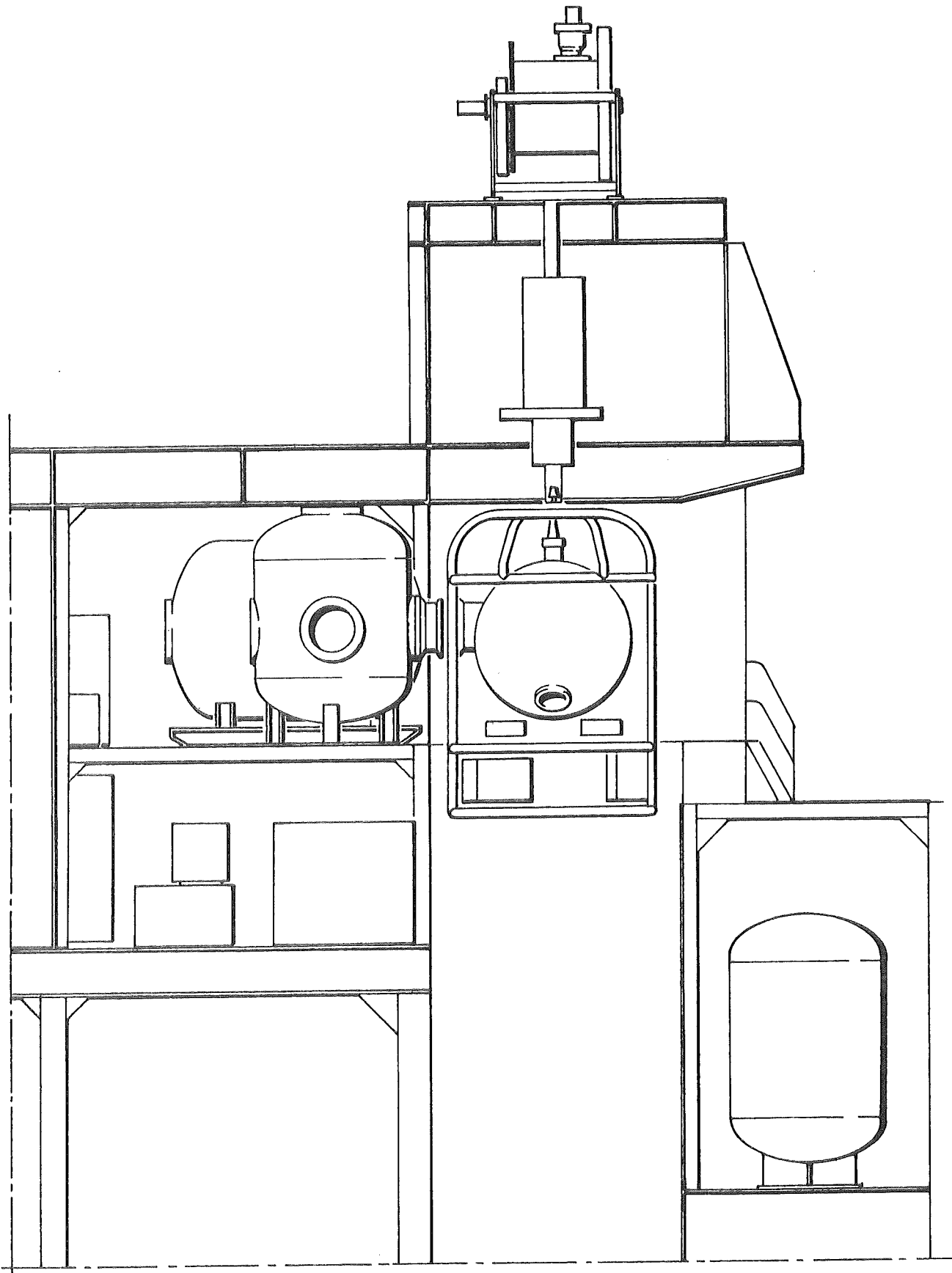

diving system aboard "PETREL"

alterations and testing and after special acceptance by the D.N.V.

Each chamber contains a decompression system, a regeneration circuit and two lighting systems.

The transfer lock has hot and cold water circuits and a waste water drainage system.

2) Regeneration System

The regeneration circuits maintain the proper atmosphere in the compression chambers and the lock, specifically as regards breathing gas composition, relative humidity and temperature.

The system works in closed circuit as follows : the breathing mixture is drawn into the chamber through a soda lime and charcoal filter to scrub CO₂ and eliminate organic particles before entering a booster pump which blows it through a silicagel filter to remove excess moisture, then through a heater and dust filters before discharging it into the chamber.

Each chamber is equipped with an identical, interchangeable regeneration unit.

3) Environmental Control of Hyperbaric Life Parameters

The following parameters were systematically monitored and controlled throughout the operation :

In the chambers :

Pressure

Temperature

Oxygen partial pressure

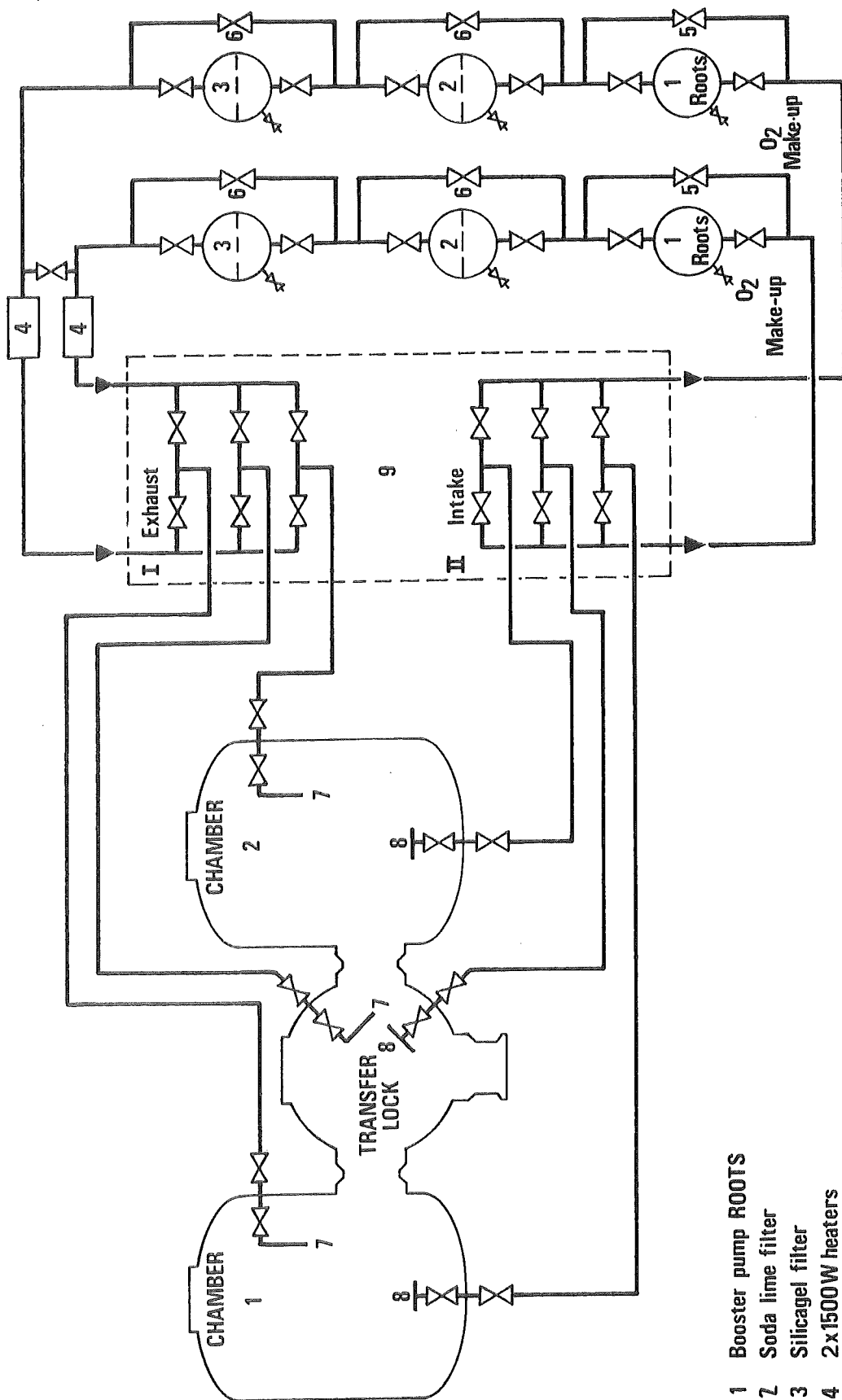

- 1 Booster pump ROOTS
- 2 Soda lime filter
- 3 Silicagel filter
- 4 2x1500W heaters
- 5 Pump by pass
- 6 Filter by pass
- 7 Regeneration Unit Exhaust
- 8 Regeneration Unit Intake
- 9 Control Panel

REGENERATION CIRCUIT

Oxygen content)
 Carbon dioxide content) of the reduced pressure gas
 Nitrogen content)
 Relative humidity

In the bell during dives :

Pressure
 Oxygen content) of the reduced pressure gas
 Carbon dioxide content }

In the recovery circuit for supplying gas to the dives :

Pressure
 Oxygen content) of the reduced pressure gas
 CO₂ content }

The equipment used for this purpose included :

An AEROGRAPH 200 chromatograph with catharometric detector and molecular sifting column for separating the oxygen and nitrogen from the helium.

A SCHLUMBERGER ANIR 12 infrared absorption carbon dioxide analyzer with two scales, 0 to 1000 ppm and 0 to 5000 ppm of CO₂.

Three AOE 2001 digital display oxygen analyzers with galvanic cells for monitoring the oxygen content under reduced gas pressure.

Two ROE 2001 automatic oxygen make-up system which control injection valves on the basis of signals received from oxygen sensors in the chambers. The dose could be regulated either on the basis of constant O₂ partial pressure, with a precision of 1 mb, or on the basis of a constant

DIAGRAM OF ATMOSPHERIC PARAMETER CONTROL SYSTEM

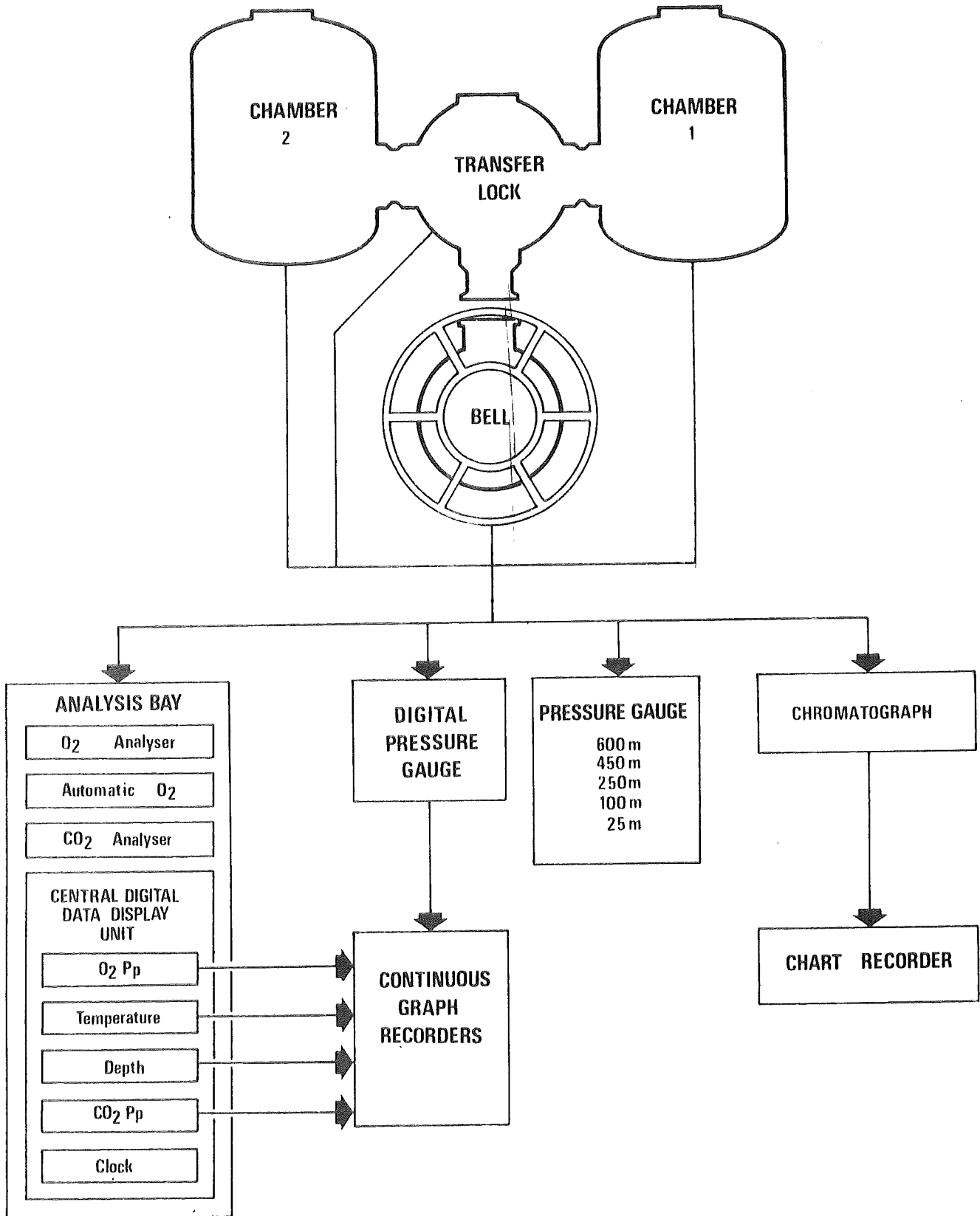

concentration, with a precision of 1/10th of 1 %.

A central digital data display unit comprising :

- a quartz chronometer showing the hour, minute and second;
- temperature reading in tenths of a degree Celsius measured by platinum thermometric probes (100 ohms at 0°C.) in the chambers ;
- oxygen partial pressure in mb measured by sensors in the chambers ;
- CO₂ partial pressure in tenths of mb, calculated continually and automatically by an electronic multiplier which processes the signals from the CO₂ analyzer and the pressure sensors.
- two indications of pressure in tenths and in hundredths of meters of sea water measured by STATHAM PG 872 sensors (precision 0.1 % m.f.s.).
- a DRUCK DP1 100 digital pressure gauge (accuracy 0.06 % m.f.s.) with two scales :
 - . 0-700 meters with indication in tenths of a meter of sea water
 - . 0-150 meters with indication in hundredths of a meter of sea water
- VIGIL pressure gauges with Bourdon type tubes (accuracy 0.25 % m. f. s.)

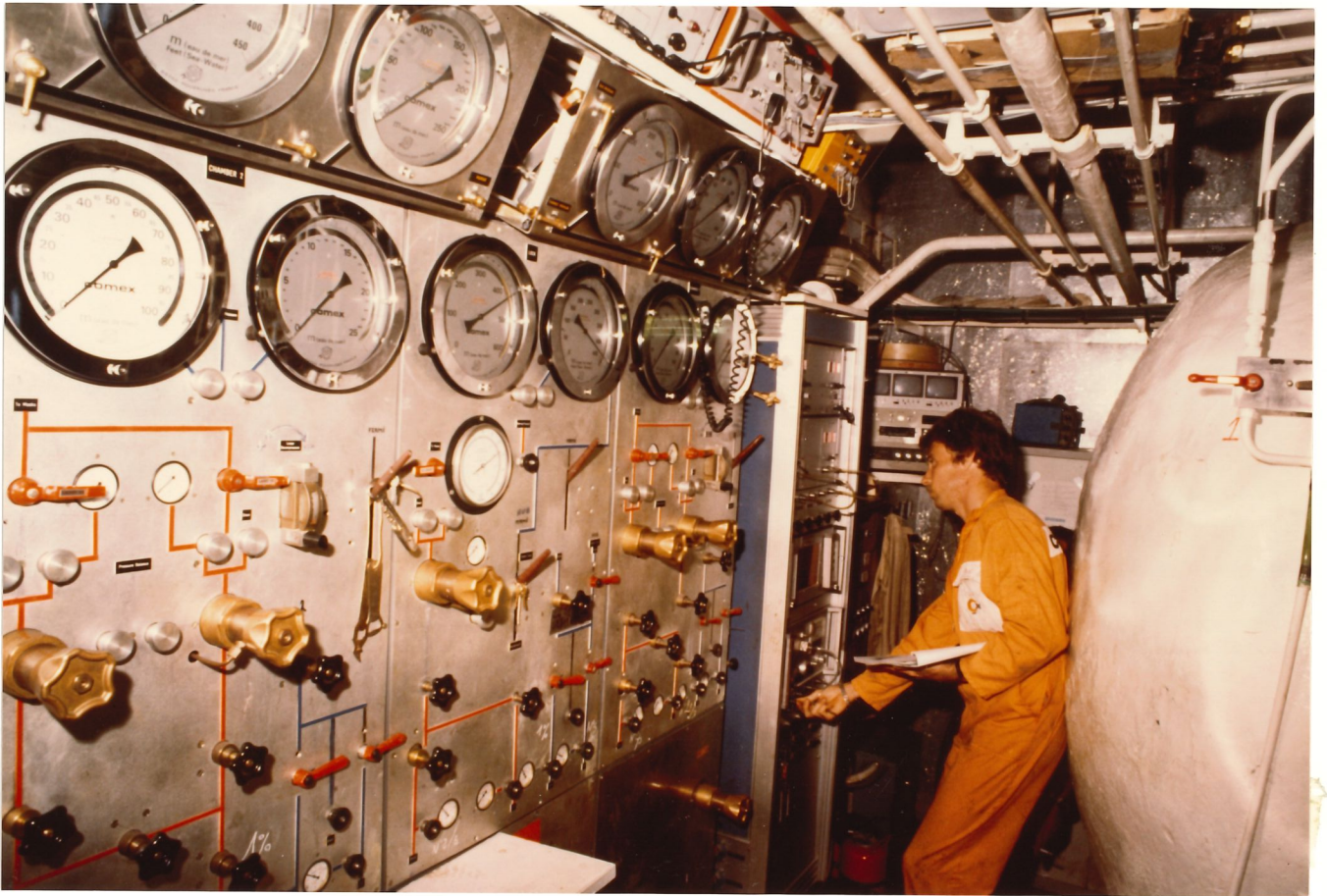

CENTRAL DATA UNIT AND CHAMBER
CONTROL STATION

For each chamber :

- a 0-600 m pressure gauge
- a 0-450 m pressure gauge
- a 0-250 m " "
- a 0-100 m " "
- a 0- 25 m " "

For the lock :

- a 0-600 m pressure gauge
- a 0-450 m " "

For the bell :

- two 0-600 m pressure gauges
- a Bourdon MTHP 0-600 m ultra-high precision pressure gauge accurate to 0.10 % m.f.s. working in parallel with the DP1 100 digital pressure gauge.
- two SEFRAM SERVOTRACE voltmeter recorders connected to the analog output of the data display center and digital pressure gauge.
- a SERVO RITER II TEXAS chart recorder
- hair hygrometers in the chambers which can be read through the viewports.

4) Communications

Due to the peculiar effects of helium the human voice is distorted in pressurized heliox atmosphere. This is what we call the "Donald Duck effect". For clear communication between

the divers and the "surface", therefore, there must be an unscrambling device. Two systems were used in parallel for "JANUS IV", a Helle 3340 unscrambler and a Sodelec/Marconi unscrambler.

B - DIVING EQUIPMENT

The "PETREL" was already equipped with its own diving system comprising the surface equipment described above, a diving bell and bell handling system, and a gas processing system. A number of modifications deemed necessary to use the diving system for "JANUS IV" were made prior to the operation.

1) Diving Bell

This is a spherical bell with an internal diameter of 2100 mm and including :

- An outer ring of 9 breathing gas cylinders for supplying the divers and bell (-460 m) in the event of umbilical failure between the bell and the surface.
- A cylinder of oxygen for maintaining oxygen partial pressure at the level specified by procedure.
- A gas control system for the bell.
- Gas panels for supplying divers and bellman individually.
- Its own gas regeneration system consisting of two KINERGETICS soda lime CO₂ scrubbers.
- Viewports providing visibility in all directions.
- The electrical installation necessary for supplying current to :
 - . the exterior spotlight circuit
 - . the interior lighting system
 - . the unscrambled communication circuitsbetween : bell and surface
 surface and divers
 bell and divers

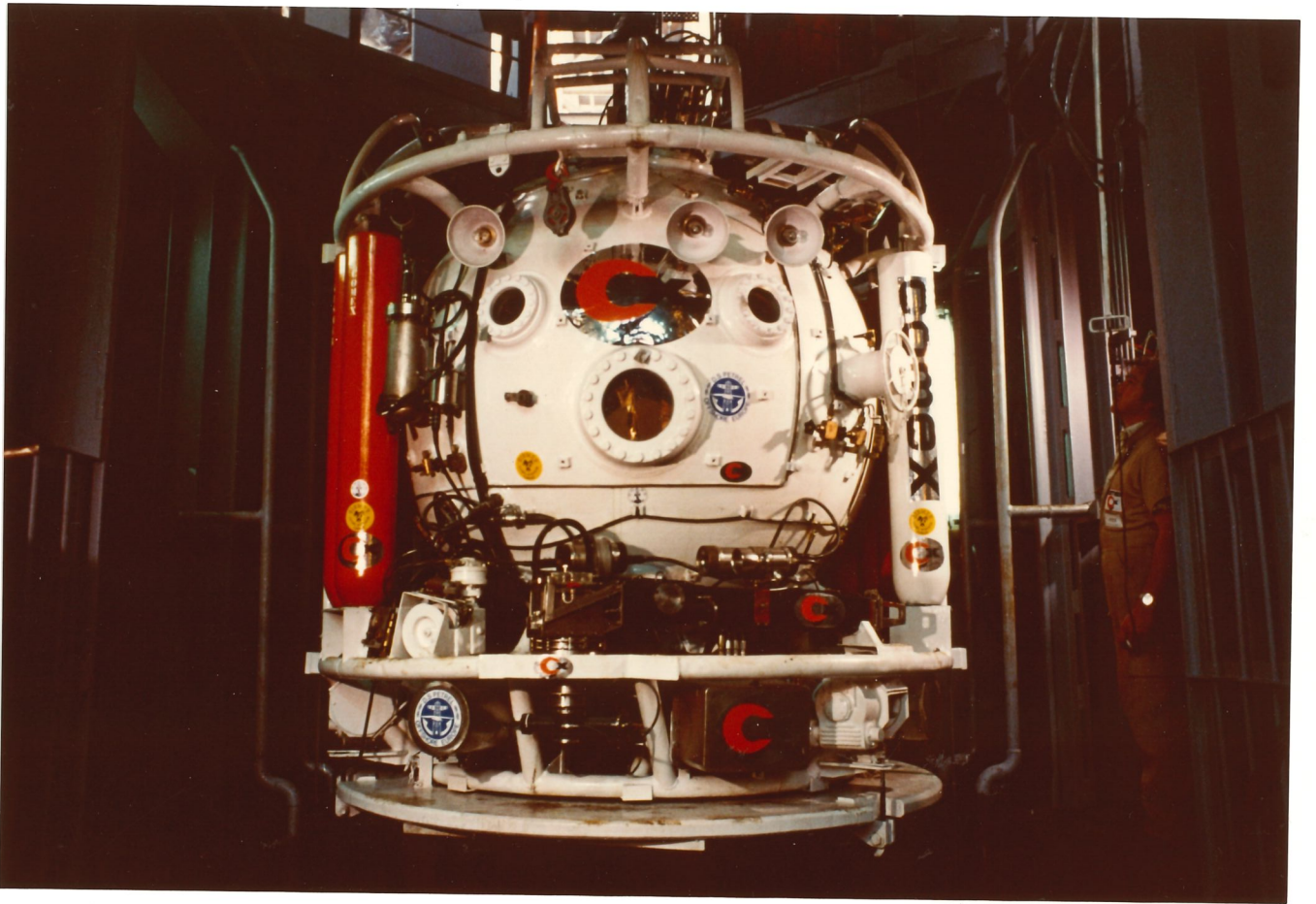

DIVING BELL

- A 700 mm clear diameter hatch in the bottom for diver exit and ingress to and from the worksite.
- Interior controls for opening and closing the exterior pressure-sealing hatch door.
- A lateral opening 600 mm clear diameter for clamping to the lock.
- The bell has a 30 mm layer of insulating material inside covered by a 0.8 mm sheet of stainless steel.
- Weight of the bell in air : 7 tons
Weight in water : 1.5 tons

2) Bell Handling System

This is a hydraulic system with a winch which has a normal brake, an emergency brake, a hydraulic power pack, and a pneumatic back-up system.

The electro-mechanical cable supplies the bell with electric power and includes the conductors necessary for communications and a television circuit, if used.

The winch controls are situated at the diving stage level in order to afford the winch operator maximum visibility.

The moon pool is equipped with a cursor system for lowering the bell safely, even when weather conditions are relatively bad.

This is composed of :

A yoke which moves on two rails mounted



BELL ON MOON POOL
WITH WINCHES

vertically the entire length of the moon pool. The yoke holds the bell down in order to counteract heave effect.

An electrically controlled overhead gantry for recovering the bell and transferring it to clamping electro-mechanical position, thus relieving the load on the cable.

3) Diving Gas Recovery System, or "Surface Loop".

"Surface Loop" is the term used to designate the closed circuit for reconditioning the breathing gas of the divers when they lock out of the bell. The regeneration apparatus is on the surface support.

The diagram on page 55 shows how the system works :

- The reconditioned gas from the surface is sent to the bell, where it passes through a charcoal and soda lime filter, then through the booster and via umbilical to the diver.
- A CORBLIN A4C60 diaphragm compressor is used as booster. In the event it should fail for any reason, a fail-safe device automatically switches the system back to the conventional open circuit.
- This system constitutes an alternative method of supplying a diver wearing a COMEX PRO full face mask with exhaust regulator, which does not, however, preclude the use of an open circuit system.

4) Diving Gas

A gas trailer was used for storage of the gas reserve

DIVING GAS RECOVERY SYSTEM (Surface Loop)

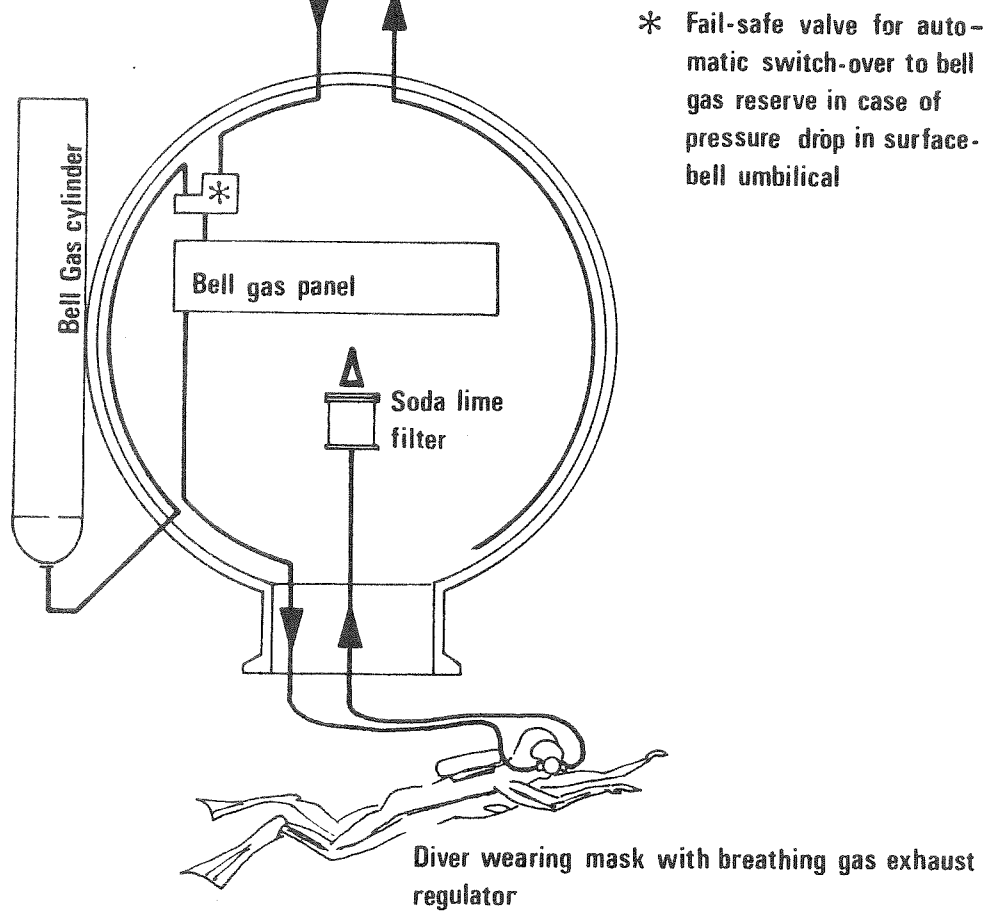
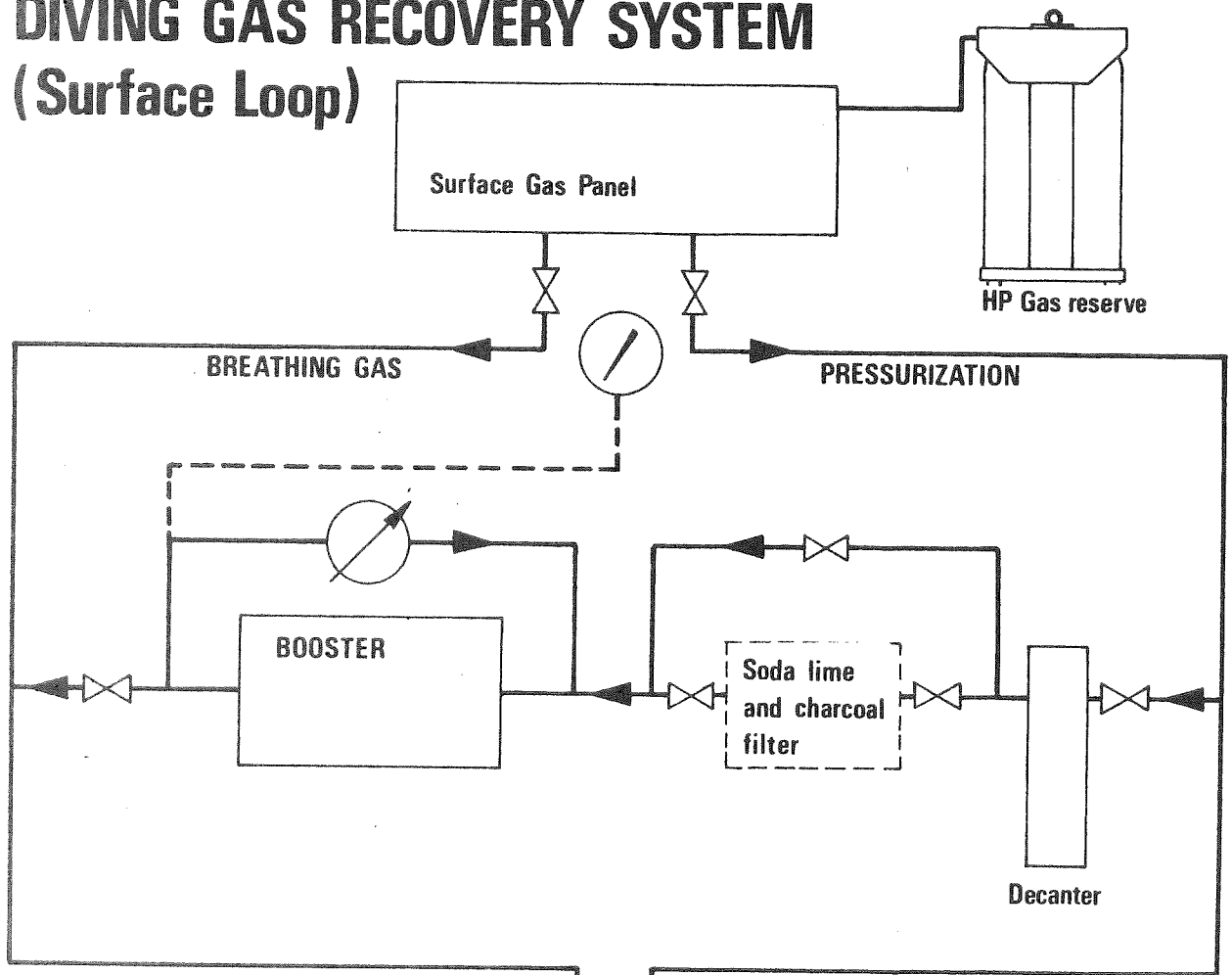

required for diving operations during "JANUS IV". The trailer had a 5000 cu. m. (175,000 cu.ft.) capacity and contained a mixture composed as follows :

helium	99 %
oxygen	1 % \pm 0.05 %
hydrogen	2 ppm
nitrogen	10 ppm
water	0.3 g/m ³ (0.0085 g/cu.ft.)
methane and equivalent	1 ppm
carbon monoxide	0.5 ppm

The helium used for this mixture had a minimum purity level of 99.995 %.

The 9 cylinders fixed to the bell were filled with the same mixture in case they should be needed in the event of surface-bell umbilical breakdown.

The gas mixtures used in the "JANUS IV" operation were supplied by GARDNER CRYOGENICS LTD.

5) Individual Diving Equipment

The individual diving gear used for the operation was identical to the equipment in current use on COMEX worksites : hot water diving suit, safety harness, COMEX PRO full face mask, bail-out bottle and gas heater.

The low pressure gas assembly on the standard COMEX PRO face mask was replaced by a combination pressure reducer-exhaust regulator.

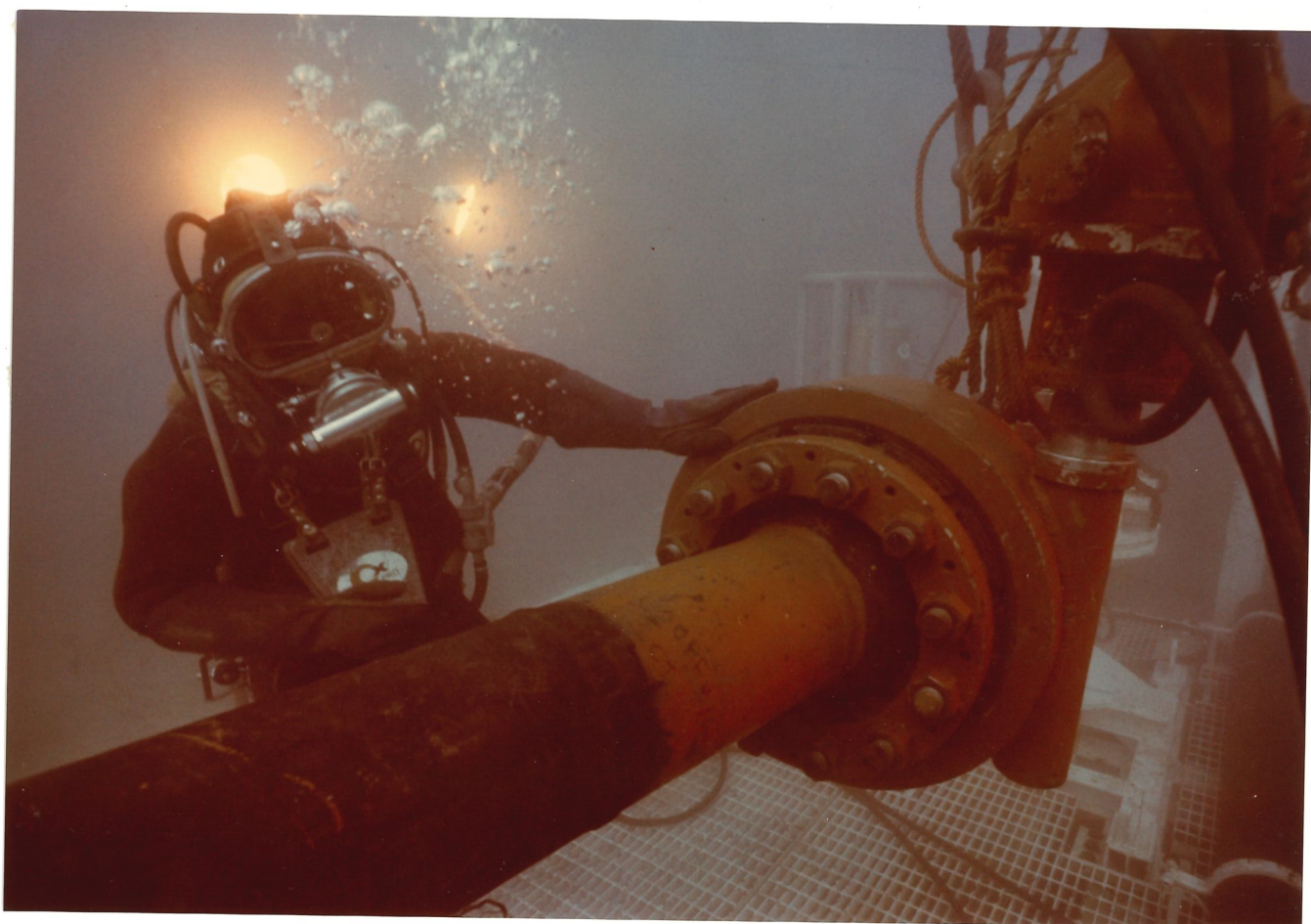

DIVER WEARING CX PRO FACE MASK WITH
EXHAUST REGULATOR IN FRONT OF COMPLETED
CONNECTOR CONNECTION

With this system the pressure reducer exhaust valve is replaced by a pipe connecting the pressure reducer outlet to the exhaust regulator inlet. The exhaust regulator is mounted on the pressure housing in order to have the two diaphragms (pressure reducer/exhaust regulator) at the same hydrostatic level.

If the exhaust regulator were higher than the pressure reducer it would be at a lower pressure and would leak constantly. If their relative positions were reversed it would be at a higher pressure and the diver would have to force his breathing to open it. A 1/2" gas return hose going to the diving bell is attached to the exhaust regulator outlet. At the bell end the hose is attached to a soda lime cartridge before which is mounted a non-return valve to prevent the diver being subjected to an over-pressure in case the bell should be inflated or should be higher than the bell.

A quarter-turn valve on this same hose shuts off the gas return to the bell if the exhaust regulator should fail. In this case the diver can open the purge valve on his mask manually to exhale through the mask.

The purpose of an exhaust valve, which is actually a demand valve reversed, is to exhaust gas at pressure $P + X$ toward pressure P without any danger to the diver's respiratory mechanism.

The COMEX PRO bail-out bottle has a capacity of 2.6 Nm^3 which gives the diver 2-3 minutes' autonomy at 460 meters' depth. The back pack was specially redesigned to contain the gas heater and streamlined to eliminate all rough edges and surfaces. Altogether it has a negative buoyancy in water of not more than 2 to 3 Kilograms (4 1/2 to 6 1/2 lbs).

C - WORK EQUIPMENT

One of the main purposes of Operation "JANUS IV" was to prove that divers could reach a depth of 460 meters and that they could perform work at that depth analagous to work that is now done regularly in the 200-meter range. It was therefore decided that to make Phase III a truly operational endeavor, the divers would make a mechanical connection between two 8" pipelines using a Comector.

This chapter describes the equipment and procedures used, in the following sections :

- 1) Possible formulae for installing a Comector.
- 2) Main features of the work table designed for "JANUS IV".
- 3) The Comector
- 4) Procedure for installing a Comector.
- 5) Procedure for setting the Comector in the event of hydraulic power failure.
- 6) Eguipping the work table prior to lowering it to 460 meters.
- 7) Precautions to be taken with hydraulic equipment while work table is being lowered.
- 8) Hydraulic check list prior to beginning work at 460 meters.
- 9) Procedure for using the pipe-cutter.

1) Possible formulae for setting the Comector.

Four different formulae, described below in order of increasing complexity, were originally proposed in connection with the work to be done on the sea bed and the equipment to be deployed. All four formulae employed a ball prewelded to one of the pipes, and all four of them simulated a Comector connection on a wellhead or riser.

FORMULA 1

- a) On the surface : the pipe is cut to the desired length and cleaned, the Comector is installed on the pipe and the axes of the parts to be joined are made to converge.
- b) On the bottom, the divers should :
- adjust the Comector longitudinally
 - capture the Comector ball in the housing
 - apply the tightening torque
 - connect hydraulic test hoses if necessary

Initial estimate of equipment required

1 work table
1 Comector
3 hydraulic come-alongs and hoses
1 impact wrench
1 hydraulic tool power pack
1 hydraulic test power pack and test equipment
1 TV camera mounted on work table
1 video tape recorder

FORMULA 2

- a) On the surface : the pipe is cut to the desired length and cleaned.

b) On the bottom, the axes of the two pipes do not converge; the Comector is on the work table. The divers should :

- set the Comector on the pipe
- make the pipe axes converge
- adjust the Comector longitudinally
- correct pipe alignment if necessary
- capture ball in housing
- apply tightening torque
- perform hydraulic test

Initial equipment estimate

- a more complex work table than for Formula 1
- the rest of the material used for Formula 1
- an alignment system

FORMULA 3

a) On the surface : the pipe is cleaned

b) On the bottom, the divers should :

- determine the length of pipe to be cut off
- cut pipe to desired length
- install Comector on the pipe
- bring pipes into convergent axes
- adjust Comector longitudinally
- correct pipe alignment if necessary
- capture ball in housing
- apply torque
- perform hydraulic tests

Initial equipment estimate

- same as for Formula 2 plus
- a guillotine system for determining pipe length
- a hydraulic pipe-cutter with buoyancy device.

FORMULA 4

At the bottom, the divers should :

- determine the length of pipe to be cut
- determine the length of pipe to be cleaned
- clean pipe over desired length
- cut pipe to desired length
- install Comector on pipe
- apply torque
- perform hydraulic tests

Initial equipment estimate

- same as for Formula 3, plus
- concrete stripping equipment and buoyancy unit for same.

As Formula number 4, while more complex, did not contribute any new solution to the problem of making a mechanical connection, it was decided to use Formula 3 for "JANUS IV" Phase III.

2) Main features of the work table designed for "JANUS IV"

The work table for "JANUS IV" was designed to meet the following requirements :

- To facilitate lowering the dimensions of the table had to be smaller than the PETREL's moon pool but large enough to be able to simulate a pipeline connection with a Comector, including equipment for shifting the pipe.
- The work table will be attached to the drill pipe of the PETREL and should be heavy enough to permit effective compensation of the heave and to limit oscillations that might create currents too strong for the divers.

- In order to prevent oscillations and to be able to use the heave compensator, a 16-ton anchor hung from a 20-meter sling under the table will be deposited on the sea bed.
- As the divers will be using air bags there should be a 5-meter clearance above the work level. This meant the table must be slung onto a cross-shaped spreader beam rather than using a conventional pyramidal slinging system.
- To facilitate transport and handling the table frame was divided into two sections, each of them half the total length. The uprights to be fitted onto the table for mounting tools, lamps, etc., were also made in sections, for the same reason.

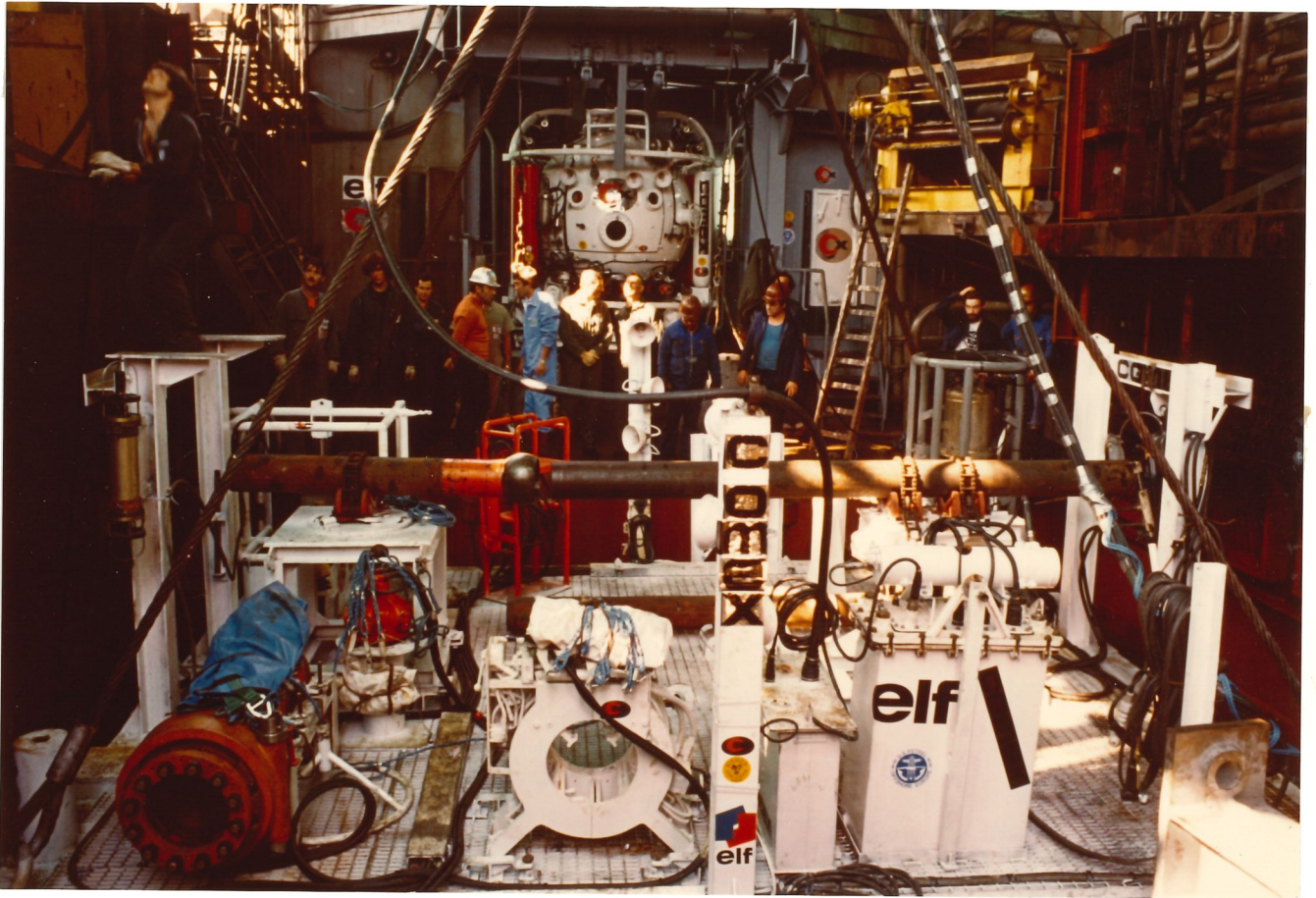

WORK TABLE

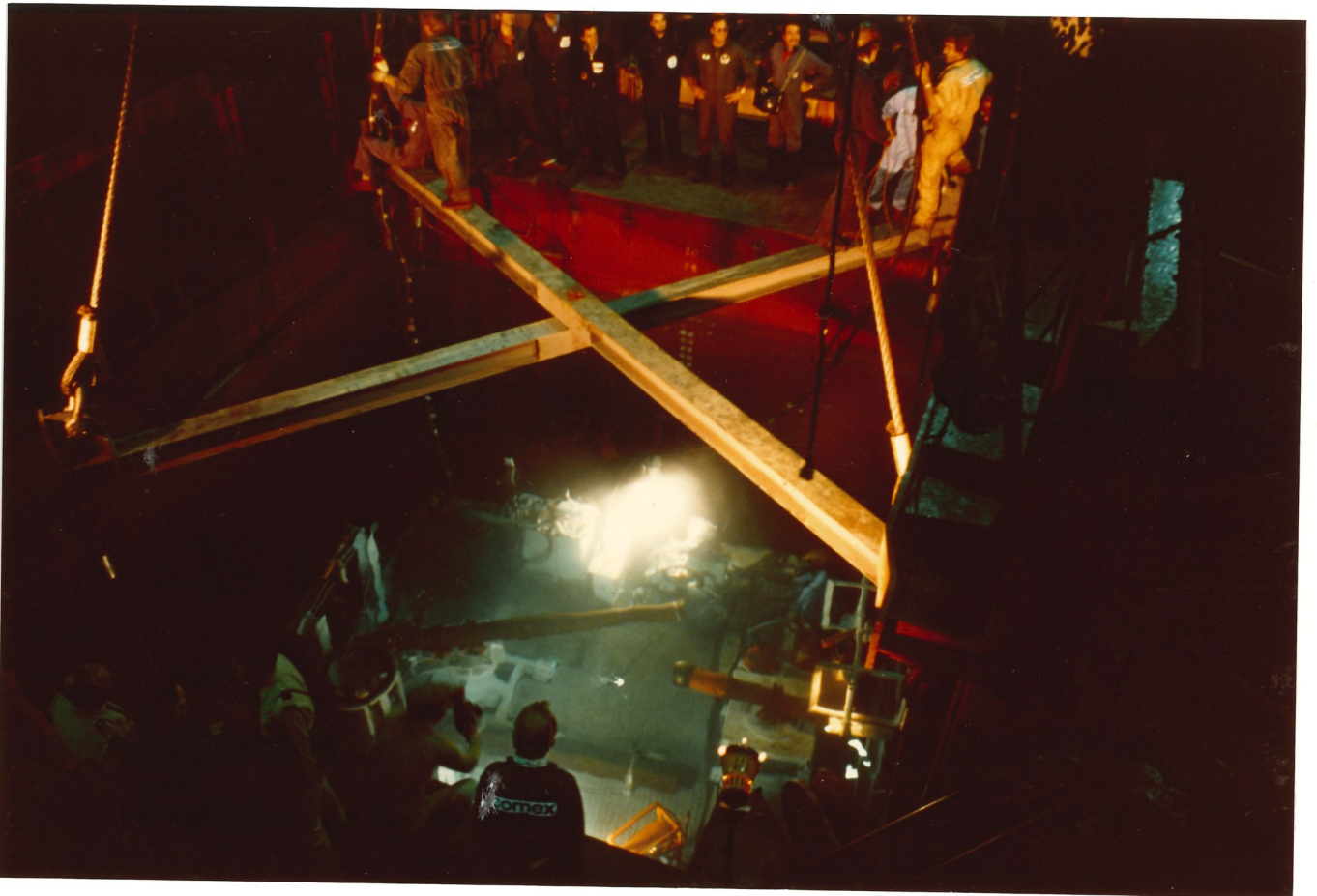

LOWERING WORK TABLE
THROUGH DRILLING POOL
(VIEW FROM UPPER CROSS-BAR)

The characteristics of the table are as follows :

- . length 6 meters 20 feet
- . width 5.3 meters 17'5"
- . weight stripped about 10 tons
- . estimated total weight including anchor, slings, chains and cross-bar : about 35 to 40 tons

Each of the slings holding the table had a breaking point of about 130 tons and was equipped with 35 ton shackles on the ends with a breaking point of over 160 tons, in conformity with the safety standards in force for hoisting apparatus.

The slings supporting the anchor weight each had a breaking point of about 45 tons and 25-ton end shackles with a break load of over 45 tons. (p 67)

The table was equipped with the following :

- a revolving stage for simulating shifting of the pipe
- a Porta-Tool pipe cutter (p 68)
- a Comector
- a 3 meter length of 8" pipe (th. $\frac{1}{2}$ ") in which the Comector body assembly was to be installed.
- a 1.5 meter length of pipe to which the ball part of the Comector was to be connected ; this part was mounted on a swivel frame in a position preselected as a function of the angle of misalignment desired.
- an extra 3-meter length of pipe
- an underwater hydraulic power pack (p 71)
- a Staffa torque motor for tightening the Comector
- 2 hydraulic Come-alongs on the H-frames behind the pipes

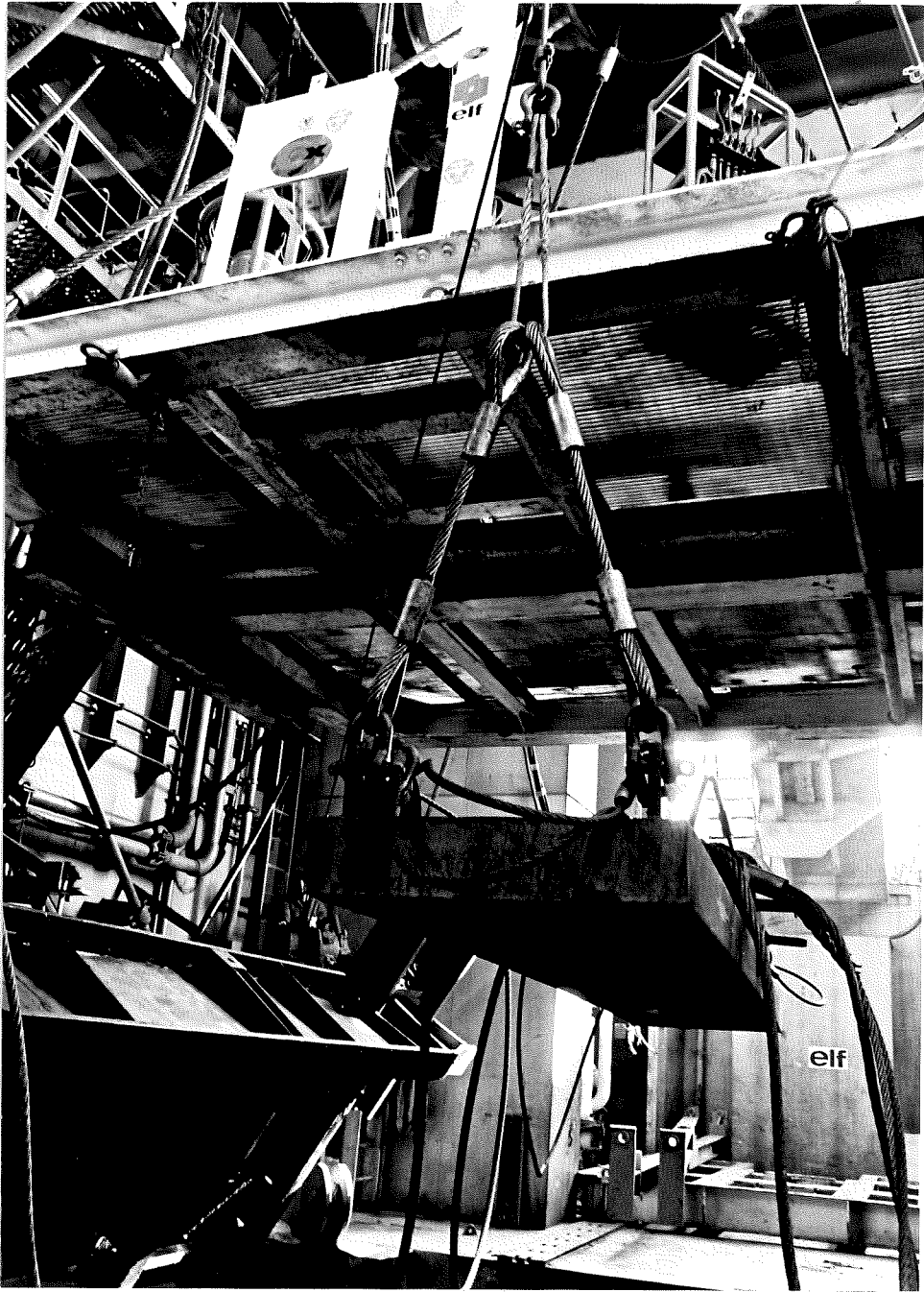

ANCHOR WEIGHT UNDER WORK TABLE PRIOR TO LOWERING

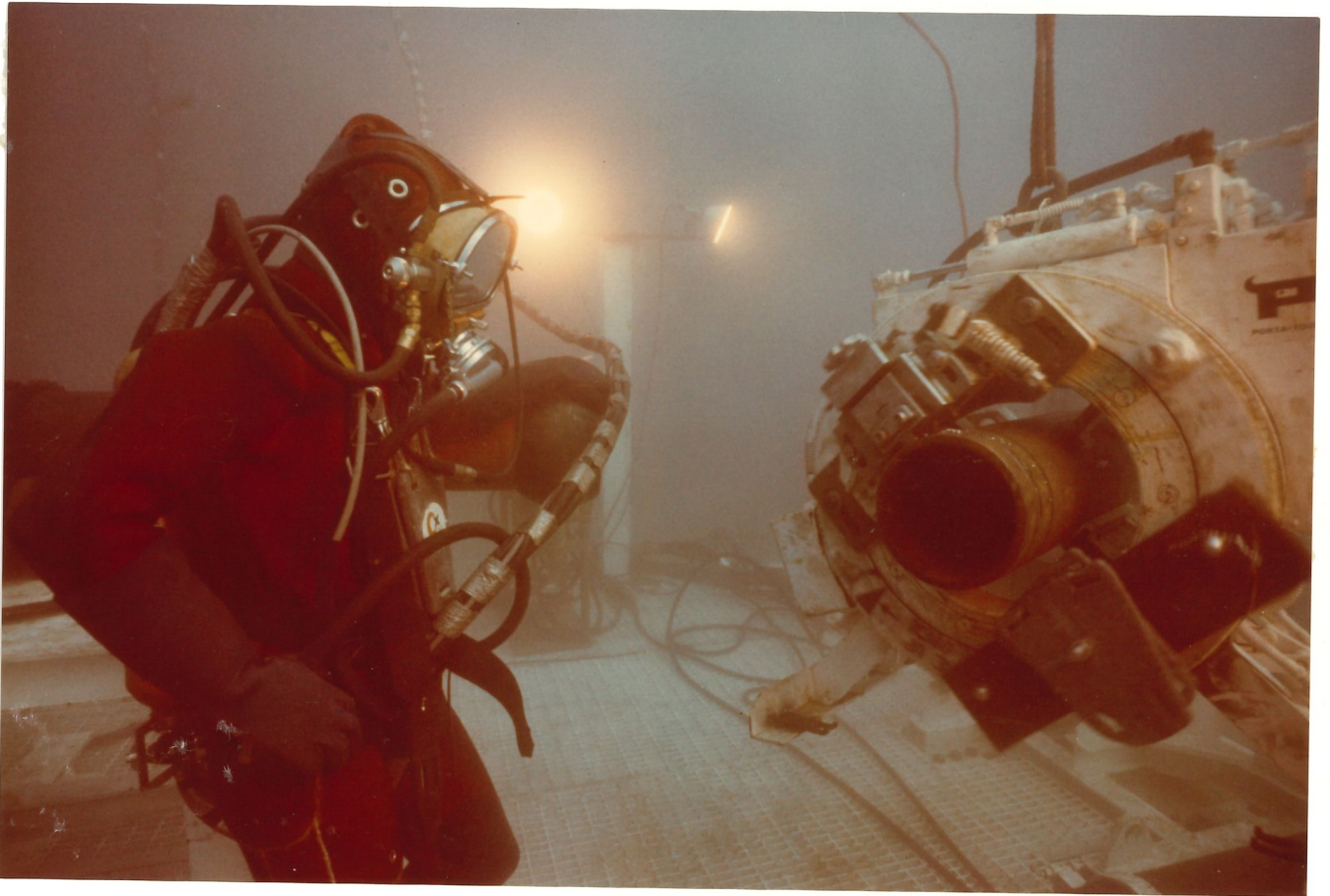

PIPE-CUTTER INSTALLED ON PIPE BY DIVER

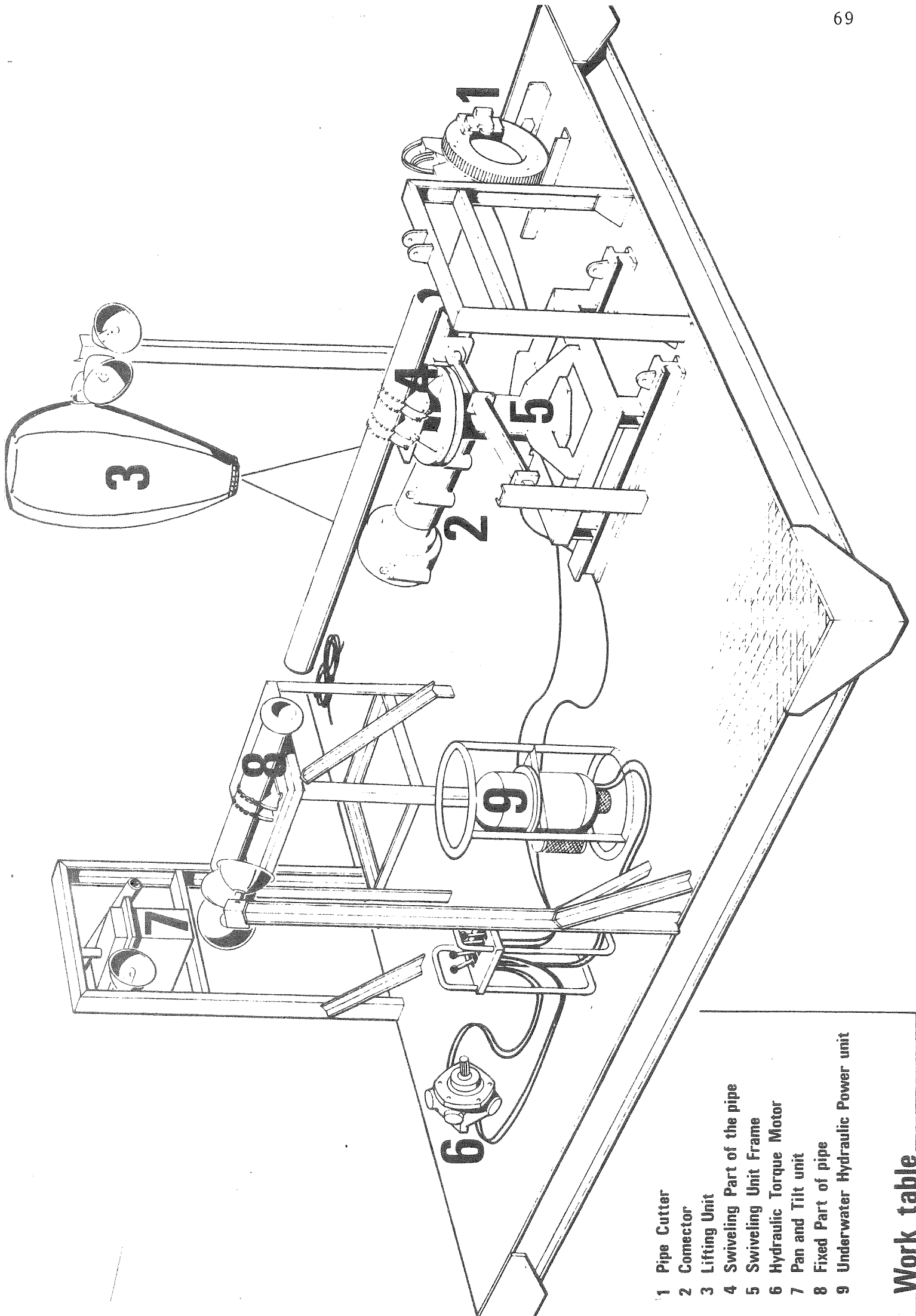

- 1 Pipe Cutter
- 2 Connector
- 3 Lifting Unit
- 4 Swiveling Part of the pipe
- 5 Swiveling Unit Frame
- 6 Hydraulic Torque Motor
- 7 Pan and Tilt unit
- 8 Fixed Part of pipe
- 9 Underwater Hydraulic Power unit

- a hydraulic ram for turning the revolving stage
- 2 posts each holding three 500-watt spotlights. They could also be used as fixing posts for the Come-alongs in case of hydraulic power failure ; the Come-alongs could then be used mechanically for turning the stage
- a control console for all the hydraulic tools (p 72)
- a frame on which a pan and tilt television unit can be mounted.
- various and sundry tools such as air bags, inflation hoses, etc.

The table will be covered with grating (p 73).



DIVER MOVING TORQUE MOTOR
FOR COMECTOR WITH THE AID
OF AN AIR BAG

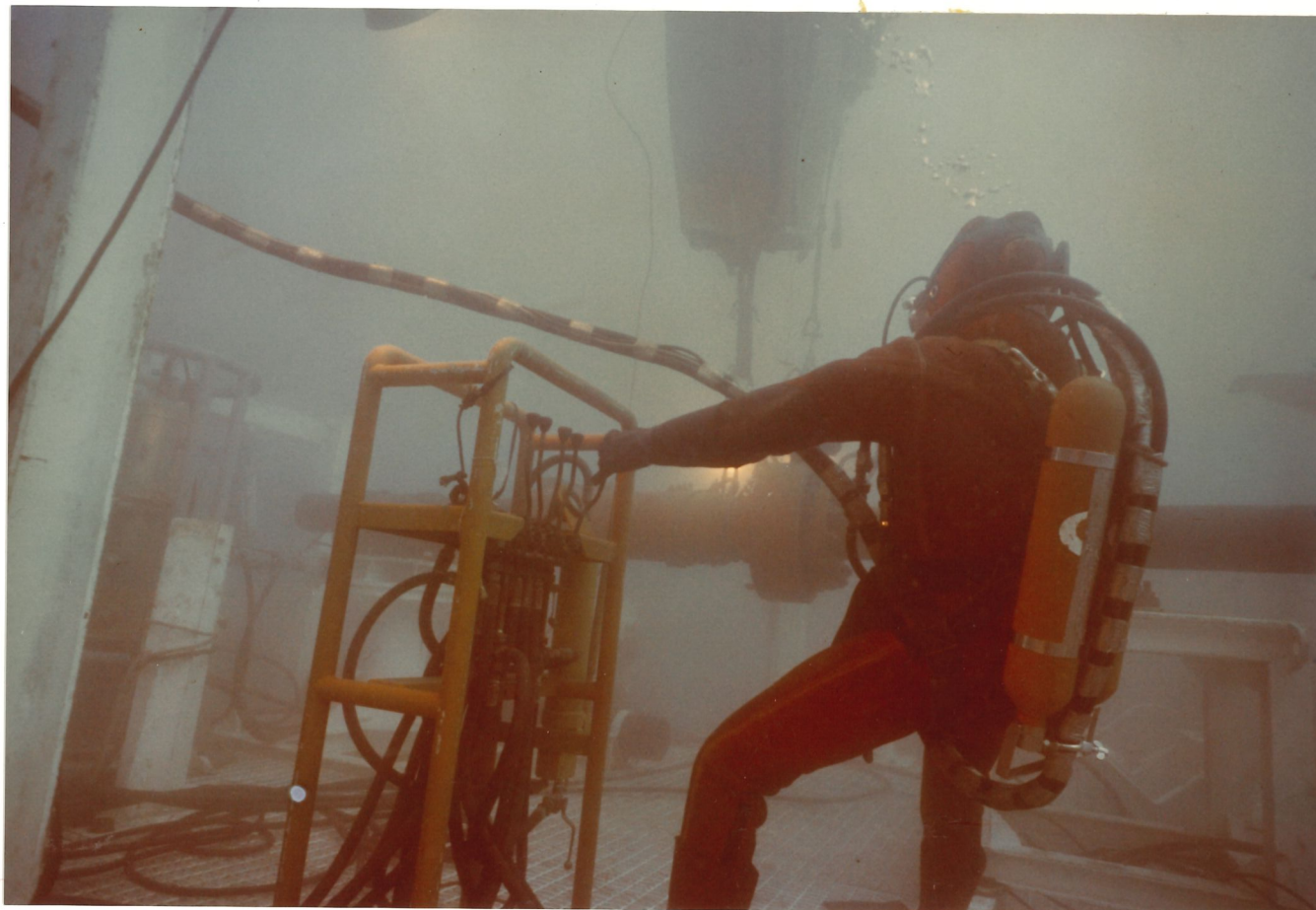

HYDRAULIC CONTROL PANEL

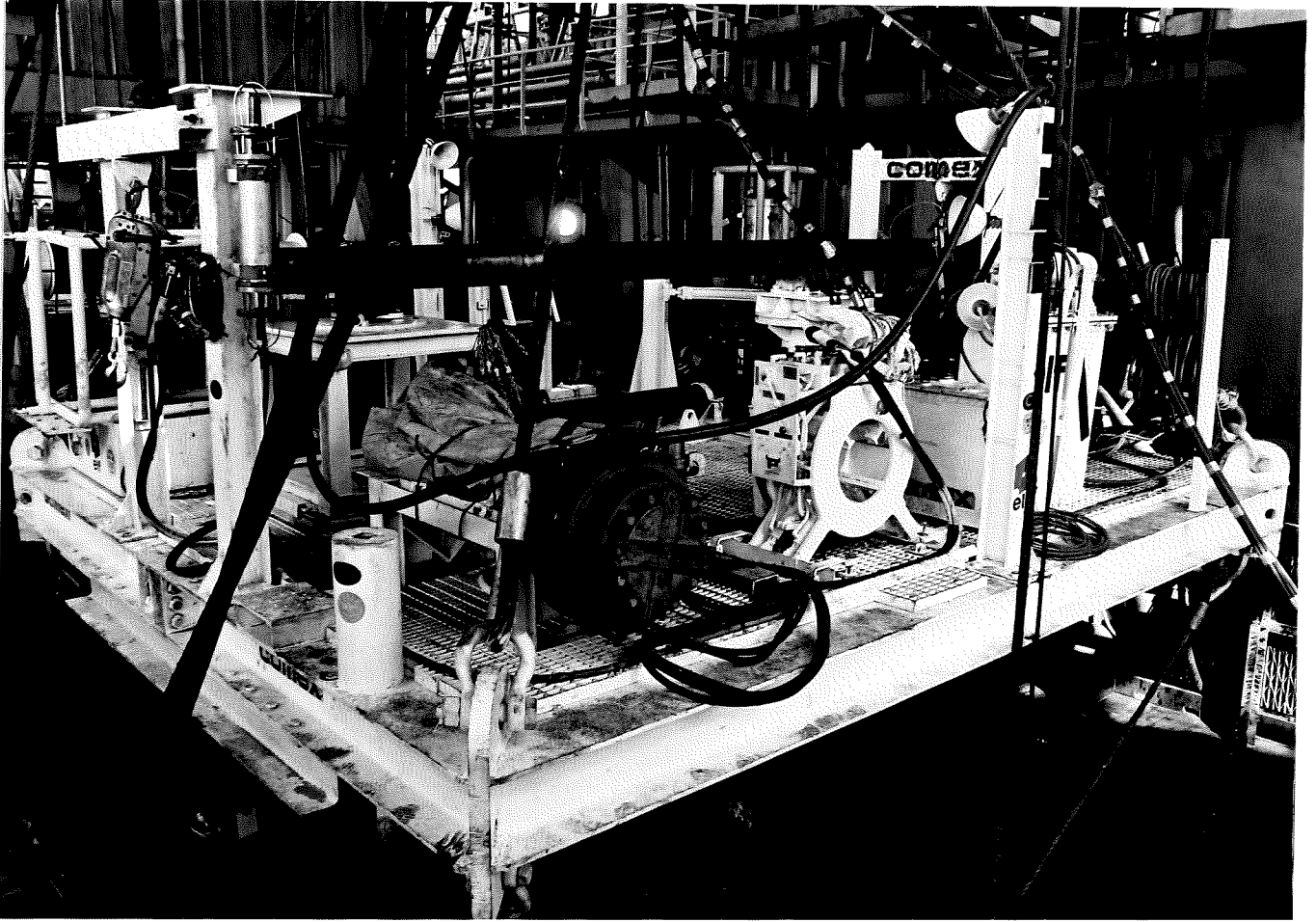

WORK TABLE

3) The Comector

Deepwater pipeline connection is one of the most difficult problems encountered in offshore oil operations.

Now, with the development of the Comex Comector, a ready solution has been found.

From years of experience gained in connecting underwater flowlines throughout the world, Comex engineers drew up the exacting specifications from which the Comex Research Division successfully developed the Comector.

The Comector has many advantages over conventional systems for coupling pipelines. It achieves a tight seal entirely by mechanical compression. Once set it remains perfectly rigid, even if pressure in the pipelines is completely released. It can be re-set easily or, if required, completely uncoupled without difficulty. The design also provides up to 10° angle adjustment to facilitate the connection of misaligned pipes.

Applications for which the Comector is primarily intended include riser repair and installation and mid-line connection and repair.

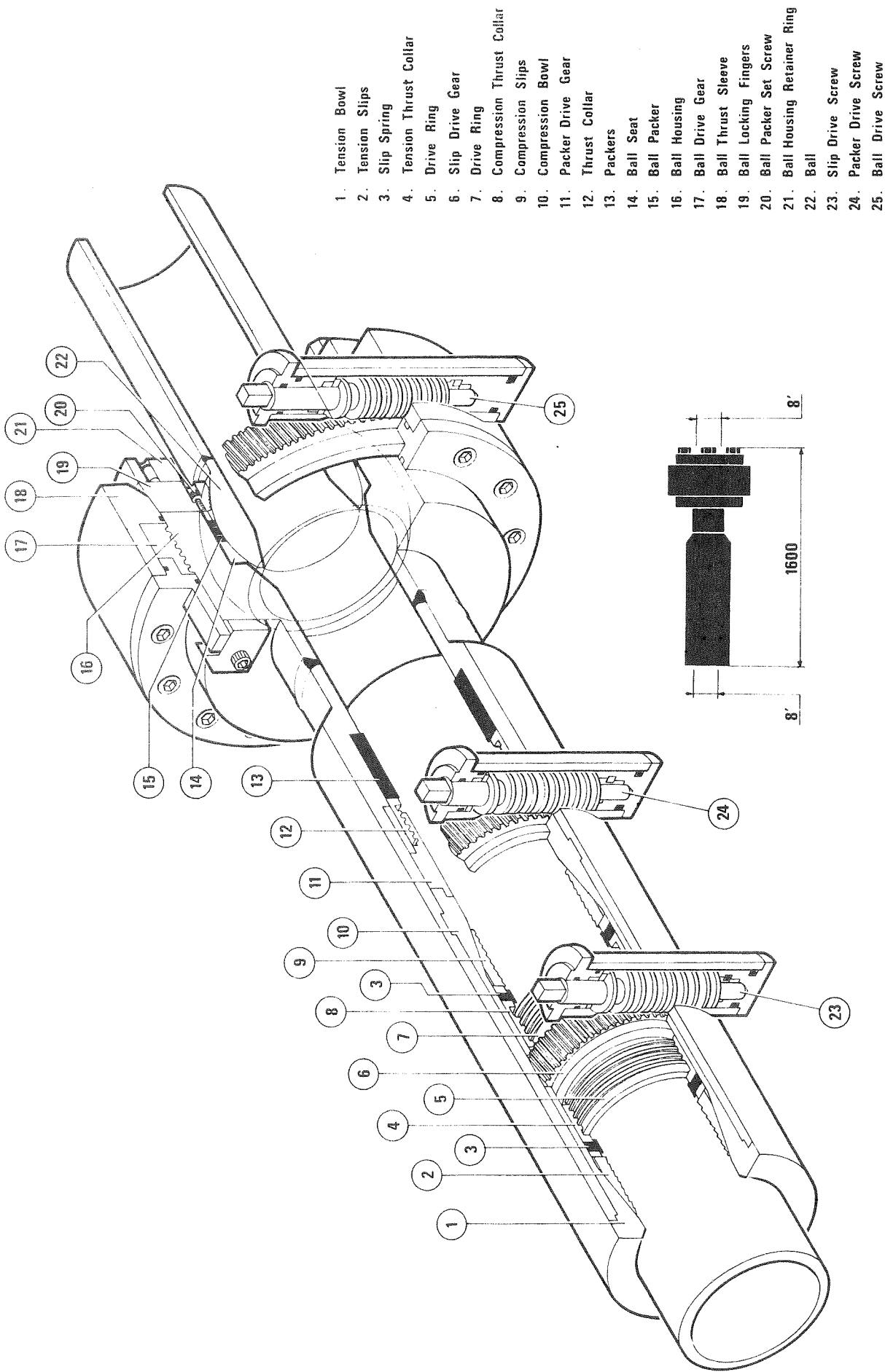

- 1. Tension Bowl
- 2. Tension Slips
- 3. Slip Spring
- 4. Tension Thrust Collar
- 5. Drive Ring
- 6. Slip Drive Gear
- 7. Drive Ring
- 8. Compression Thrust Collar
- 9. Compression Slips
- 10. Compression Bowl
- 11. Packer Drive Gear
- 12. Thrust Collar
- 13. Packers
- 14. Ball Seat
- 15. Ball Packer
- 16. Ball Housing
- 17. Ball Drive Gear
- 18. Ball Thrust Sleeve
- 19. Ball Locking Fingers
- 20. Ball Packer Set Screw
- 21. Ball Housing Retainer Ring
- 22. Ball
- 23. Slip Drive Screw
- 24. Packer Drive Screw
- 25. Ball Drive Screw

comector

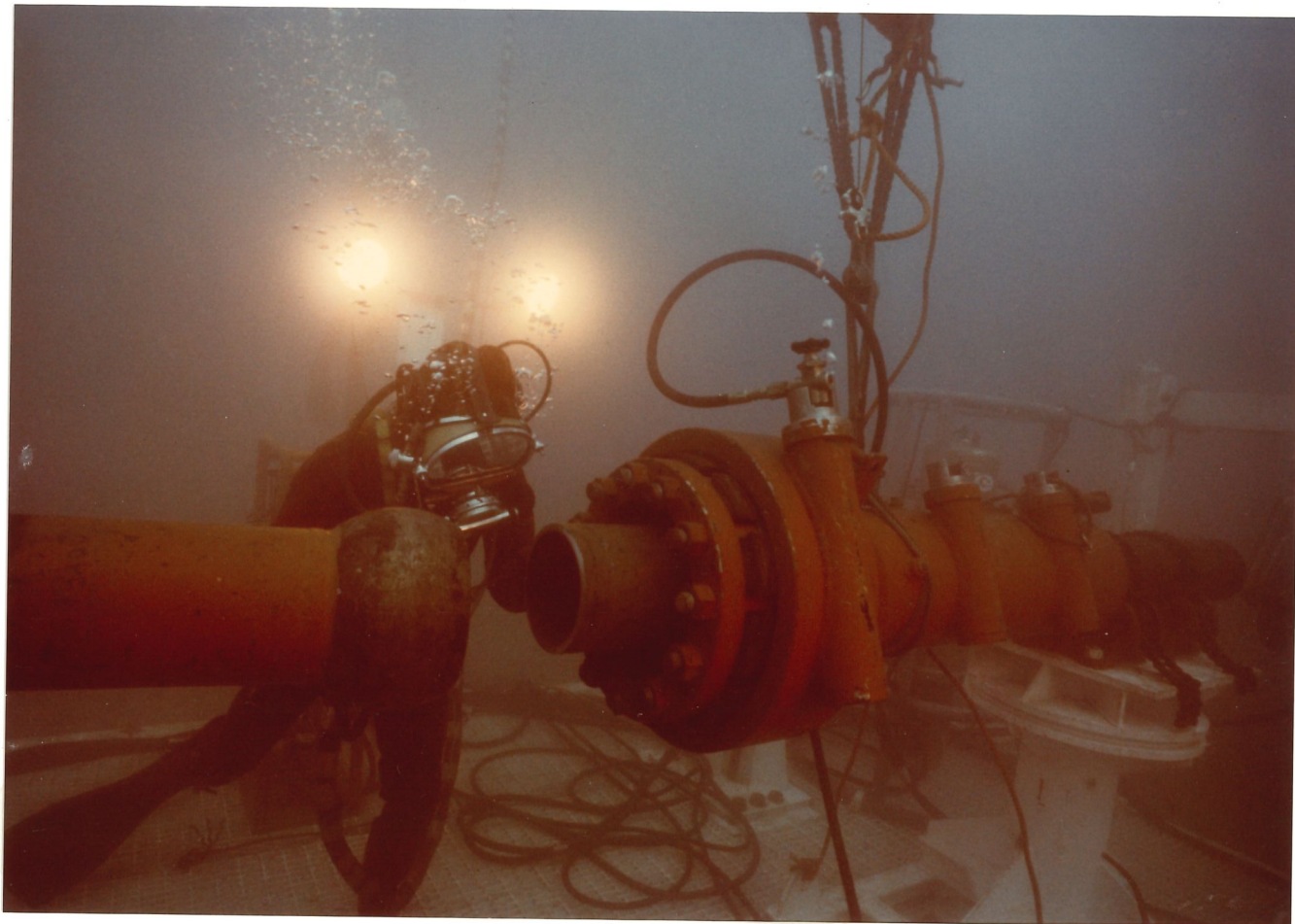

THE COMECTOR BEFORE BEING STABBED TO THE
BALL PART.

4) Procedure for installing a "COMECTOR"

- 1° Activate the hydraulic ram to bring the mobile part of the pipe as close as possible to the ball part.
- 2° Make a saw-mark on the mobile pipe at the place where it is to be cut.
- 3° Move the mobile part away from the ball part with the ram, making an angle of about 30°, or about 3/4 of the ram stroke.
- 4° Put the small air bag on the pipe cutter and inflate it with the air hose provided on the work table. The pipe cutter will already have been fastened down with a strap and shackle to prevent it rising.
- 5° Put the pipe cutter on the pipe.
- 6° Start the pipe cutter.
- 7° Remove pipe cutter from pipe and refasten in its place.
- 8° Take air bag off pipe cutter and put it on the Staffa torque motor without inflating.
- 9° Connect air hose to buoyancy unit of Comector.
- 10° Open compressed air valve slightly until it rises.
- 11° Adjust buoyancy as necessary.
- 12° Put Comector onto pipe taking care not to block the tension slips.

- 13° Align mobile part and ball part of pipe using hydraulic ram.
- 14° Enclose ball in ball housing. It is very important not to block the tension slips during this part of the operation.
- 15° Remove buoyancy apparatus from Comector.
- 16° Inflate Staffa motor air bag. The motor will also have been fastened down.
- 17° Put Staffa on square part of ball drive screw.
- 18° Be sure to deflate Staffa motor air bag to an effective weight of about 15 kg.
- 19° Using the valve on the hydraulic console operate the Staffa motor until the correct pressure is reached on the pressure gauge.
- 20° Follow steps 17, 18 and 19 for the packer drive screw in the middle of the Comector.
- 21° Do the same for the slip drive screw at the other end. Be sure to proceed in this order.
- 22° Anchor the Staffa motor in place once more.
- 23° Before surfacing from the final dive check to see that :
 - the inflating hose is coiled on the work table.
 - all tools and equipment used for the job are properly anchored in place.

5) Procedure for setting Comector in case of hydraulic breakdown

- a) The pipe cutter will not function and pipecutting has not yet been started

The pipe will not be cut, the right distance between the mobile pipe and the fixed pipe is obtained in the following way :

- Loosen the fixation system of the ball set pipe.
- use the tugger that is behind the fixed pipe on the H-frame. Fasten the tugger cable to the flange just behind the ball. Activate the tugger (hydraulically if it is still possible, otherwise manually) in such a way as to pull the ball back the required distance. If the fixed pipe was pulled back too far by mistake, use the tugger behind the rotating part to bring it forward.

- b) The pipe cutter no longer functions and cutting has begun

Take the cutter off the pipe, loosen the fixation system of the mobile pipe and remove the chain. Put a 300 l. air bag on the damaged pipe to make it buoyant and replace it with the extra pipe length placed near the revolving stage. This will require two divers.

- c) If the hydraulic ram for turning the mobile part of the Comector does not work.

Use the hand pump to get it working. If this is too difficult, another diver can unhook one of the tuggers from the frame and attach one end to the spotlight

stand (a pack-eye will be provided for this) with the cable fastened on the pipe. One diver works the ram while the other works the tugger.

6) Equipping the work table prior to lowering it

- 1° The mobile pipe is installed with a slight overlength ; it should extend about 20-50 cm (8-20") beyond the place where the ball enters. Be sure the gallows frame does not hinder the pipe's rotation. The two viraxe chains should be taut.
- 2° Install the shifting ram.
- 3° Fasten pipe-cutter to its base.
- 4° Fix the Comector in its support.
- 5° Install the hydraulic power pack on the flexible mountings.
- 6° Fasten the Staffa motor to its base.
- 7° Weld console frame in position on the grating and fasten with a line.
- 8° Fasten the mobile pipe down with a line which can be cut easily by the divers, to prevent it from turning during the descent.
- 9° Install the two Come-alongs (tuggers) on the H-frame and fasten with a line.
- 10° Make the hydraulic connections.
- 11° Install the extra piece of pipe on its stand.
- 12° Mount the spotlights on the uprights.

- 13° Make the electric connections for the power pack and the spotlights.
- 14° Install, connect and check the pan & tilt unit and the fixed television camera.
- 15° Test all hydraulic functions and spotlights.

7) Precautions to be taken with hydraulic equipment while work table is being lowered

In order to ensure that all hydraulic circuits will be pressure-equalized, it is essential that the following precautions be observed during lowering and until the table is in position on the bottom :

Hydraulic power pack

The valve at the top of the power pack is closed and plugged.
The power pack is turned on.

Control console

N.B : The normal position for the lever, when it is not locked, is neutral.

Before lowering, put the levers in the following positions :

Staffa motor lever	:	torque
Come-along 1	:	neutral
Come-along 2	:	neutral
Shift lever	:	ram rod retracted
Pipe-cutter lever	:	neutral

Control valves on pipe-cutter

Off - On - Off	position	On
Clamp-Unclamp	"	Unclamp
Latch-Unlatch	"	Latch
Open-Closed	"	Closed

The handles of the last two valves should be removed, as they will remain in this position during the entire

handling operation. Store in the tool chest.

Hand pump valves

There are a three-way valve and two quick-lock valves under the hand pump on the console.

The three-way valve is located just under the pump (small orange valve).

The two quick-lock valves are located on the hoses (red handles).

Put the three-way valve in NEUTRAL (middle position).
Put the quick-lock valves in CLOSED position.

Shifting ram

The quick-lock valve on the ram should be OPEN during lowering.

When the table is on the bottom, the power pack is turned off from the surface.

8) Hydraulic check list prior to beginning work at 460 m

Before starting up the hydraulic power pack the divers should put the valves and controls in the following positions :

Control console

All levers in neutral.

Pipe-cutter

Off-On-Off, in OFF position. The rest of the directional valves and controls should remain as they were during descent.

Hand pump

Leave the three valves as they were during the descent.

Shifting ram

By-pass valve : CLOSED

9) Procedure for using pipe-cutter

a) Operation

The pipe-cutter is tested and adjusted at the surface before the work table is lowered.

It is not necessary in this particular case to open the pipe-cutter in order to position it on the pipe. This is why the Open-Close and Latch-Unlatch valve handles were removed, so as to avoid making a mistake.

Proceed as follows :

- Make sure the CLAMP-UNCLAMP valve is on UNCLAMP, the OFF-ON-OFF valve is OFF, and that the adjustable clamp shoes are retracted.
- Make sure the jack screw compresses the cutter frame spring.
- Put a 250-liter air bag on the pipe-cutter and slip the cutter over the end of the pipe.
- Turn the Clamp-Unclamp valve to CLAMP, leaving the OFF-ON-OFF at OFF.
- Return to the control console and ask the surface to turn on the power pack. Hold the pipe-cutter lever in ON position for about 30 seconds, then put it in neutral.
- Make sure the two fixed upper clamp shoes and the two hydraulically operated adjustable clamp shoes grip the pipe tightly.

- Loosen the jack screw in the spring bracket.
- Adjust the cutter head so that the cutting blade is a few millimeters from the pipe but not touching it (in case there should be an out-of-roundness).
- Turn the OFF-ON-OFF valve to ON, leaving the CLAMP-UNCLAMP valve on CLAMP.
- Return to the control console and put the pipe-cutter lever in ON position, blocking it with the key.

b) What to do if the cutting blade gets stuck.

Sometimes the cuttings from the pipe collect in front of the blade and jam it during cutting.

Usually it is not possible to continue cutting with the same blade. In order to avoid breaking the blade, proceed as follows :

- As soon as the blade jams, remove the key and put the controls in neutral.
- Turn the OFF-ON-OFF valve on the pipe-cutter to off and the Clamp-Unclamp valve to UNCLAMP.
- Go back to the console and hold the pipe-cutter lever in ON position for about thirty seconds to relieve tension in the tool.
- Release the lever, put the Clamp-Unclamp on CLAMP, hold the lever at ON position once more, and then put it back in neutral. This should retighten the clamp shoes on the

pipe so that the pipe-cutter will not move.

- Now the register roll can be disengaged and the cutting head raised without breaking it. Try to remove the cuttings that jammed the tool. If this is not possible, raise the cutting head above the mound of cuttings and clean out the cutting groove.
- Re-engage the register roll and resume cutting as before.

NOTE : If the pipe-cutter has moved, start the cut in another place with a new blade.

The mechanical connection was not the only work task envisaged for Operation "JANUS IV". To make the operation as complete and homogeneous as possible, underwater cutting with BROCO ULTRA-THERMIC RODS and welding tasks were also performed.

For this the following equipment was deployed :

- On the work table

- . A pressure-equalized underwater welding set was fixed to the work table. The advantage of an underwater set is that it requires considerably less cabling.
- . An underwater electric container was installed for the welding set, complete with controls for regulating the welding current and the set itself.
- . A 1000/440 volt stepdown transformer permitted selection of welding current.

- A 700-meter (2300 feet) umbilical with a breaking point of 10 tons for supplying 1000 volt 60 Hz current to the welding set on the work table.

- On the surface

- . An umbilical winch
- . A 440/1000 volt stepup transformer in a container and electrical panels for supplying the welding set and the winch hydraulic power pack.

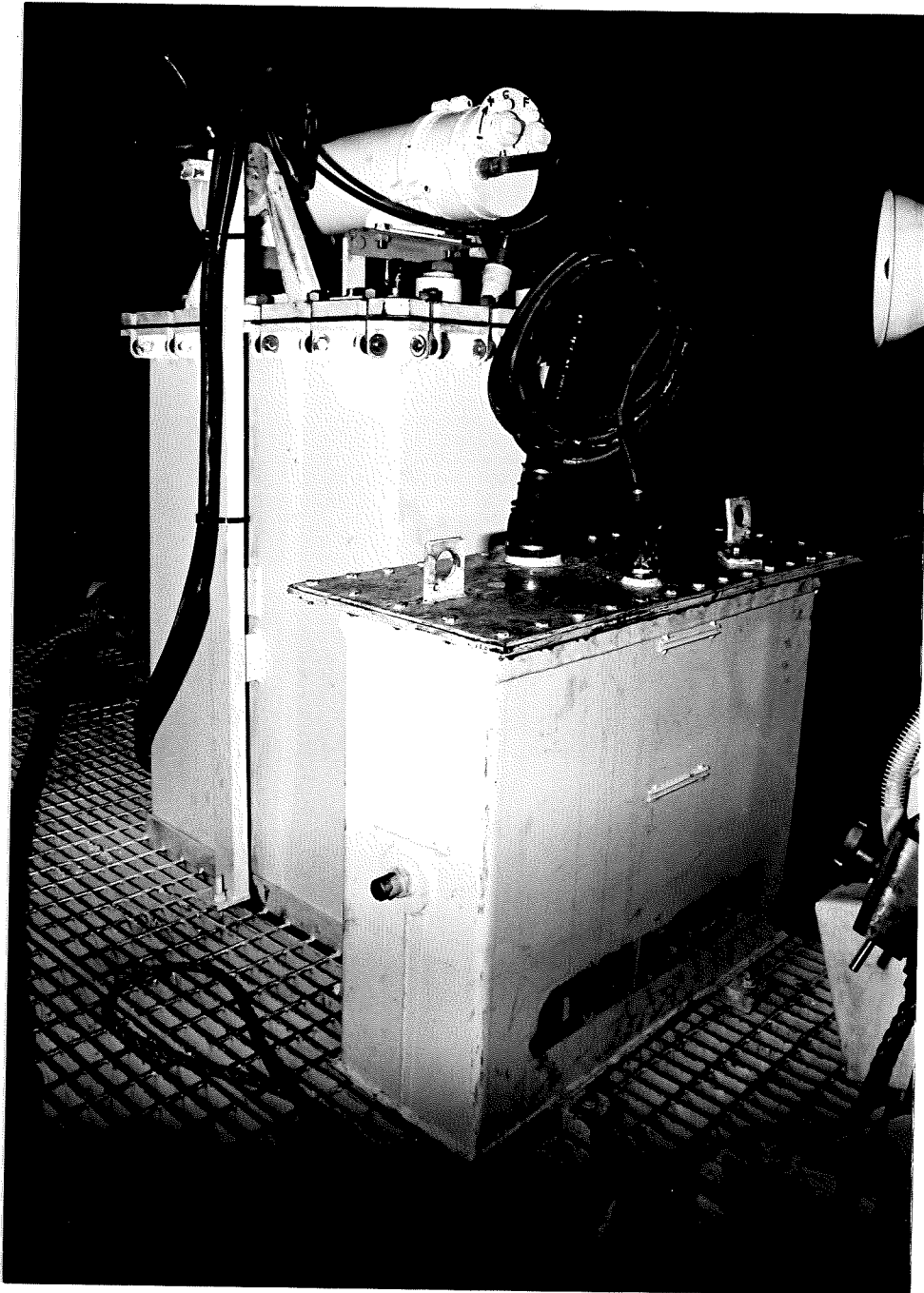

- UNDERWATER WELDING SET
- ELECTRIC CONTAINER AND TRANSFORMER

DIAGRAM OF SYSTEM USED FOR UNDERWATER WELDING

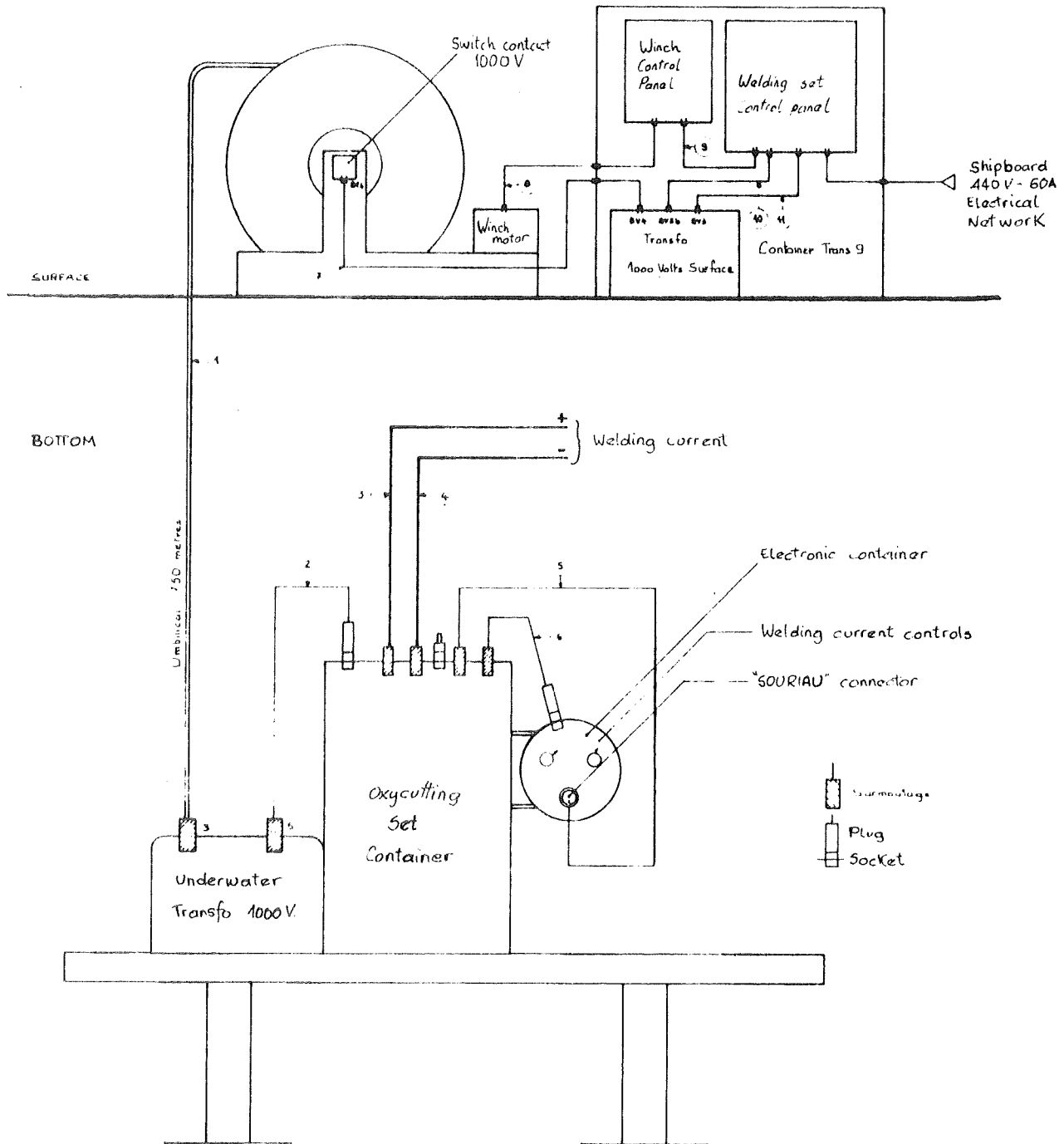

PHASE III

SCHEDULE OF ACTIVITIES FOR THE
PERIOD FROM 15 OCTOBER TO 29 OCTOBER 1977

SCHEDULE OF ACTIVITIES FOR THE PERIOD
FROM 15 OCTOBER TO 29 OCTOBER

I - SATURATION PROGRAM

DATE	TIME	EVENT
OCTOBER 15	9H45	COMPRESSION STARTS USING HELIOX 18/82
	9H49	COMPRESSION WITH PURE HELIUM
	10H22	PRESSURE DEPTH OF 150 METERS REACHED
	10H47	PURE NITROGEN COMPRESSION STARTS
	10H52	180 METER STOP
	11H59	PRESSURE DEPTH 200 METERS
	13H19	PURE NITROGEN COMPRESSION STARTS (238 METERS)
	13H21	240 METER STOP
	17H35	PURE NITROGEN COMPRESSION STARTS (298 METERS)
	17H43	300 METER STOP
	21H45	PETREL SAILS FROM MARSEILLES
	23H45	350 METER STOP

DATE	TIME	EVENT
OCTOBER 16	. 00H46 .	COMPRESSION RESUMED WITH PURE HELIUM
	. 09H44 .	400 METER STOP
	. 16H14 .	JANUS IV LIVING DEPTH OF 430 METERS REACHED
	. 20H30 .	BEGIN LOWERING WORK TABLE WITH DRILL PIPE
OCTOBER 17	. 09H00 .	DIVERS' REVEILLE
	. 09H35 .	OBSERVATION DIVE AT ATMOSPHERIC PRESSURE COMMANDANT GUYOT, DOCTOR FRUCTUS and MISTER DE RESSEGUIER.
	. 14H50 .	BELL PRESSURIZED
	. 15H20 .	POLYPENCO BREAKS IN THE BELL UMBILICAL (USED FOR READING THE PRESSURE INSIDE THE BELL).
	. 16H15 .	DIVE CANCELLED
OCTOBER 18	. 04H50 .	TEAM 1 REVEILLE : RAUDE-VERPEAUX-VIAL
	. 06H40 .	BELL CHECK LIST BEGINS FOR DIVE N° 1
	. 08H30 .	BELL CHECK LIST FINISHED FOR DIVE N° 1
	. 09H02 .	LOWERING OF BELL BEGINS
	. 09H47 .	PRESSURIZATION OF BELL BEGINS

DATE	TIME	EVENT
OCTOBER 18	10H07	450 METER WATER DEPTH REACHED
	10H15	HATCH DOOR IS OPENED
	10H42	DIVER JACQUES VERPEAUX LOCKS OUT
	11H17	VERPEAUX RETURNS TO BELL
	11H29	ELECTRICITY FAILS ON THE "PETREL"
	11H31	ELECTRICITY RETURNS
	12H07	DIVER GERARD VIAL LOCKS OUT
	12H20	VIAL RETURNS TO BELL
	12H32	HATCH DOOR IS CLOSED
	12H35	PRESSURIZATION OF BELL FROM 450 TO 460 METERS BEGINS
	12H38	END OF PRESSURIZATION OF THE BELL
	12H42	DECOMPRESSION FROM 460 TO 430 METERS BEGINS
	12H54	DECOMPRESSION TO 430 METERS ENDS
	13H15	BELL MATED TO CHAMBER
	13H20	HATCH PRESSURIZED
	14H55	BELL CHECK LIST BEGINS FOR DIVE N° 2
	15H37	CHECK LIST FINISHED FOR DIVE N° 2

DATE	TIME	EVENT
OCTOBER 18	16H06	BELL UNCLAMPED
	16H08	LOWERING OF BELL BEGINS
	16H35	PRESSURIZATION OF THE BELL BEGINS
	17H00	BOTTOM HATCH DOOR OPENED
	17H25	DIVER LOUIS SCHNEIDER LOCKS OUT
	17H50	PORTA-CUTTER PIPE-CUTTER MOUNTED
	18H00	HYDRAULIC POWER UNIT FAILS
	18H10	SCHNEIDER RETURNS TO BELL
	18H29	DIVER EMILE SEVELLEC LOCKS OUT
	18H46	SEVELLEC RETURNS TO BELL
	19H01	PRESSURIZATION OF BELL FROM 450 TO 460 METERS BEGINS
	19H03	460 METERS REACHED
	19H05	DECOMPRESSION FROM 460 TO 430 METERS BEGINS
	19H25	BELL ARRIVES AT THE SURFACE
	19H35	BELL CLAMPED TO CHAMBER
	19H50	BELL DEPRESSURIZED TO BE WORKED ON

DATE	TIME	EVENT
OCTOBER 19	. 05H00	. DIVERS' REVEILLE
	. 06H30	. BELL CHECK LIST BEGINS - DIVE N° 3
	. 09H01	. BELL UNCLAMPED
	. 09H05	. LOWERING OF BELL BEGINS
	. 09H34	. PRESSURIZATION OF BELL FROM 430 METERS TO 450 METERS BEGINS
	. 09H54	. 450 METERS REACHED
	. 10H00	. BOTTOM HATCH DOOR OPENED
	. 10H46	. DIVER PATRICK RAUDE LOCKS OUT
	. 10H50	. PIPE UNFASTENED FROM ITS SUPPORT
	. 11H08	. PIPE IS SHIFTED
	. 11H43	. COMECTOR AIR BAG IS INFLATED
	. 12H37	. COMECTOR LIFTED FROM ITS SUPPORT
	. 13H07	. RAUDE RETURNS TO BELL
	. 13H31	. DIVER GERARD VIAL LOCKS OUT VIAL RETURNS TO BELL
	. 14H38	. HATCH DOOR CLOSED
	. 14H41	. PRESSURIZATION OF BELL FROM 450 TO 460 METERS BEGINS

DATE	TIME	EVENT
OCTOBER 19	. 14H42 .	DECOMPRESSION FROM 460 TO 430 METERS BEGINS
	. 15H02 .	BELL REACHES SURFACE
	. 16H10 .	BELL CLAMPED
	. 16H35 .	BELL CHECK LIST BEGINS FOR DIVE N° 4
	. 17H25 .	CHECK LIST FINISHED
	. 18H05 .	HATCH DEPRESSURIZED
	. 18H06 .	BELL UNCLAMPED
	. 18H10 .	LOWERING OF BELL BEGINS
	. 18H35 .	PRESSURIZATION OF BELL FROM 430 TO 450 METERS BEGINS
	. 18H54 .	450 METERS REACHED
	. 18H55 .	BOTTOM HATCH DOOR OPENED
	. 19H11 .	DIVER PHILIPPE JEANTOT LOCKS OUT
	. 19H30 .	BEGINNING OF UNDERWATER WELDING
	. 19H44 .	UNDERWATER WELDING FINISHED
	. 19H46 .	JEANTOT RETURNS TO BELL (THE O-RING ON THE NON-RETURN VALVE OF THE MASK BECAME DISLODGED AND WATER ENTERED THE MASK).

DATE	TIME	EVENT
OCTOBER 19	20H23	DIVER EMILE SEVELLEC LOCKS OUT
	20H52	PIPE-CUTTING BEGINS
	21H13	CUTTING FINISHED
	21H18	SEVELLEC RETURNS TO BELL
	21H20	BOTTOM HATCH DOOR CLOSED
	21H22	PRESSURIZATION OF BELL FROM 450 TO 460 METERS BEGINS
	21H25	DECOMPRESSION FROM 460 TO 430 METERS BEGINS
	21H42	430 METERS REACHED
	21H45	BELL ARRIVES AT THE SURFACE
	21H48	BELL CLAMPED
	21H59	BELL DEPRESSURIZED TO BE WORKED ON
OCTOBER 20	08H00	REPRESSURIZATION OF BELL BEGINS
	09H10	BELL AT SAME PRESSURE AS CHAMBERS, 430 METERS
	09H58	BELL CHECK LIST BEGINS FOR DIVE N° 5
	10H43	BELL DEPRESSURIZED TO CHANGE AN AUTOMATIC VALVE

DATE	TIME	EVENT
OCTOBER 20	11H42	REPRESSURIZATION OF BELL BEGINS
	12H16	BELL AT SAME PRESSURE AS CHAMBERS
	13H08	CHECK LIST FINISHED
	13H31	HATCH DEPRESSURIZED
	13H34	BELL UNCLAMPED
	13H35	PRESSURIZATION OF BELL FROM 430 TO 490 METERS BEGINS
	15H05	489 METERS REACHED
	15H10	BOTTOM HATCH DOOR OPENED
	15H24	DIVER JACQUES VERPEAUX LOCKS OUT
	15H34	VERPEAUX RETURNS TO BELL
	15H51	DIVER GERARD VIAL LOCKS OUT
	16H01	VIAL RETURNS TO BELL
	16H09	PRESSURIZATION OF BELL FROM 489 TO 500 METERS BEGINS
	16H23	500 METERS REACHED
	16H24	DECOMPRESSION FROM 500 TO 430 METERS BEGINS
	17H25	430 METERS REACHED

DATE	TIME	EVENT
OCTOBER 20	17H32	BELL SURFACES
	17H38	BELL AT SAME PRESSURE AS CHAMBERS
	17H40	BELL CHECK LIST FOR DIVE N° 6 BEGINS
	18H20	CHECK LIST FINISHED
	18H46	BELL UNCLAMPED
	18H50	LOWERING OF BELL BEGINS
	19H14	PRESSURIZATION OF BELL FROM 430 TO 450 METERS BEGINS
	19H34	450 METERS REACHED
	19H35	INNER HATCH DOOR OPENED
	19H48	DIVER PHILIPPE JEANTOT LOCKS OUT
	21H05	COMECTOR INSTALLED ON ONE PIPE
	21H30	COMECTOR INSTALLED ON OTHER PIPE
	21H37	JEANTOT RETURNS TO BELL
	21H47	DIVER LOUIS SCHNEIDER LOCKS OUT
	22H35	STAFFA MOTOR INSTALLED
	23H17	SCHNEIDER RETURNS TO BELL
	23H18	BOTTOM HATCH DOOR CLOSED DECOMPRESSION FROM 460 TO 430 METERS BEGINS

DATE	TIME	EVENT
OCTOBER 20	. 23H50	. BELL SURFACES
	. 23H55	. BELL CLAMPED
OCTOBER 21	. 00H15	. BELL REACHES SAME PRESSURE AS CHAMBERS, 430 METERS.
	. 01H00	. RAISING OF WORK TABLE AND DRILL PIPE BEGINS
	. 05H00	. WORK TABLE AT 18 METERS' DEPTH
	. 06H07	. SURFACE DIVE FOR PHOTOS AND FILMS OF WORK TABLE AT 18 METERS
	. 08H27	. END OF SURFACE
	. 08H35	. WORK TABLE REACHES SURFACE
	.MORNING.	. RAISING OF BASE PLATE TO SUPPORT THE
	. AND	. PINGERS AND THE TAUT WIRELINE FOR THE
	AFTERNOON.	DYNAMIC POSITIONING SYSTEM.
	. 18H00	. "PETREL" SAILS FROM "JANUS IV" SITE
OCTOBER 22	. 00H24	. FINAL DECOMPRESSION BEGINS
	. 04H00	. 398 METERS REACHED
	. 08H00	. 379 METERS
	. 12H00	. 364 METERS
	. 20H00	. 336 METERS

DATE	TIME	EVENT
OCTOBER 23	. 04H00 .	311 METERS
	. 12H00 .	288 METERS
	. 20H00 .	267 METERS
OCTOBER 24	. 04H00 .	247 METERS
	. 12H00 .	229 METERS
	. 20H00 .	210 METERS
OCTOBER 25	. 04H00 .	191 METERS
	. 12H00 .	174 METERS
	. 20H00 .	157 METERS
OCTOBER 26	. 04H00 .	143 METERS
	. 12H00 .	129 METERS
	. 20H00 .	113 METERS
OCTOBER 27	. 04H00 .	97 METERS
	. 12H00 .	82 METERS
	. 20H00 .	70 METERS
OCTOBER 28	. 04H00 .	57 METERS
	. 12H00 .	42 METERS

DATE	TIME	EVENT
OCTOBER 28	20H00	30 METERS
OCTOBER 29	04H00	18 METERS
	08H25	PURE OXYGEN TAKEN BY BREATHING MASKS BY LOUIS SCHNEIDER AND PATRICK RAUDE DURING TWO 25-MINUTE PERIODS WITH 5 MINUTES' REST IN BETWEEN
	09H25	END OF USE OF OXYGEN MASKS
	12H00	7 METERS' DEPTH
	16H00	25 MINUTES OF PURE OXYGEN ADMINISTERED BY MASK TO ALL DIVERS AT A PRESSURE DEPTH OF 2.5 METERS
	17H00	OXYGEN ADMINISTERED TO ALL DIVERS BY MASK FOR 25 MINUTES
	17H33	END OF DECOMPRESSION ; DIVERS ARRIVE AT ATMOSPHERIC PRESSURE IN GOOD PHYSICAL CONDITION.
		DIVERS EXIT FROM THE CHAMBERS.

II - SCHEDULE FOR LAUNCHING AND LOWERING THE WORK TABLE

Sunday 16 October 1977

MANEUVER

- 06H00 . (The table is transported suspended over the moon-pool from the drill pipe by temporary 8-meter slings). Seizing is removed from the table and anchor.
- . (The anchor weight is transported on the cellar deck, next to the moon-pool.) The table is raised 4 meters by the derrick.
- . The Hydroland winch ropes (one winch is fore and one aft of the moon-pool) are shackled to either end of the anchor weight.
- . The two snatch blocks under the drill floor are positioned directly over the ends of the anchor so it can be raised evenly by the winches.
- 09H00 . The winch ropes are hauled in simultaneously to raise the anchor so the trolley can be removed.
- . The moon-pool trolley is removed with another winch.
- . The anchor is raised to the maximum height permitted by the position of the table.
- 09H30 . The moon-pool doors are opened.
- . The anchor is lowered (both winches paid out simultaneously) until its weight is taken over by the table, under surveillance by a surface diver.
- 10H15 . When the anchor weight is suspended under the table :
- the two winches are given slack
 - the surface diver unshackles the two winch ropes and they are hauled in.

- 11H00 . The table is lowered to 50 cm below the top of the cellar deck and short temporary slings are attached to the four corners.
- . These slings are lashed to the four corner lugs of the moon-pool.
- 13H00 . The table is lowered until the 4 short slings are taut.
- . The four 8-meter slings are then unshackled from the drill pipe and table.

WAITING FOR THE SUBMARINE TO LOCATE THE 500 METER SITE

Installing the spreader beam :

- . The four 6-meter slings are attached to the work table.
- . The cross bar is brought toward the moon-pool by the forward starboard crane.
- . The cross bar is positioned over the work table by the two Hydroland winches.
- 19H00 . The 8-meter slings are shackled from the drill pipe to the cross bar.
- 20H00 . The 6-meter slings are shackled from the table to the cross bar.
- . The entire assembly is checked for proper preparation and shackling.
- . The drill pipe is raised until the weight of the table is taken over by the lifting sub.
- . The umbilical is attached to the drill pipe so it will not hinder the divers.
- . The pan and tilt unit is mounted on the stand.
- . The work table check list is run through.
- . The table is raised to unshackle the temporary short slings binding it to the corners of the moon-pool.
- 20H30 . The slings are unshackled.

- . The hydraulic power pack on the work table is started up.
- . The table is lowered until the lifting sub is level with the cellar deck. (The umbilical is lowered with the table).
- . The moon-pool doors are closed and the grating put in place.
- . The umbilical is hooked to the drill pipe lifting sub.

Lowering the work table :

- . The table is lowered until the lifting sub is under the moon-pool, clear of the ship's hull. A diver is in attendance in the water.
- 21H00 . The guide-line arms (for the diving bell guide lines) are extended from the work table and locked (see appendix).
- . Guide lines are put in place at the ends of the arms and shackles locked.
 - . The table is lowered with a halt about every 27 meters to attach the umbilical to the drill pipe.

Depositing the anchor weight on the sea bed :

- . Weight of the ensemble is checked at the drill floor level on the Martin Decker machine
- . The heave compensator is turned on.
- . The hydraulic power pack on the table is turned off
- . An observation dive is made to check :
 - the position of the table
 - the condition of the umbilical on the drill string and its arrival on the table
 - lowering and raising times for the bell

- the general condition of the equipment on the table
- the retrieval procedure for the bell in case of emergency

MONDAY OCTOBER 17, 1977

04H30 . 460 meters reached.

LEGEND "PETREL" AND WORK
TABLE.

1. SURFACE HYPERBARIC COMPLEX
2. DRILLING MOON POOL
3. DIVING MOON POOL
4. DRILL PIPE STRING
5. O₂ UMBILICAL FOR UNDERWATER
PIPECUTTING.
6. HYDRAULIC POWER PACK AND TV
CAMERA UMBILICAL
7. UNDERWATER WELDING SET
SUPPLY UMBILICAL
8. WIRELINES FOR DYNAMIC
POSITIONING SYSTEM
9. 2 GUIDE LINES FOR BELL
10. BELL ELECTRO-MECHANICAL
CABLE.
11. BELL UMBILICAL
12. BASE PLATE WITH 2 PINGERS
FOR ACOUSTIC POSITIONING
OF "PETREL".
13. ANCHOR FOR TENSIONING
- 450 m
WORK TABLE AND OPERATING
- 460 m
HEAVE COMPENSATOR.

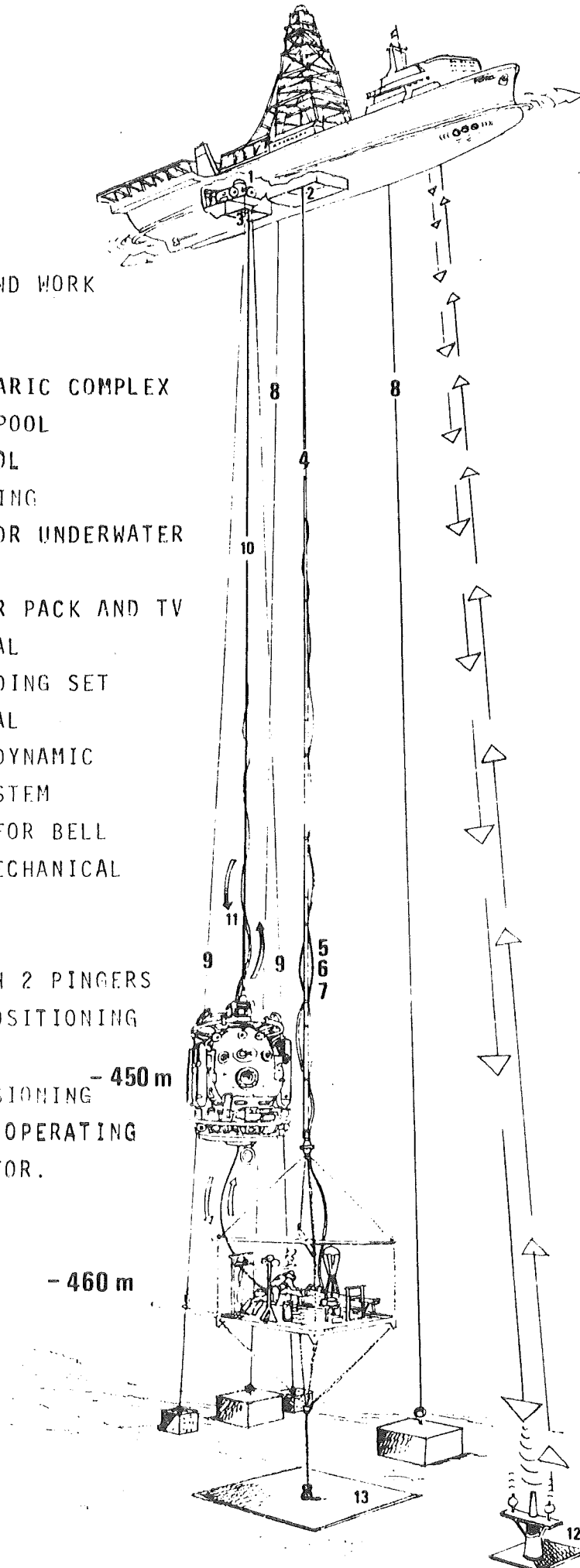

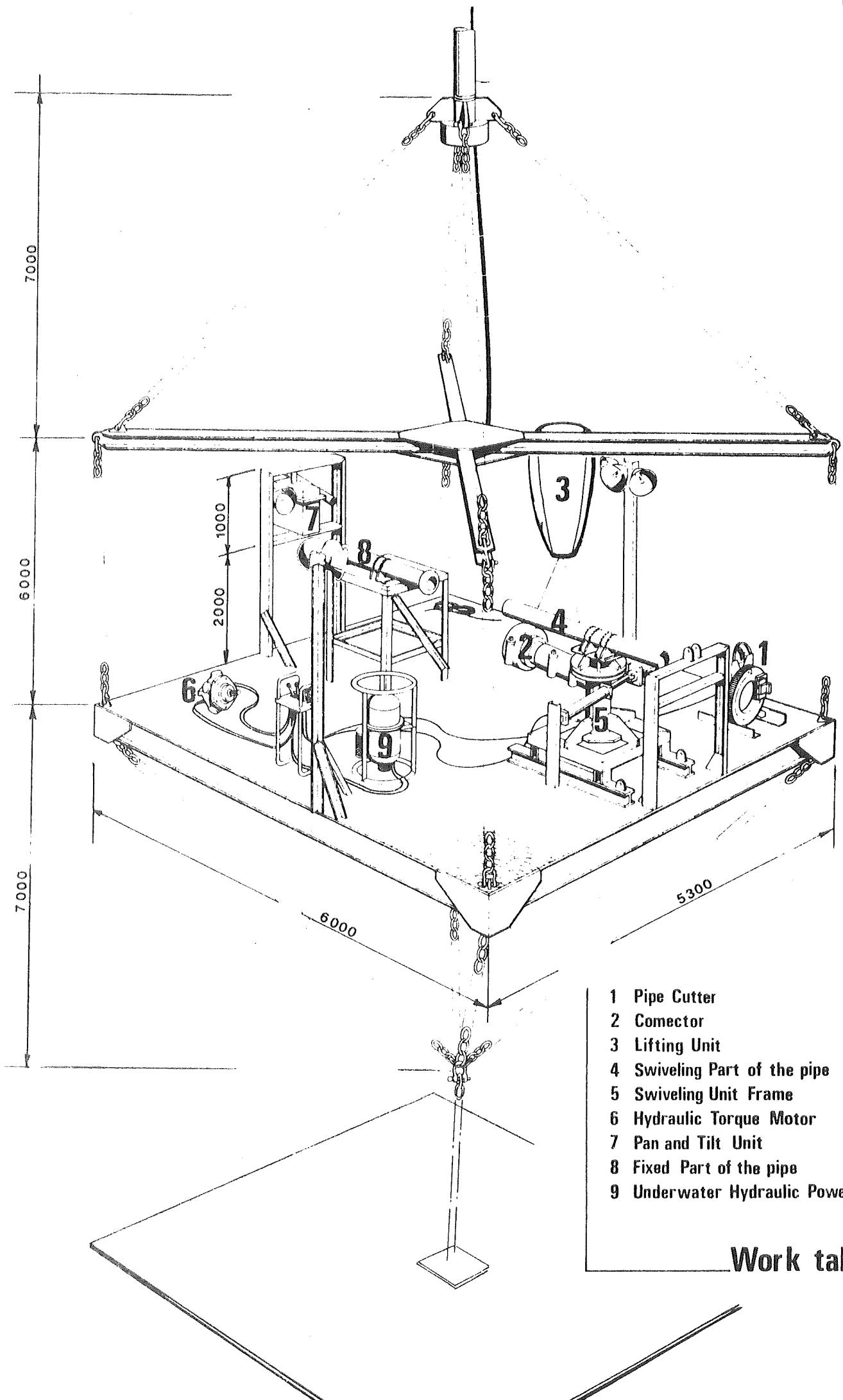

- COMPRESSION PHASE

The compression phase began on Saturday October 15th at 9:45 a.m. and ended Sunday October 16th at 3:45 p.m. when the storage pressure level equivalent to a depth of 430 meters was reached.

The compression profile is shown on p. 111 and the environmental parameter curves for the compression period on p. 112 .

Upon arrival at the living depth the composition of the atmosphere in the chambers was as follows :

Oxygen	;	O ₂	pp = 0.4 bars
Nitrogen	:	N ₂	pp = 1.6 bars
Helium	:	He	pp = 42 bars

This composition was maintained during the entire saturation at 430 meters.

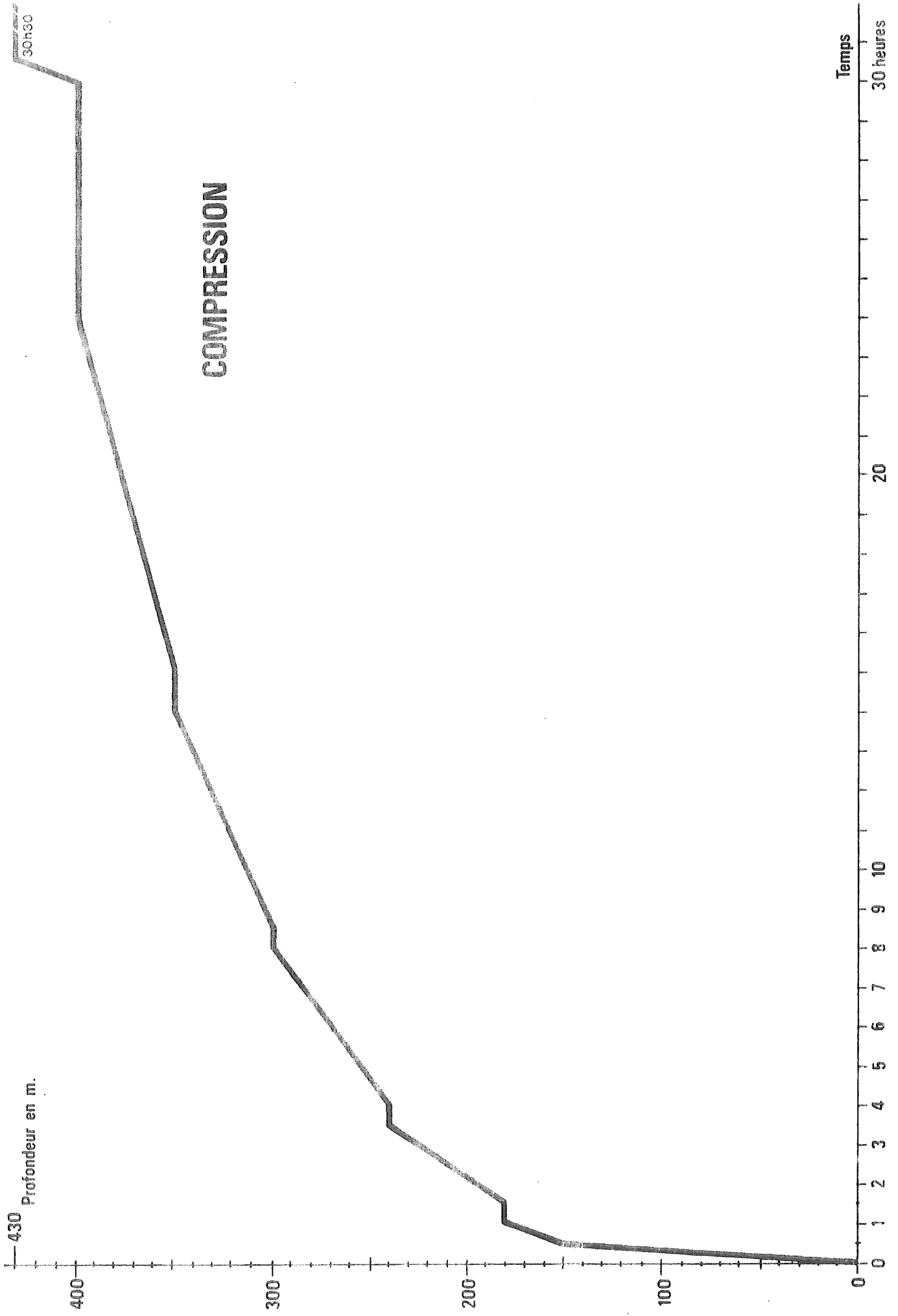

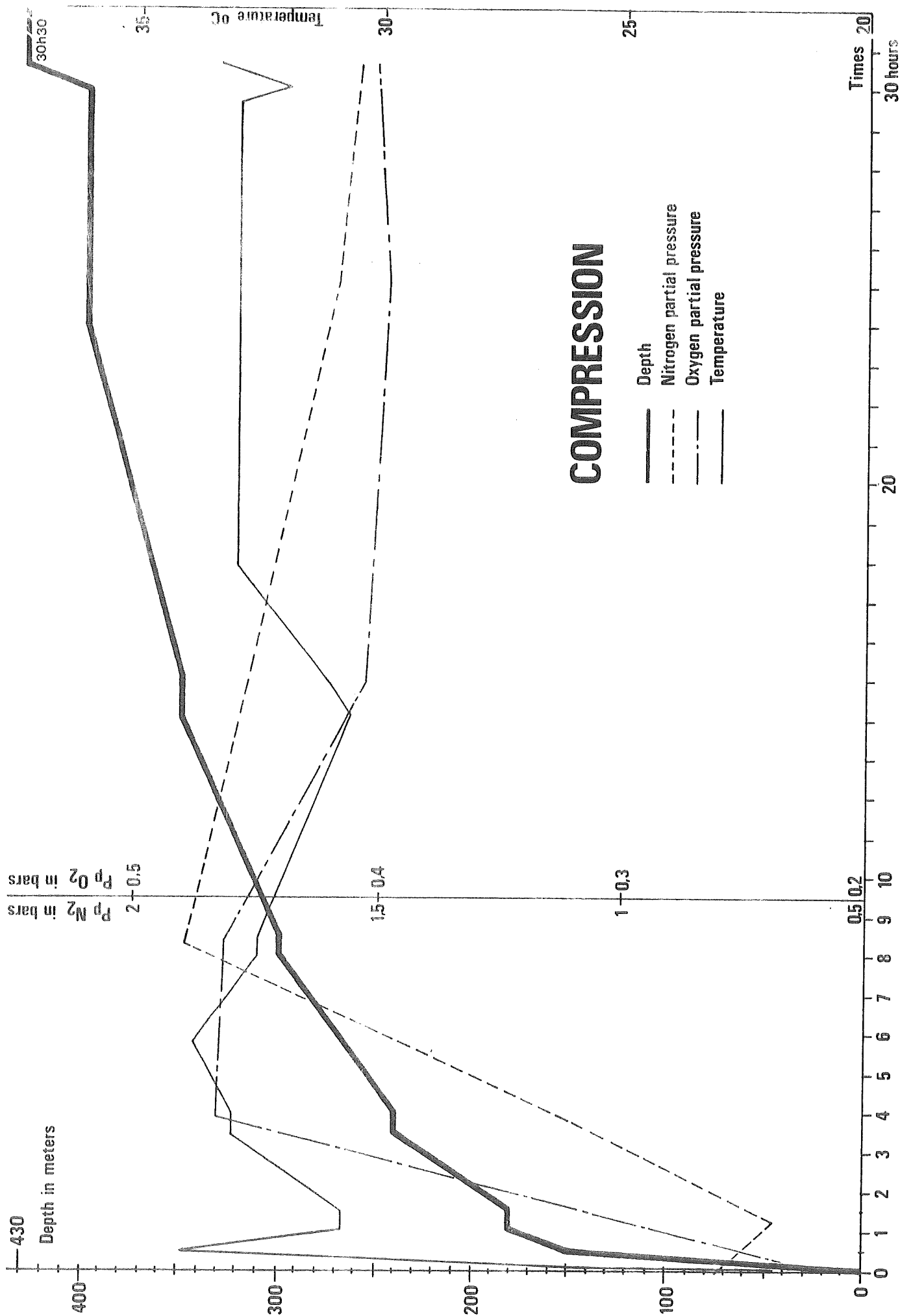

SUMMARY OF COMPRESSION TABLE

LENGHT OF TIME	FROM	TO	PRESSURIZATION GAS
00H02	0 meter	10 meters	20/80 hélíox
00H28	10 meters	150 meters	pure hélíum
00H28	150 meters	178 meters	pure hélíum
00H02	178 meters	180 meters	pure nitrogen
00H30	180 meters	180 meters	
01H56	180 meters	238 meters	pure hélíum
00H04	238 meters	240 meters	pure nitrogen
00H30	240 meters	240 meters	
03H52	240 meters	298 meters	pure hélíum
00H08	298 meters	300 meters	pure nitrogen
00H30	300 meters	300 meters	
05H20	300 meters	348 meters	pure hélíum
00H13	348 meters	350 meters	pure nitrogen
01H00	350 meters	350 meters	
08h57	350 meters	400 meters	pure hélíum
06H00	400 meters	430 meters	
00H30	400 meters	430 meters	pure hélíum

PHASE III

DIVING PHASE

- DIVING PHASE

I - GENERAL REPORT

The diving program was supposed to begin the morning of Monday October 17th.

Technical problems with the umbilical delayed the diving program for one day.

The polypenco components did not withstand the pressure limits required, thus precluding certain umbilical functions such as pressure sampling of the bell atmosphere.

Another umbilical was assembled on the spot and used for all of the dives.

The six dives took place on October 18,19 and 20. Reports and analyses of the dives are given in the following pages.

Due to the physical, psychological and mental fitness of the divers the extra record depth of 501 meters was attained during one exceptional dive, the fifth.

Environmental parameters were analyzed for each dive and these are also included in the following pages along with the time duration.

In accordance with the usual practice on Comex worksites, checklists and emergency procedures were drawn up and used.

The checklists used for each dive will be found on pages 136 - 140 inclusive. The emergency procedures given on pages 141-142 cover the following eventualities :

- communications failure
- electrical failure
- break in electro-mechanical cable
- break in surface-bell umbilical

D I V E I

DIVING REPORT / RAPPORT DE PLONGÉE

DIVE
Plongée N° I

DATE : 18 OCTOBRE 1977

DIVING SUPERVISOR : NOGUERRA Pierre
Chef de plongée

DIVER 1 } VERPEAUX Jacques
Plongeur 1 }

DIVER 2 } VIAL Gérard.
Plongeur 2 }

BELL-MAN : RAUDE Patrick

	TIME / Temps	DÉPTH Profondeur
START OF COMPRESSION <i>Début compression</i>	09H. 47	430 m
END OF COMPRESSION <i>Fin compression</i>	10H. 07	450 m
START OF DECOMPRESSION <i>Début décompression</i>	12H. 53	460 m
END OF DECOMPRESSION <i>Fin décompression</i>	13H. 09	430 m

DURATION OF THE DIVE
TEMPS DE PLONGÉE

02H. 55

DIVER 1 / PLONGEUR 1

TIME / Temps	10H45	10H49	10H56	11H07								
WATER / Eau	42°	42°	42°	42°								
BREATHING RATE OF DIVER / PER MINUTE <i>Rythme respiratoire Plongeur / minute</i>	18	20	20	16								

WORK PERFORMED / Travail effectué
FIRST DIVE ON THE WORK TABLE AT 460 METRES.

	BEGINNING	END
WATER TEMPERATURE <i>Température de l'eau</i>	13°2 C	
	<i>Début</i>	<i>Fin</i>

PREMIERE PLONGEE A 460 METRES SUR LA TABLE
DE TRAVAIL.

TIME SPENT IN WATER
Temps total dans l'eau

00H. 35

DIVER 2 / PLONGEUR 2

TIME / Temps	12H05	12H10	12H15									
WATER / Eau	42°	42°	42°									
BREATHING RATE OF DIVER / PER MINUTE <i>Rythme respiratoire Plongeur / minute</i>	12	12	14									

WORK PERFORMED / Travail effectué
A LEAK ON THE FACE-MASK SEAL INTERRUPTED THIS
DIVE.

	BEGINNING	END
WATER TEMPERATURE <i>Température de l'eau</i>	13°2 C	
	<i>Début</i>	<i>Fin</i>

UNE FUITE AU NIVEAU DE L'ETANCHEITE DU MASQUE
FACIAL INTERROMPT CETTE PLONGEE.

TIME SPENT IN WATER
Temps total dans l'eau

00H. 13

Depth in metres
Profondeur en mètres

501

490

470

460

450

430

0

10

60

120

180

240

300

360

Dive 1 Plongée

in water time

avec intervention dans l'eau

Jacques VERPEAUX
Gerard VIAL

: 35 minutes
: 13 minutes

Time elapsed
Temps

Real time
Horaire

Start pressurization
Début pressurisation

09h.47.

Reached 450m
Arrivée à 450m

20 mn

10h.07

Diver 1 locked out
Plongeur 1 à l'eau

55 mn

10h.42

Diver 1 returned
Retour du plongeur 1

90 mn

11h.17

Diver 2 locked out
Plongeur 2 à l'eau

140 mn

12h.07

Diver 2 returned
Retour du plongeur 2

153 mn

12h.20

Start pressurization
Début pressurisation

168 mn

12h.35

Reached 460 m
Arrivée à 460 m

171 mn

12h.38

Start decompression
Début décompression

175 mn

12h.42

Reached 430 m
Arrivée à 430 m

187 mn

12h.54

Time in minutes / Temps en minutes

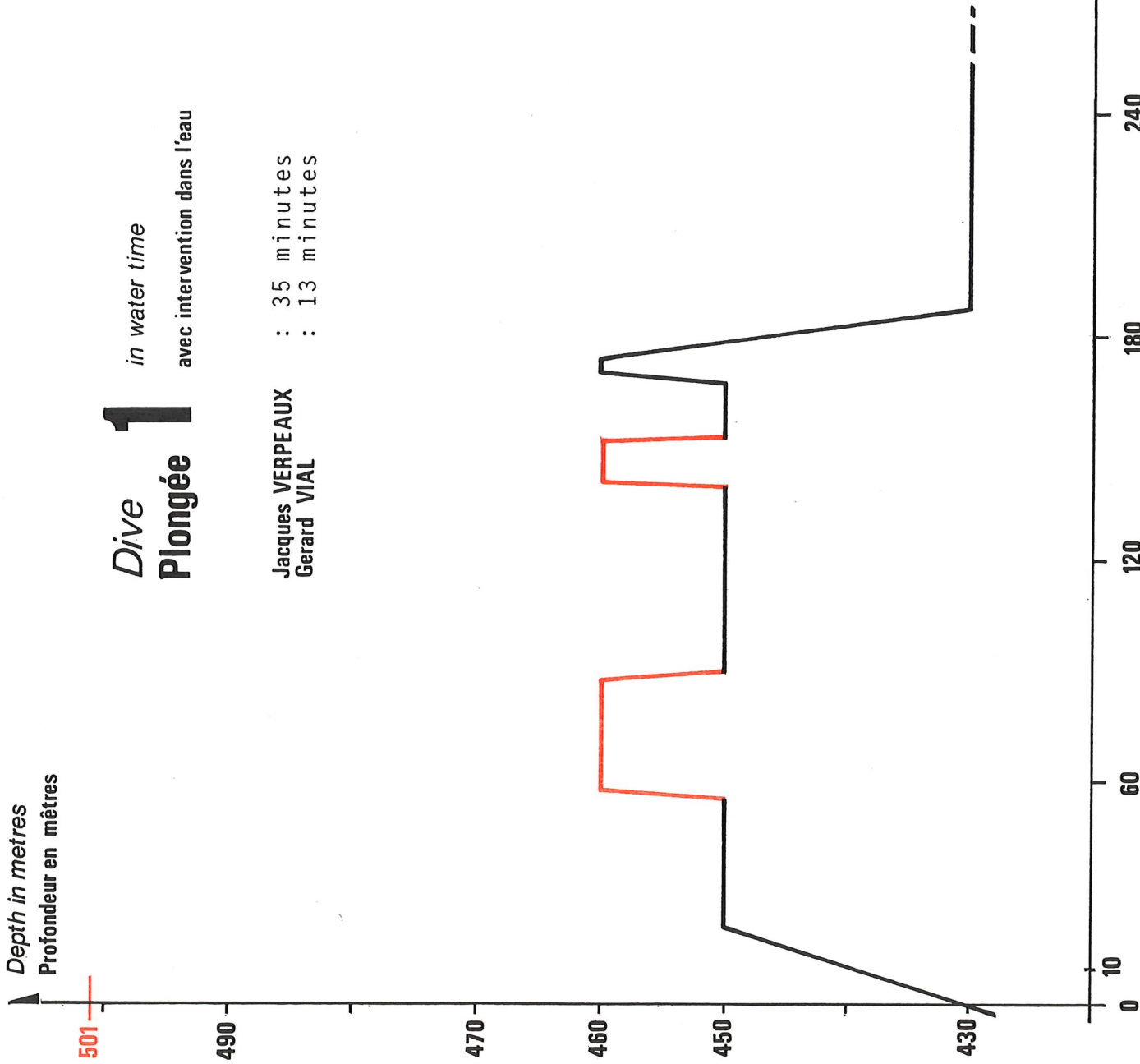

DIVE 1

Plongée 1

BELL'S ENVIRONMENTAL PARAMETERS

- Pp CO₂ : Carbon dioxide partial pressure
- - - Pp O₂ : Oxygen partial pressure
- Depth

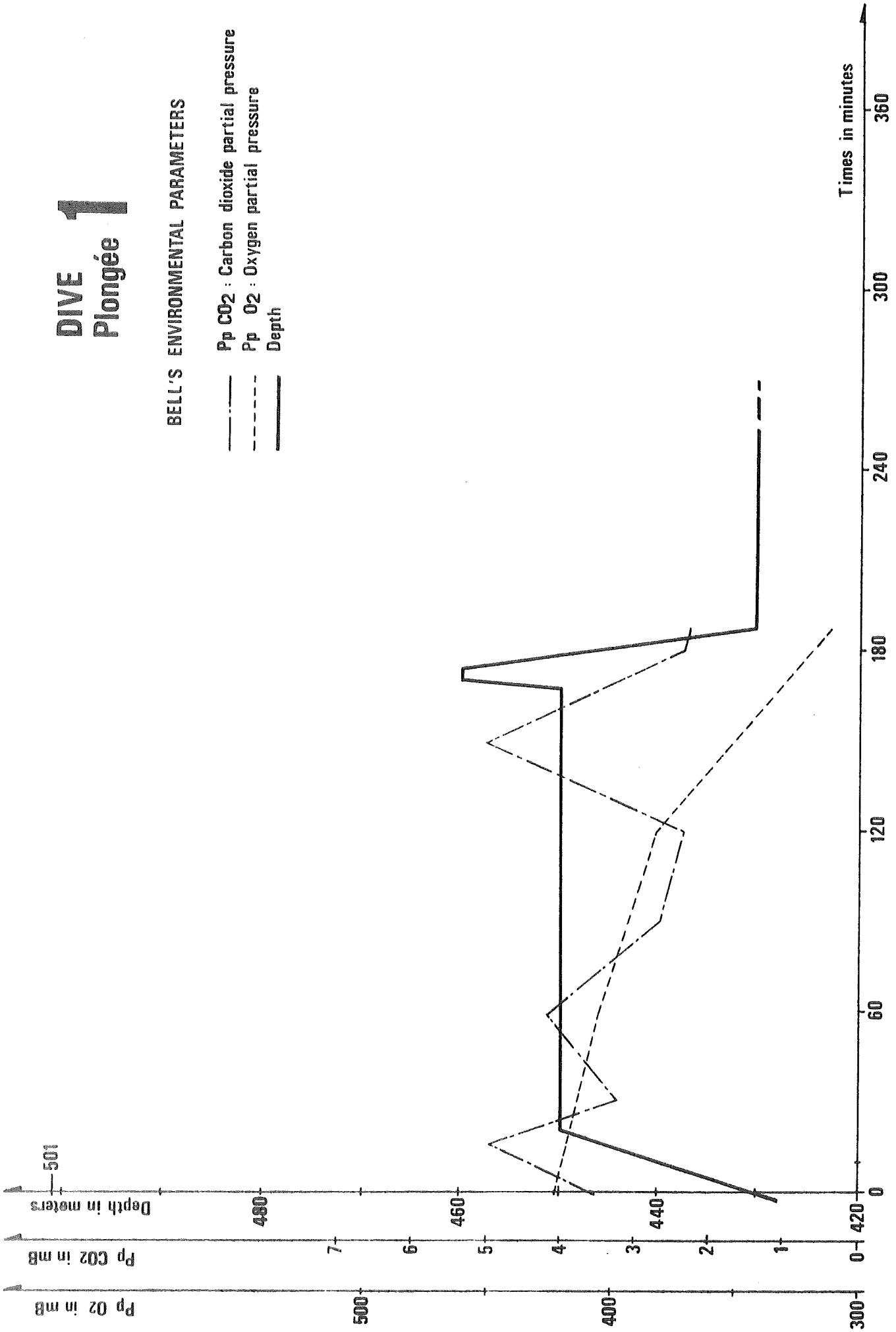

D I V E I I

DIVING REPORT / RAPPORT DE PLONGÉE

DIVE
Plongée N° II

DATE : 18 OCTOBRE 1977

DIVING SUPERVISOR : CROZIER Jacques
Chef de plongée

DIVER 1 } SCHNEIDER Louis
Plongeur 1 }

DIVER 2 } SEVELLEC Emile
Plongeur 2 }

BELL-MAN : JEANTOT Philippe

	TIME / Temps	DEPTH Profondeur
START OF COMPRESSION <i>Début compression</i>	16 H. 35	430 m
END OF COMPRESSION <i>Fin compression</i>	16 H. 55	450 m
START OF DECOMPRESSION <i>Début décompression</i>	19 H. 05	460 m
END OF DECOMPRESSION <i>Fin décompression</i>	19 H. 21	430 m
DURATION OF THE DIVE TEMPS DE PLONGÉE		02 H. 30

DIVER 1 / PLONGEUR 1

TIME / Temps	17H20	17H25	17H50								
WATER / Eau	42° C	42° C	42° C								
BREATHING RATE OF DIVER / PER MINUTE <i>Rythme respiratoire Plongeur / minute</i>	15	14	10								

WORK PERFORMED / *Travail effectué*
ATTEMPT TO LOCATE THE PIPE-CUTTER. FAILURE ON
HYDRAULIC PUMP.

ESSAIS DE MISE EN PLACE DU COUPE-TUBE. PANNE
DE LA CENTRALE HYDRAULIQUE.

	BEGINNING	END
WATER TEMPERATURE <i>Température de l'eau</i>	13°2 C	
	<i>Début</i>	<i>Fin</i>

TIME SPENT IN WATER
Temps total dans l'eau

00 H. 45

DIVER 2 / PLONGEUR 2

TIME / Temps	18H27	18H35	18H40								
WATER / Eau	42° C	42° C	42° C								
BREATHING RATE OF DIVER / PER MINUTE <i>Rythme respiratoire Plongeur / minute</i>	18	20	20								

WORK PERFORMED / *Travail effectué*
PIPE-CUTTER REMOVED FROM PIPE AND RELOCATED ON

WORK TABLE.

COUPE TUBE ENLEVE DU PIPE LINE ET FIXE SUR LA
TABLE DE TRAVAIL.

	BEGINNING	END
WATER TEMPERATURE <i>Température de l'eau</i>	13°2C	
	<i>Début</i>	<i>Fin</i>

TIME SPENT IN WATER
Temps total dans l'eau

00 H. 17

Depth in metres
Profondeur en mètres

501

Dive 2 Plongée 2

in water time

avec intervention dans l'eau

Louis SCHNEIDER
Emile SEVELLEC

: 45 minutes
: 17 minutes

Time elapsed
Temps

Real time
Horaire

Start pressurization
Début pressurisation

16h.35

Reached 450m
Arrivée à 450m

16h.55

Diver 1 locked out
Plongeur 1 à l'eau

17h.25

Diver 1 returned
Retour du plongeur 1

18h.10

Diver 2 locked out
Plongeur 2 à l'eau

18h.29

Diver 2 returned
Retour du plongeur 2

18h.46

Start pressurization
Début pressurisation

18h.57

Reached 460 m
Arrivée à 460 m

19h.03

Start decompression
Début décompression

19h.05

Reached 430 m
Arrivée à 430 m

19h.21

Time in minutes / Temps en minutes

360

300

240

180

120

60

10

0

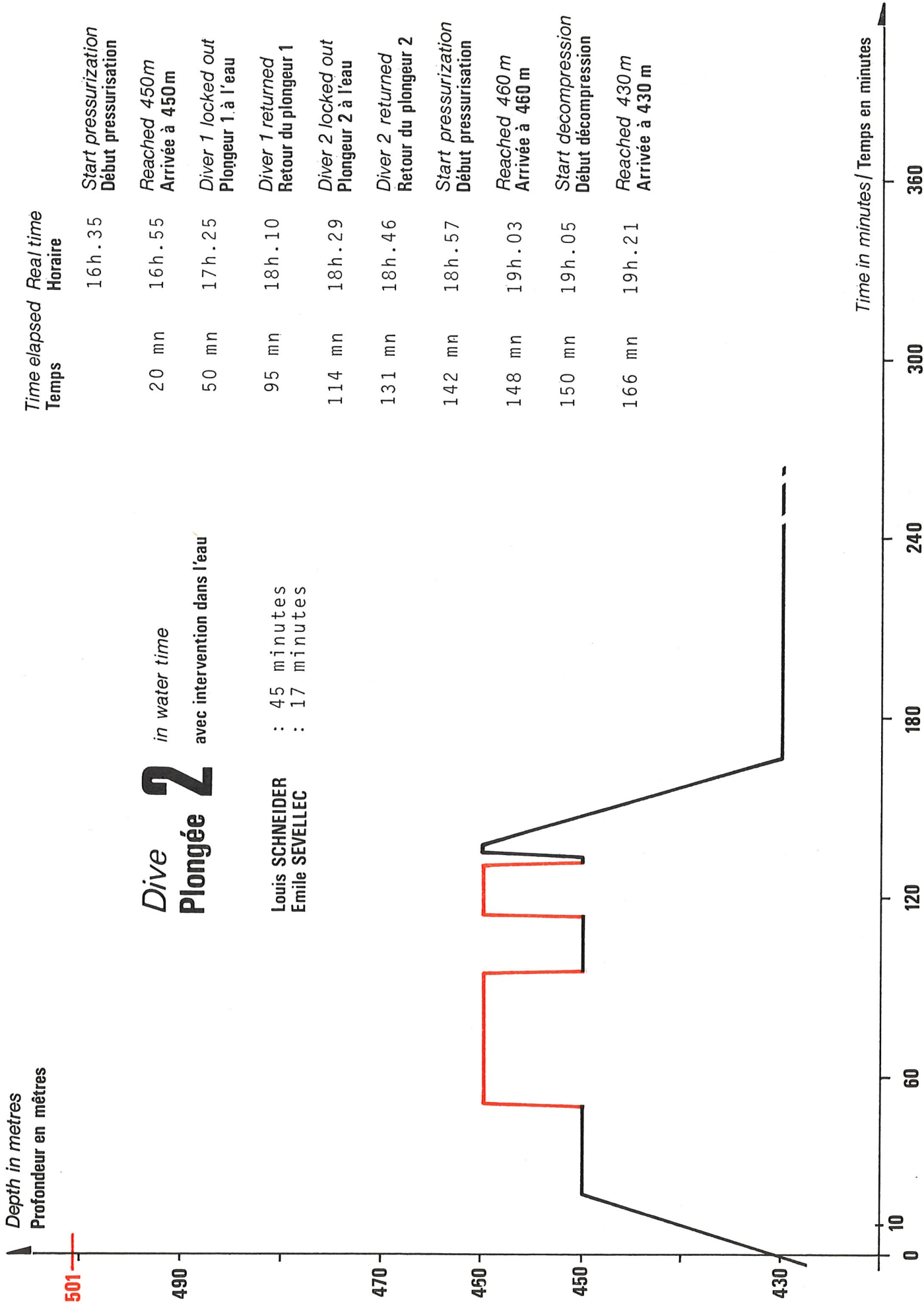

DIVE 2

Plongée 2

BELL'S ENVIRONMENTAL PARAMETERS

- Pp CO₂ : Carbon dioxide partial pressure
- - - Pp O₂ : Oxygen partial pressure
- Depth

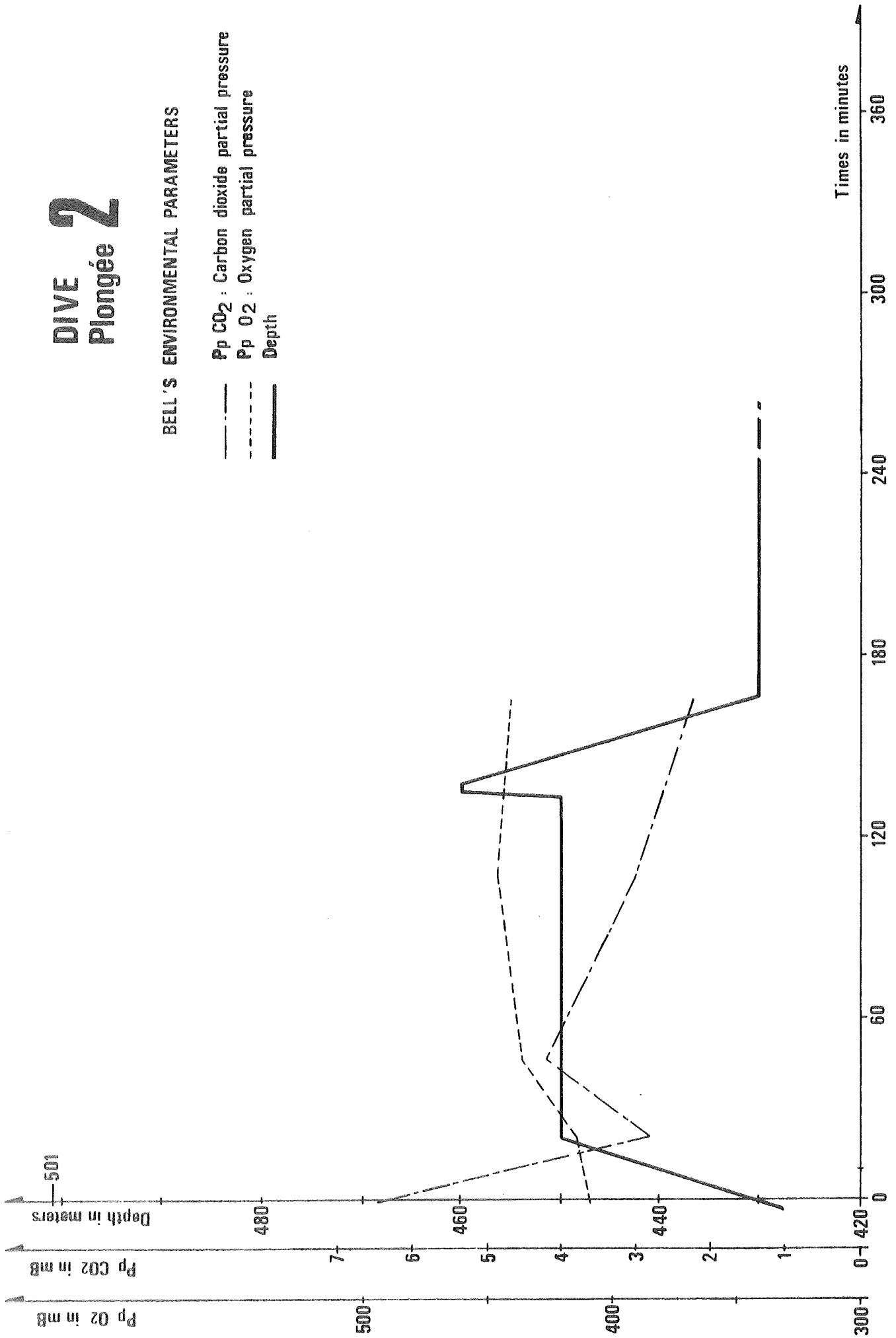

D I V E I I I

DIVING REPORT / RAPPORT DE PLONGÉE

DIVE Plongée N° III

DATE : 19 OCTOBRE 1977

DIVING SUPERVISOR : NOGUERRA Pierre
Chef de plongée

DIVER 1 } RAUDE Patrick
Plongeur 1

DIVER 2 } VIAL Gérard
Plongeur 2

BELL-MAN : VERPEAUX Jacques

	TIME / Temps	DEPTH Profondeur
START OF COMPRESSION <i>Début compression</i>	09 H. 34	430 m
END OF COMPRESSION <i>Fin compression</i>	09 H. 54	450 m
START OF DECOMPRESSION <i>Début décompression</i>	14 H. 42	460 m
END OF DECOMPRESSION <i>Fin décompression</i>	16 H. 06	430 m
DURATION OF THE DIVE <i>TEMPS DE PLONGÉE</i>		05 H. 08

DIVER 1 / PLONGEUR 1

TIME / Temps	11H00	11H10	11H15	11H25	11H30	11H35	11H40	11H46	12H09	12H22	12H46	13H03
WATER / Eau	44° C	44° C	44° C	44° C	44° C	44° C	44° C	44° C	44° C	44° C	44° C	44° C
BREATHING RATE OF DIVER / PER MINUTE <i>Rythme respiratoire Plongeur / minute</i>	18	24	20	20	20	24	20	26	20	24	28	24

WORK PERFORMED / *Travail effectué*
 THE PIPE IS LOOSEMED FROM ITS BRACKET AND SHIFED USING THE LIFTING BAG.
 LE PIPE EST DESSERE DE SON SUPPORT PUIS RIPE, LE COMECTOR EST DEPLACE A L'AIDE D'UN PARACHUTE.

	BEGINNING	END
WATER TEMPERATURE <i>Température de l'eau</i>	13°2 C	
	<i>Début</i>	<i>Fin</i>

TIME SPENT IN WATER
Temps total dans l'eau 02 H. 21

DIVER 2 / PLONGEUR 2

TIME / Temps	13H31	14H00	14H20									
WATER / Eau	44° C	44° C	44° C									
BREATHING RATE OF DIVER / PER MINUTE <i>Rythme respiratoire Plongeur / minute</i>	10	12	14									

WORK PERFORMED / *Travail effectué*
 THE COMECTOR IS SECURED ON THE WORK TABLE AS THE HEAVE IS TOO GREAT TO LOCATE THE CONNECTOR THE PIPE.
 LE COMECTOR EST ARRIME SUR LA TABLE DE TRAVAIL PIONNEMENT ETANT TROP IMPORTANT POUR POUVOIR MBOITER LE CONNECTEUR DANS LE PIPE.

	BEGINNING	END
WATER TEMPERATURE <i>Température de l'eau</i>	13°2 C	
	<i>Début</i>	<i>Fin</i>

TIME SPENT IN WATER
Temps total dans l'eau 01 H. 00

Depth in metres
Profondeur en mètres

501

Dive 3

in water time
avec intervention dans l'eau

Patrick RAUDE : 02h.21
Gerard VIAL : 01h.00

Time elapsed
Temps

Real time
Horaire

Time elapsed Temps	Real time Horaire
297 mn	14h.31
307 mn	14h.41
307 mn	14h.41
308 mn	14h.42
392 mn	16h.06

Start pressurization Début pressurisation	Diver 2 returned Retour du plongeur 2
Reached 450m Arrivée à 450m	Start pressurization Début pressurisation
Diver 1 locked out Plongeur 1 à l'eau	Reached 460 m Arrivée à 460 m
Diver 1 returned Retour du plongeur 1	Start decompression Début décompression
Diver 2 locked out Plongeur 2 à l'eau	Reached 430 m Arrivée à 430 m

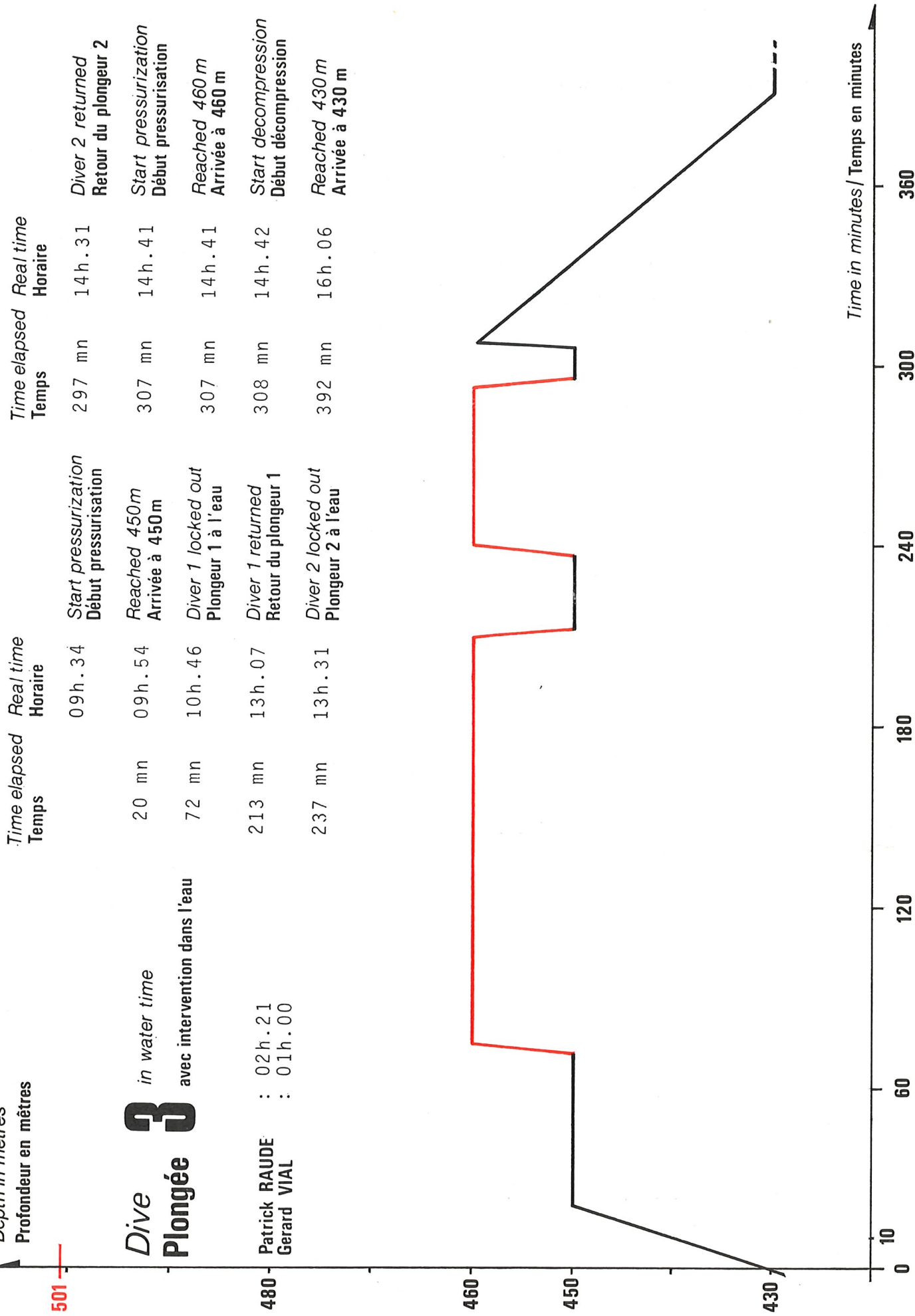

Time in minutes / Temps en minutes

DIVE 3

Plongée 3

BELL'S ENVIRONMENTAL PARAMETERS

- Pp CO₂ : Carbon dioxide partial pressure
- - - Pp O₂ : Oxygen partial pressure
- Depth

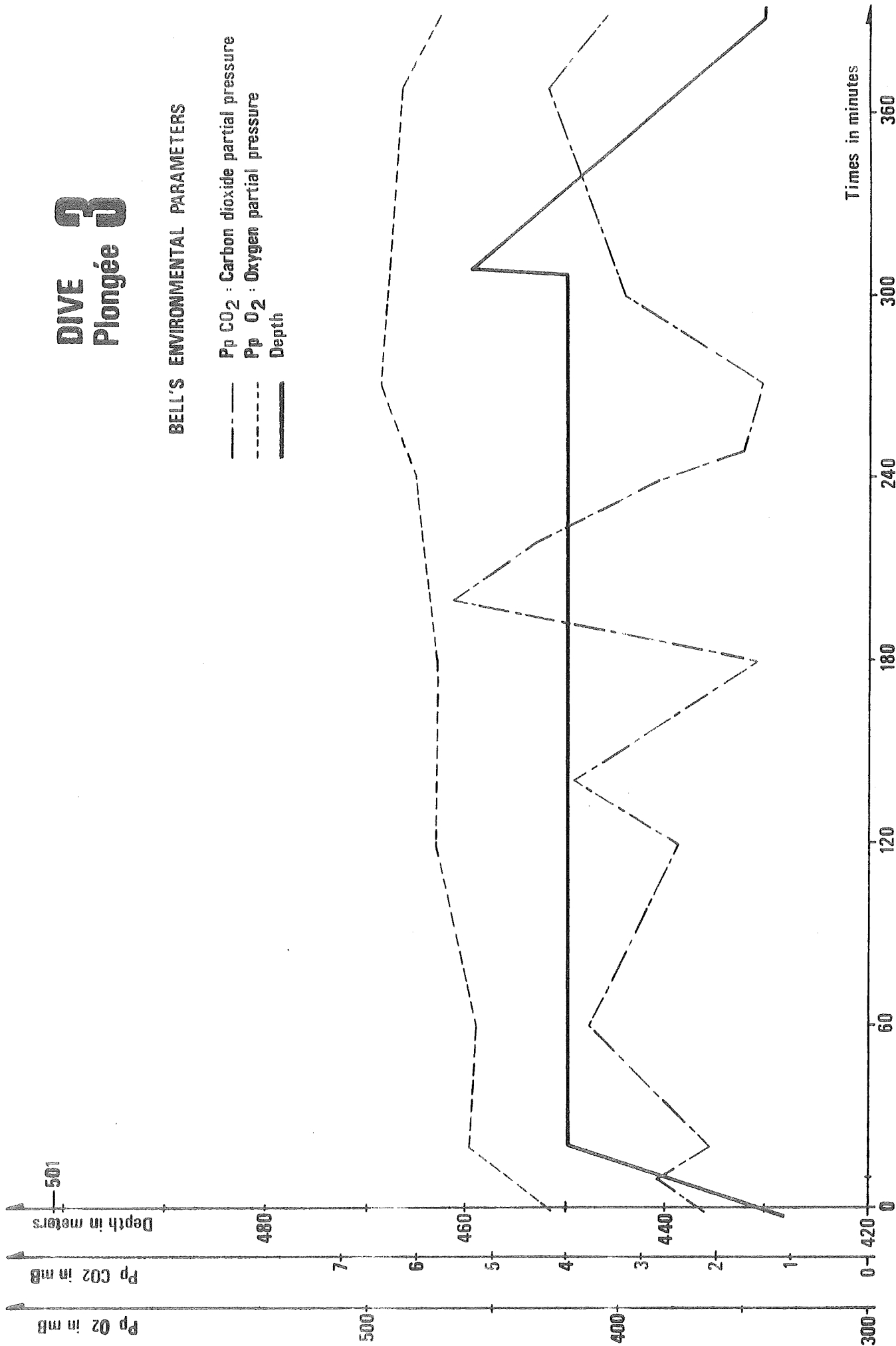

D I V E I V

JANUS IV

DIVING REPORT / RAPPORT DE PLONGÉE

DIVE N° IV
Plongée

DATE : 19 OCTOBRE 1977

DIVING SUPERVISOR : CROZIER Jacques
Chef de plongée

DIVER 1 } JEANTOT Philippe
Plongeur 1 }

DIVER 2 } SEVELLEC Emile
Plongeur 2 }

BELL-MAN : SCHNEIDER Louis

	TIME / Temps	DEPTH / Profondeur
START OF COMPRESSION <i>Début compression</i>	18 H 35	430 m
END OF COMPRESSION <i>Fin compression</i>	18 H 54	450 m
START OF DECOMPRESSION <i>Début décompression</i>	21 H 25	460 m
END OF DECOMPRESSION <i>Fin décompression</i>	21 H 42	430 m

DURATION OF THE DIVE <i>TEMPS DE PLONGÉE</i>	
	2 H 50

DIVER 1 / PLONGEUR 1

TIME / Temps	19H25	19H35										
WATER / Eau	43	43										
BREATHING RATE OF DIVER / PER MINUTE <i>Rythme respiratoire Plongeur / minute</i>	14	12										

WORK PERFORMED / Travail effectué

IN THE "WET" WELDING TRIALS. DIVE INTERRUPTED
OWING TO THE FAILURE OF AN "O" RING ON THE FACE
MASK'S CHECK VALVE.

	BEGINNING	END
WATER TEMPERATURE <i>Température de l'eau</i>	13°2 C	
	<i>Début</i>	<i>Fin</i>

ESSAIS DE SOUDAGE EN PLEINE EAU. PLONGEE INTERROMPUE
PAR SUITE D'UNE RUPTURE DU JOINT THORIQUE DU CLAPET
ANTI-RETOUR PLACE SUR LE MASQUE FACIAL.

TIME SPENT IN WATER
Temps total dans l'eau

0 H 35

DIVER 2 / PLONGEUR 2

TIME / Temps	20H24	20H30	20H38	20H45								
WATER / Eau	43	43	45	45								
BREATHING RATE OF DIVER / PER MINUTE <i>Rythme respiratoire Plongeur / minute</i>	20	19	19	20								

WORK PERFORMED / Travail effectué

OXY-ARC CUTTING TRIALS IN THE "WET"
ESSAIS DE DECOUPAGE OXY-ARC EN PLEINE EAU.

	BEGINNING	END
WATER TEMPERATURE <i>Température de l'eau</i>	13°2 C	
	<i>Début</i>	<i>Fin</i>

TIME SPENT IN WATER
Temps total dans l'eau

0 H 55

Depth in metres
Profondeur en mètres

501

490

470

460

450

430

10

0

Dive 4 Plongée 4

in water time

avec intervention dans l'eau

Philippe JEANTOT

: 35 minutes

Emile SEVELLEC

: 55 minutes

Time elapsed
Temps

18h.35

19 mn

19h.11

73 mn

20h.23

110 mn

21h.18

165 mn

21h.22

169 mn

21h.24

171 mn

21h.25

172 mn

21h.42

189 mn

Start pressurization
Début pressurisation

Reached 450m
Arrivée à 450m

Diver 1 locked out
Plongeur 1 à l'eau

Diver 1 returned
Retour du plongeur 1

Diver 2 locked out
Plongeur 2 à l'eau

Diver 2 returned
Retour du plongeur 2

Start pressurization
Début pressurisation

Reached 460 m
Arrivée à 460 m

Start decompression
Début décompression

Reached 430 m
Arrivée à 430 m

Time in minutes / Temps en minutes

360

300

240

180

120

60

Time in minutes / Temps en minutes

DIVE 4 Plongée 4

BELL'S ENVIRONMENTAL PARAMETERS

- · — · — · : Pp CO₂ : Carbon dioxide partial pressure
- - - - - : Pp O₂ : Oxygen partial pressure
- — — — — : Depth

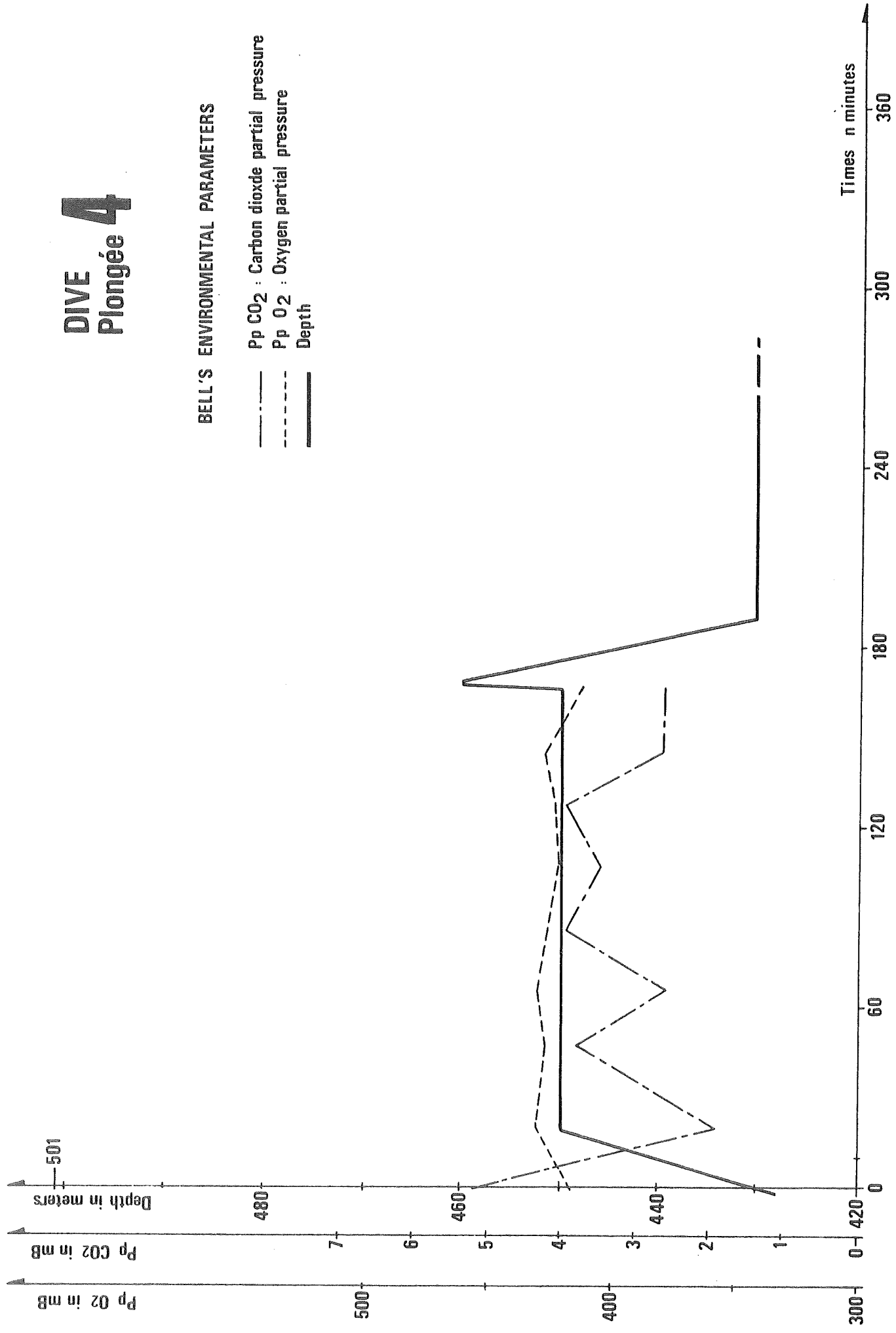

D I V E V

JANUS IV

DIVING REPORT / RAPPORT DE PLONGÉE

DIVE N° V
Plongée

DATE : 20 OCTOBRE 1977

DIVING SUPERVISOR : CROZIER Jacques
Chef de plongée

DIVER 1 } VERPEAUX Jacques
Plongeur 1 }

DIVER 2 } VIAL Gérard
Plongeur 2 }

BELL-MAN : RAUDE Patrick

	TIME / Temps	DEPTH / Profondeur
START OF COMPRESSION <i>Début compression</i>	13 H 35	430 m
END OF COMPRESSION <i>Fin compression</i>	15 H 05	489 m
START OF DECOMPRESSION <i>Début décompression</i>	16 H 24	501 m
END OF DECOMPRESSION <i>Fin décompression</i>	17 H 25	430 m

DURATION OF THE DIVE TEMPS DE PLONGÉE	
	2 H 49

DIVER 1 / PLONGEUR 1

TIME / Temps	15H20	15H25	15H29	15H32								
WATER / Eau	43	43	43	43								
BREATHING RATE OF DIVER / PER MINUTE <i>Rythme respiratoire Plongeur / minute</i>	15	22	24	24								

WORK PERFORMED / Travail effectué
 THE DIVER INSCRIBES HIS NAME, CHRISTIAN NAME,
 DATE AND DEPTH ON A PLASTIC PLAQUE.
 INSCRIPTIONS SUR UNE PLAQUETTE EN PLASTIQUE DE LA
 DATE, DU NOM ET DU PRENOM DU PLONGEUR ET DE LA
 PROFONDEUR.

	BEGINNING	END
WATER TEMPERATURE <i>Température de l'eau</i>	13°2 C	
	<i>Début</i>	<i>Fin</i>

TIME SPENT IN WATER <i>Temps total dans l'eau</i>	0 H 10
--	--------

DIVER 2 / PLONGEUR 2

TIME / Temps	15H55											
WATER / Eau	43											
BREATHING RATE OF DIVER / PER MINUTE <i>Rythme respiratoire Plongeur / minute</i>	14											

WORK PERFORMED / Travail effectué
 GENERAL EXCURSION:
 EVOLUTION DANS L'EAU.

	BEGINNING	END
WATER TEMPERATURE <i>Température de l'eau</i>	13° 2 C	
	<i>Début</i>	<i>Fin</i>

TIME SPENT IN WATER <i>Temps total dans l'eau</i>	0 H 10
--	--------

Depth in metres
Profondeur en mètres

501

490

470

450

430

10

0

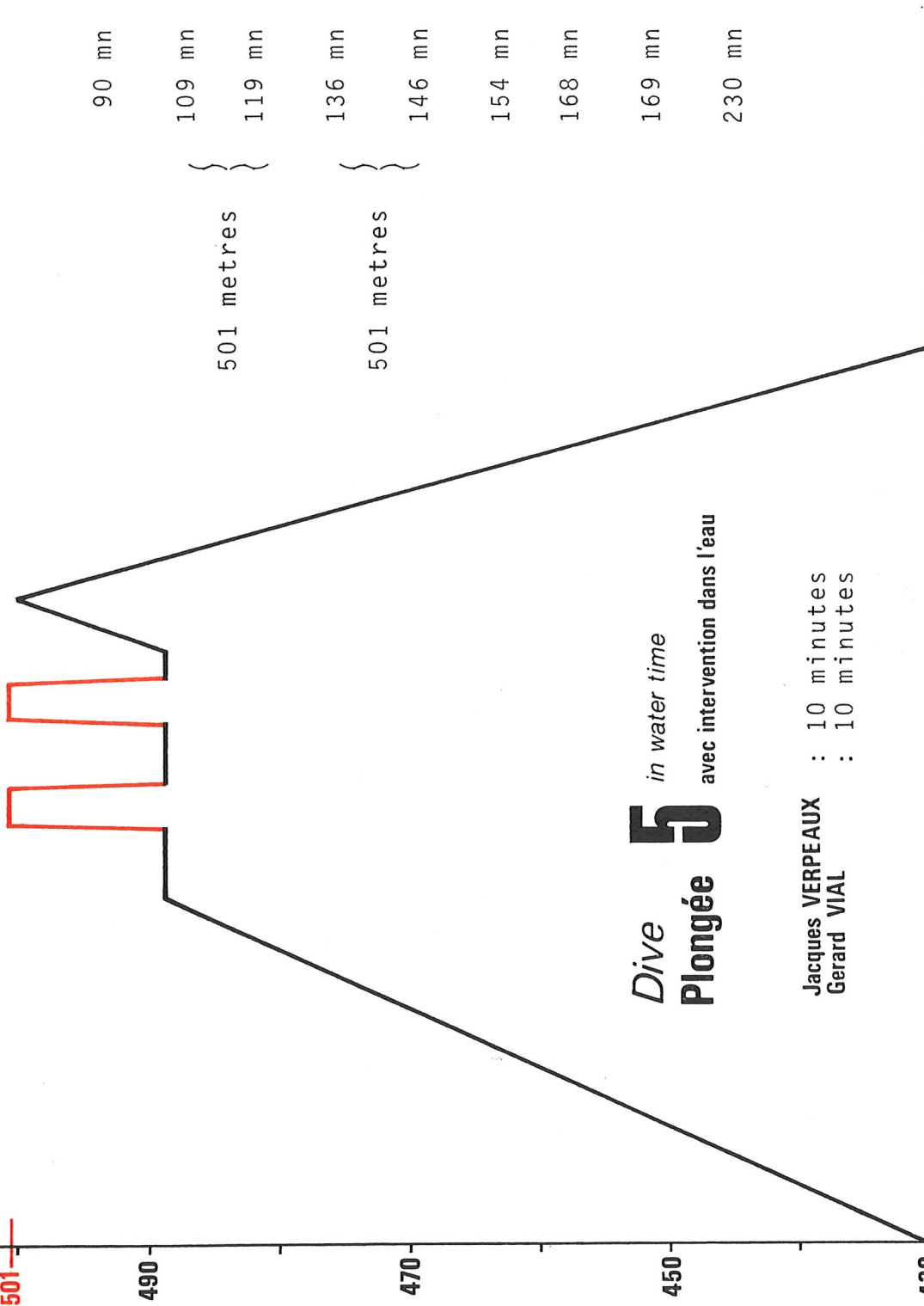

Dive 5 in water time
Plongée 5 avec intervention dans l'eau

Jacques VERPEAUX : 10 minutes
Gerard VIAL : 10 minutes

Time elapsed Temps

Real time Horaire

Start pressurization
Début pressurisation

13h.35

Reached 489m
Arrivée à 489 m

15h.05

90 mn

Diver 1 locked out
Plongeur 1 à l'eau

15h.24

109 mn

501 metres

Diver 1 returned
Retour du plongeur 1

15h.34

119 mn

Diver 2 locked out
Plongeur 2 à l'eau

15h.51

136 mn

501 metres

Diver 2 returned
Retour du plongeur 2

16h.01

146 mn

Start pressurization
Début pressurisation

16h.09

154 mn

Reached 500m
Arrivée à 500 m

16h.23

168 mn

Start decompression
Début décompression

16h.24

169 mn

Reached 430m
Arrivée à 430 m

17h.25

230 mn

Time in minutes / Temps en minutes

360

300

240

180

120

60

DIVE 5 Plongée 5

BELL'S ENVIRONMENTAL PARAMETERS

- Pp CO₂ : Carbon dioxide partial pressure
- - - Pp O₂ : Oxygen partial pressure
- Depth

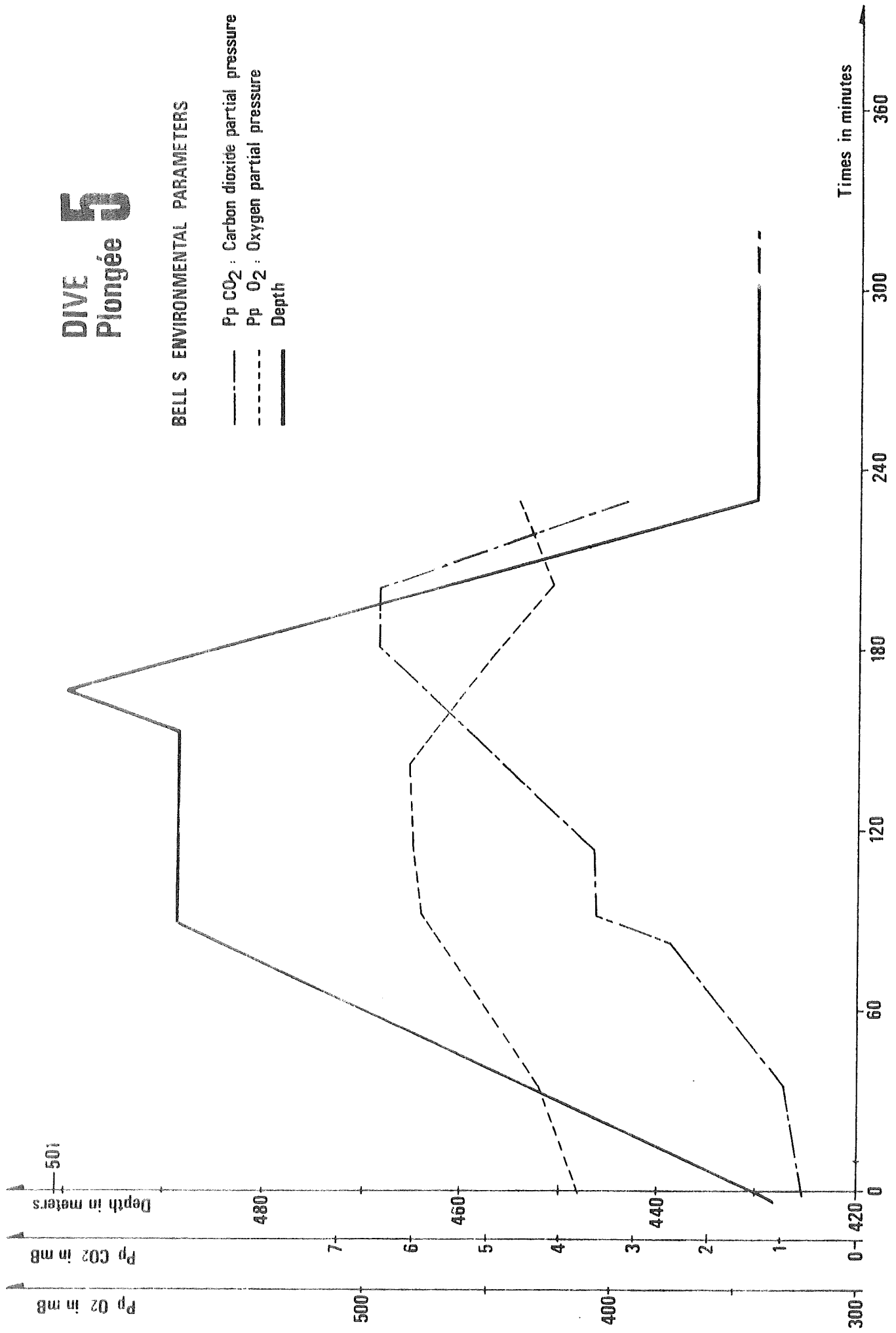

D I V E V I

DIVING REPORT / RAPPORT DE PLONGÉE

DIVE N° VI
Plongée N° VI

DATE : 20 OCTOBRE 1977

DIVING SUPERVISOR : CROZIER Jacques
Chef de plongée

DIVER 1 } JEANTOT Philippe
Plongeur 1 }

DIVER 2 } SCHNEIDER Louis
Plongeur 2 }

BELL-MAN : RAUDE Patrick

	TIME / Temps	DEPTH / Profondeur
START OF COMPRESSION <i>Début compression</i>	19 H 14	430 m
END OF COMPRESSION <i>Fin compression</i>	19 H 34	450 m
START OF DECOMPRESSION <i>Début décompression</i>	23 H 18	460 m
END OF DECOMPRESSION <i>Fin décompression</i>	00 H 13	430 m

DURATION OF THE DIVE
TEMPS DE PLONGÉE

4 H 04

DIVER 1 / PLONGEUR 1

TIME / Temps	19H55	20H10	20H20	20H35	20H50	20H55	21H05	21H22				
WATER / Eau	42	42	42	42	42	42	42	42				
BREATHING RATE OF DIVER / PER MINUTE <i>Rythme respiratoire Plongeur / minute</i>	12	14	18	15	13	20	16	16				

WORK PERFORMED / Travail effectué
ON THE PIPE LOCATION OF COMECTOR USING LIFTING BAGS. CONNECTION OF THE TWO ENDS OF THE PIPE WITH THE "COMECTOR" SET.
MISE EN PLACE DU COMECTOR A L'AIDE DE PARACHUTES SUR LE PIPE. CONNEXION DES DEUX BOUTS DE PIPE AVEC LE "COMECTOR" TERMINEE.

	BEGINNING	END
WATER TEMPERATURE <i>Température de l'eau</i>	13°2 C	
	<i>Début</i>	<i>Fin</i>

TIME SPENT IN WATER
Temps total dans l'eau

1 H 49

DIVER 2 / PLONGEUR 2

TIME / Temps	21H47	21H57	22H11	22H23	22H35	23H20	23H16					
WATER / Eau	42	42	42	42	42	42	42					
BREATHING RATE OF DIVER / PER MINUTE <i>Rythme respiratoire Plongeur / minute</i>	15	12	14	14	12	14	16					

WORK PERFORMED / Travail effectué
TIGHTENING OF THE "COMECTOR".
SERRAGE DU "COMECTOR".

	BEGINNING	END
WATER TEMPERATURE <i>Température de l'eau</i>	13°2 C	
	<i>Début</i>	<i>Fin</i>

TIME SPENT IN WATER
Temps total dans l'eau

1 H 30

Depth in metres
Profondeur en mètres

501

Dive 6 Plongée 6

in water time
avec intervention dans l'eau

Philippe JEANTOT : 01h.49
Louis SCHNEIDER : 01h.30

Time elapsed
Temps

Real time
Horaire

Start pressurization
Début pressurisation

19h.14

Reached 450m
Arrivée à 450m

20 mn

Diver 1 locked out
Plongeur 1 à l'eau

34 mn

Diver 1 returned
Retour du plongeur 1

143 mn

Diver 2 locked out
Plongeur 2 à l'eau

153 mn

Diver 2 returned
Retour du plongeur 2

243 mn

Start pressurization
Début pressurisation

244 mn

Reached 460 m
Arrivée à 460 m

244 mn

Start decompression
Début décompression

244 mn

Reached 430 m
Arrivée à 430 m

299 mn

Time in minutes / Temps en minutes

0

60

120

180

240

300

360

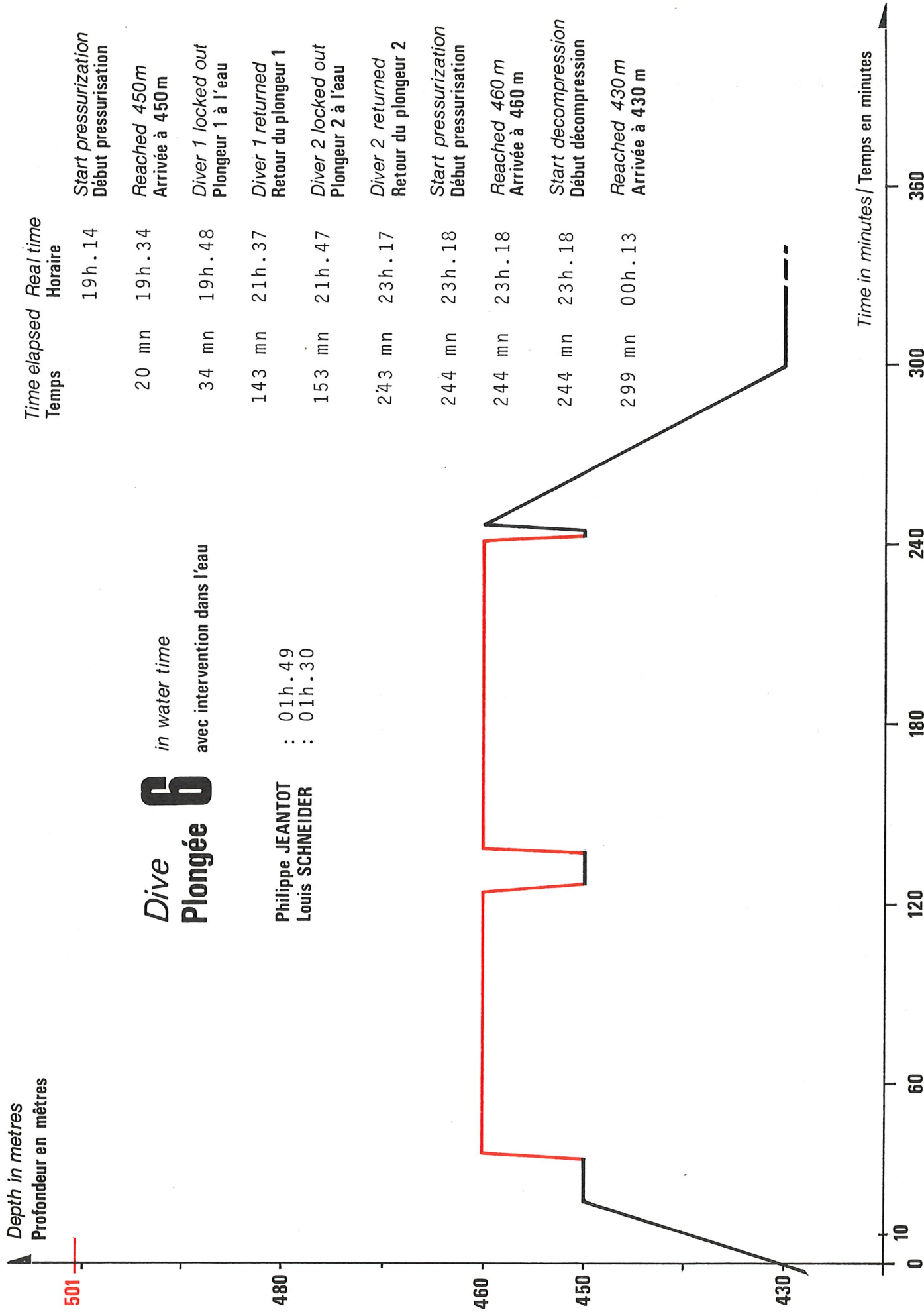

DIVE 6

Plongée 6

BELL'S ENVIRONMENTAL PARAMETERS

- Pp CO₂ : Carbon dioxide partial pressure
- - - Pp O₂ : Oxygen partial pressure
- Depth

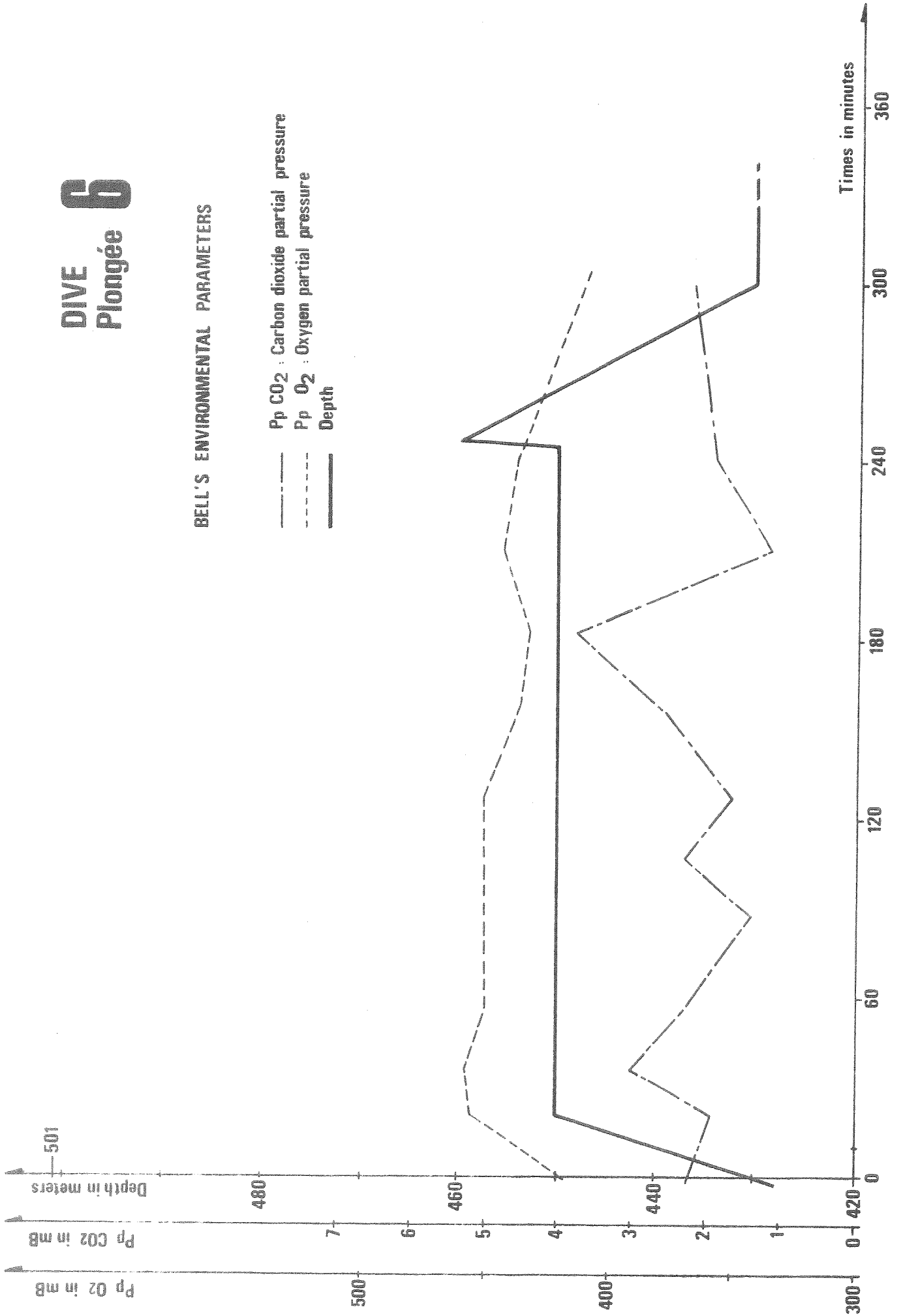

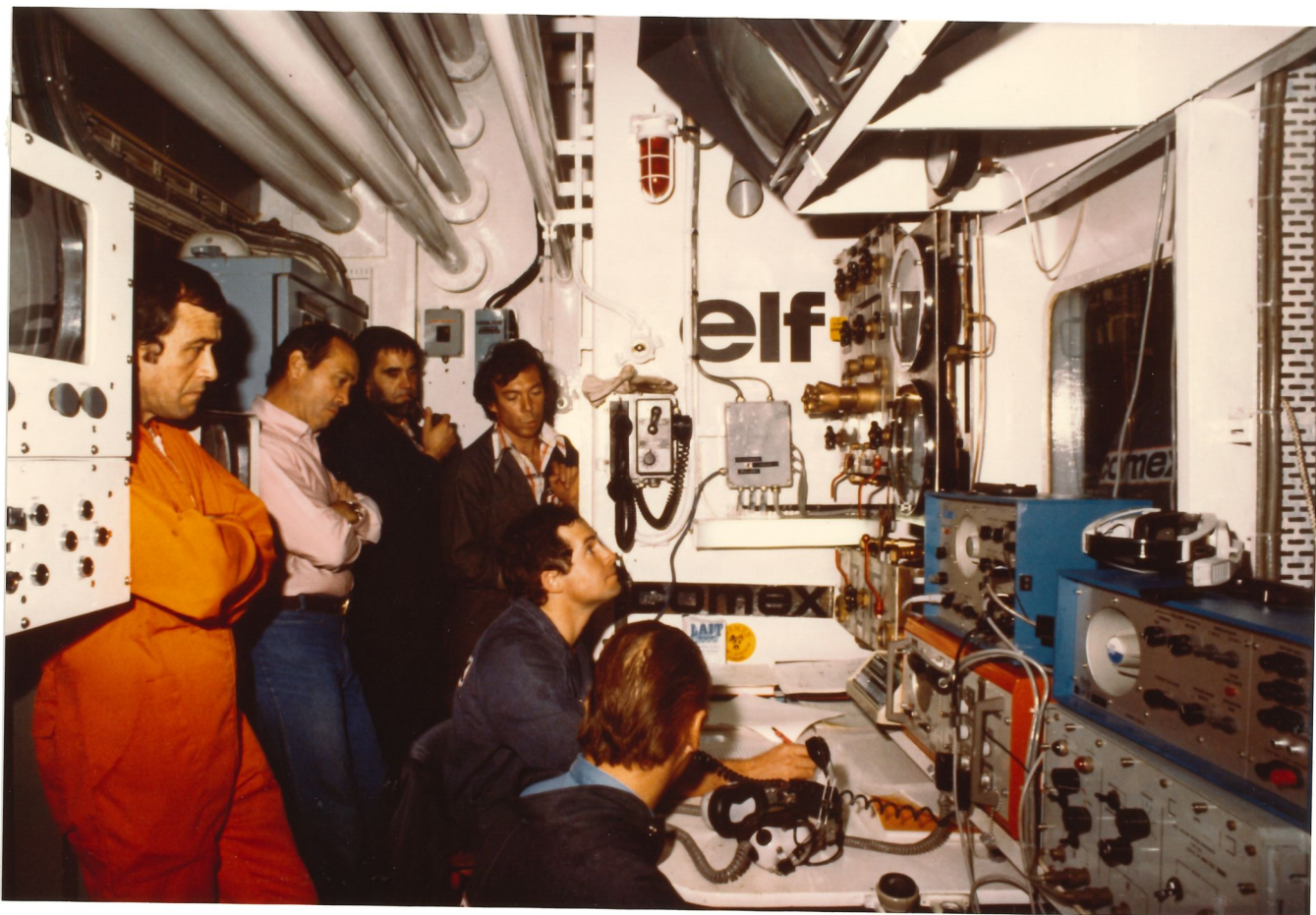

SURFACE TEAM SUPERVISING A DIVE FROM THE DIVE CONTROL STATION

II - CHECK LIST BELL INTERIOR

A - HELLE COMMUNICATIONS TESTS

- . Bell general
- . Diver N° 1
- . Diver N° 2
- . Bellman

B - FUNCTIONAL TESTS AND PREPARATION

- . Change soda lime in CO₂ scrubber
- . Fill spare bail out bottle
- . Test CO₂ scrubber fan N° 1
- . Test CO₂ scrubber fan N° 2
- . Test heater fan
- . Try inside lights
- . Try outside lights
- . Open hot water inlet valve
- . Open hot water outlet valve
- . Close all diver hot water supply valves.
- . Open pressurization by umbilical valve
- . Open respiration by umbilical valve.
- . Check pressure gauge reading (80 bars)
- . Set pressure reducers to 10 bars
- . Open valves downstream from pressure reducer (gauge)
- . Check feed line to masks and test masks
- . Test the three BIBS.

C - SHUTTLE VALVE TEST

- . Close respiration by umbilical

- . Check reading on pressure gauge downstream from shuttled valve (should be 80 bars).
- . Open bell cylinder supply and check pressure (200 bars).
- . Bleed off umbilical supply circuit by means of the purge valve.
- . Check operation of shuttle valve.
- . Take reading on pressure gauge downstream from shuttle valve (200 bars)
- . Open umbilical respiration supply
- . Purge masks slowly
- . Check to see that the shuttle valve returns to its original position and that the pressure gauge downstream from the valve again reads 80 bars.
- . Turn off supply to masks
- . Purge

D - BELLMAN BREATHING CIRCUIT CHECK LIST

- . Open bellman's respiration circuit.
- . Check pressure gauge reading. It should be 200 bars.
- . Open valve upstream from pressure reducer
- . Set pressure reducer to 10 bars
- . Open valve downstream from pressure reducer.
- . Test mask
- . Turn off supply to mask and purge.
- . Close bell pressurization valve on umbilical respiration line.
- . Close bell pressurization valve on bell gas supply line.
- . Open valve on bell internal pressure measuring line.

- . Close pneumo gauge diver 2
- . Close pneumo gauge diver 1
- . Open valve bell supply respiration
- . Close slow bleed off decompression valve.
- . Open emergency bell-ventilation valve.
- . Close upper and lower valves on 1" goose-neck
- . Test bell pressurization by umbilical
- . Test bell pressurization by umbilical respiration line.
- . Test bell pressurization by bell respiration line.

E - OXYGEN MAKE-UP SYSTEM

- . Check to see that the O₂ cylinder has been filled
- . Open interior manifold supply valve.
- . Open buffer bottle manifold valve.
- . Open interior buffer bottle supply valve.
- . Check to see that differential pressure gauge reads 5 bars.
- . Close buffer bottle manifold valve.
- . Close interior manifold supply valve.
- . Keep interior pilotage valve open at all times

F - HYDRAULIC SYSTEM

- . Check accumulator pressure
- . Close all hydraulic valves.

G - TOOLS AND SUPPLIES : CHECK LIST

- . "MASDAM " rope puller
- . Hammer

- . Monkey wrench
- . Hack saw
- . Screw driver
- . Pliers
- . Scotch tape - teflon tape - rag
- . Two flashlights in good working order
- . One colorimetric pump and sampling tubes.
- . Three nose clips and one mouth-opener
- . Spare soda lime supply
- . Drinking water supply
- . Extra O-ring for bottom hatch door.
- . Two breast weights and one weight belt.
- . 3 pairs of fins, 3 knives, 1 extra diving helmet, 3 safety harnesses, 4 spiders
- . First aid kit.

III - CHECK LIST BELL EXTERIOR

- | | |
|--|--------|
| . Fill reserve cylinders to 200 bars | |
| . Fill O ₂ cylinder to 160 bars | |
| . Cylinder valves outside bell | OPEN |
| . Check spotlights | |
| . 1" decompression valve | OPEN |
| . Hot water intake valve | OPEN |
| . Hot water outlet valve to divers | OPEN |
| . O ₂ pressure reducer pilotage valve | OPEN |
| . Valve for pressurization by umbilical | OPEN |
| . O ₂ make-up supply valve | OPEN |
| . Hot water outlet valve "Kinergetics" | OPEN |
| . Slow bleed-off valve (1/4 turn) | OPEN |
| . Emergency bell-ventilation needle valve | CLOSED |
| . O ₂ buffer bottle supply valve | OPEN |
| . Emergency cylinder delivery valves | OPEN |
| . Bellman respiration delivery valve | OPEN |
| . Bellman's pressure gauge valve | OPEN |
| . Bell interior pressure-measuring valve
(1) bell-surface | OPEN |
| . Bell interior pressure-measuring valve
(2) bell-surface | OPEN |
| . Pneumo gauge valve diver 1 | CLOSED |
| . Pneumo gauge valve diver 2 | CLOSED |
| . Gas analysis valve | OPEN |
| . Respiration by umbilical valve | OPEN |

IV - EMERGENCY PROCEDURES

A - COMPLETE BREAKDOWN IN COMMUNICATIONS

- . Surface notifies bellman of communications failure by turning bell lights off and on three times.
- . Bellman recalls diver to bell
- . Inside hatch door is closed
- . Bell signals O.K. to surface via T.V. If there is no TV the standby submersible (if any) signals O.K. to surface.
- . Surface seals door by remote control and pressurizes bell to 460 meters.

B - ELECTRICAL FAILURE

1) In the bell

- . Use flashlights
- . Bring divers back to bell

2) Of the winch

- . Raise bell by emergency air winch (5-6 hours).

C - ELECTRO-MECHANICAL CABLE FAILURE

- 1) Jettison cable socket
- 2) Bell regains surface by guide lines.

D - UMBILICAL FAILURE

- 1) Close skin valve for pressurization by umbilical
- 2) Close hot water inlet valve

- 3) Close interior pressure-sampling valve N° 1
- 4) Close interior pressure-sampling valve N° 2
- 5) Close analysis valve.

Close these valves in the order indicated.

E - SODA LIME SCRUBBER FAN FAILURE

Switch over to either :

- . emergency respiration (1st choice) or
 - . B.I.B.S. (2nd choice).
-

P H A S E I I I

DECOMPRESSION PHASE

- DECOMPRESSION PHASE

I - Decompression started October 22nd at 00:04 a.m., 24 hours after completion of the diving phase, and followed the general profile shown on page 148.

The environmental parameters were systematically analyzed and recorded during decompression. See chart on page 149.

Bubbles circulating in the divers' blood streams were checked regularly throughout decompression.

II - METHOD OF DETECTING CIRCULATING BUBBLES

To detect moving bubbles an ultrasonic Doppler-effect type of device was used which had been developed by the I.N.S.A. in Lyon and tested experimentally on both animals and human beings by the C.E.R.T.S.M. in Toulon.

This is a portable apparatus which can be used in a pressurized chamber. The sound signals are amplified and tape-recorded.

The subcutaneous sensing element is placed in the precordium. The bubbles are detected in the heart and the pulmonary artery before they reach the lungs. The occurrence of bubbles is classified according to the Spencer scale :

STAGE 0 : total absence of bubbles

STAGE 1 : an occasional isolated bubble but the majority of systoles have none.

STAGE 2 : several systoles, but less than half, contain bubbles either singly or in groups.

STAGE 3 : nearly all or all of the systoles contain bubbles singly or in groups, but the heart beat is still audible.

STAGE 4 : the signals from bubbles at each systole cover up the normal physiological signals.

Only a trained operator can differentiate between the bubble stages, but such a person can be trained rapidly with the aid of the teaching cassette which comes with the detector.

The recording is made with the subject at rest and in movement (3 bends 10 seconds apart). The bubble stages in movement are always higher than those at rest, as the bubbles accumulate in the muscular masses and are set in motion by exercise. When stage 3 is recorded with the subject at rest, he is not made to exercise any more.

The tables on the following pages show the bubble stages detected during decompression.

DETECTION OF CIRCULATING BUBBLES FOLLOWING EXCURSION DIVES

DIVER	18 / 10 / 77			19 / 10 / 77			20 / 10 / 77			21 / 10 / 77								
	Return from 460 M dive			Return from 460 M dive			Return from 500 M dive			1h after return from 500 M dive			Sojourn at 430 meters					
	R	M	H	R	M	H	R	M	H	R	M	H	R	M	H	R	M	H
RAUDE	0	0	60	0	0	80	1	2	90	2	3	70	0	0	80	0	0	70
VERPEAUX	0	0	76	0	0	84	0	0	96	0	2	80	0	0	80	0	0	70
VIAL	0	0	80	0	0	84	0	0	84	0	1	90	0	0	90	0	0	90
	460 M			460 M			460 M			430 M								
	R	M	H	R	M	H	R	M	H	R	M	H	R	M	H	R	M	H
JEANTOT	0	0	76	0	0	72	0	0	0	0	80	0	0	0	70	0	0	70
SCHNEIDER	0	0	96	0	0	80	0	0	0	90	0	0	0	0	80	0	0	80
SEVELLEC	0	0	100	0	0	90	0	0	0	80	0	0	0	0	90	0	0	80

* R = Rest - M = Movement - H = Heartbeat

DETECTION OF CIRCULATING BUBBLES DURING DECOMPRESSION (1)

DIVER	TIME	22 / 10 / 77			23 / 10 / 77			24 / 10 / 77			25 / 10 / 77						
		.meters	R	M	H	.meters	R	M	H	.meters	R	M	H				
RAUDE	9 H	375	1	2	70	295	0	3 ⁻	70	235	0	2	80	180	1	2	80
	15 H	353	0	1 ⁺	70	278	1	2	64	223	1 ⁺	2	60	167	0	2	80
	21 H	333	1	1 ⁺	70	264	1	3	70	207	1	1	80	156	0	2	80
VERPEAUX	9 H	375	0	2	60	295	0	2 ⁺	80	235	0	0	64	180	0	0	70
	15 H	353	0	2	60	278	0	2	64	223	0	1	60	167	0	1	70
	21 H	333	0	3 ⁻	60	264	1	2	64	208	0	2	60	156	0	2	68
VIAL	9 H	374	0	1	90	295	1	3 ⁺	84	235	1	3	80	180	1	2	80
	15 H	353	1 ⁻	3	100	278	2	3	90	223	1	3	70	167	0	2	84
	21 H	333	1	3 ⁺	90	264	2	3 ⁺	80	208	1	4	80	156	2	3	80
JEANTOT	9 H	374	0	0	70	294	0	0	60	235	0	1	80	180	0	0	76
	15 H	352	0	0	60	278	0	0	64	222	0	2	80	167	0	2	76
	21 H	333	0	0	70	264	/	/	/	208	0	0	80	156	0	2	80
SCHNEIDER	9 H	374	0	0 ⁺	75	295	1	3	72	235	1	3	80	180	1	3	80
	15 H	352	0	2	70	278	0	2	70	222	1	3	80	168	0	2	76
	21 H	333	0	3	70	264	1	2 ⁺	64	208	1	3	70	156	1 ⁺	2 ⁺	72
SEVELLEC	9 H	374	0	0	86	294	0	0	84	235	0	0	90	180	0	1 ⁻	84
	15 H	351	0	0	90	278	0	2	90	223	0	2	90	167	0	2	84
	21 H	333	0	2	90	264	0	2	84	208	0	2	80	156	0	2 ⁺	80

DETECTION OF CIRCULATING BUBBLES DURING DECOMPRESSION

(2)

DIVER	TIME	26 / 10 / 77			27 / 10 / 77			28 / 10 / 77			29 / 10 / 77					
		meters	R	M	H	meters	R	M	H	meters	R	M	M			
RAUDE	9 h	134	1	2	88	87	1	2	80	48	0	2	84	8	0	0
	15 h	124	1	3	80	77	2	3	72	38	0	2	90	4	0	0
	21 h	113	2	2	/	67	0	2	84	28	1	2	80	/	/	/
VERPEAUX	9 h	134	1	2	80	87	0	2	70	48	0	2	64	10	0	0
	15 h	124	1	1	80	77	2	2	68	38	1	2	88	4	0	0
	21 h	113	0	2	/	67	0	2	84	28	1	2	95	/	/	/
VIAL	9 h	134	1	3	76	87	1	2	70	48	0	3	64	8	1	3
	15 h	124	1	3	72	77	1	3	80	38	0	3	64	4	1	2
	21 h	113	1	3	/	67	2	3	84	28	2	3	80	/	/	/
JEANTOT	9 h	134	0	2	64	87	0	2	70	48	1	3	60	10	/	2
	15 h	124	0	0	68	77	2	3	80	38	1	3	80	4	0	1
	21 h	113	0	3	/	67	0	3	80	28	2	3	100	/	/	/
SCHNEIDER	9 h	134	1 ⁺	3	80	87	1	3	80	48	2	3	84	8	0	2
	15 h	124	/	3	72	77	2	2	80	38	2	3	84	4	0	NM
	21 h	113	2	3	/	67	0	2	76	28	asleep	2	asleep	/	/	/
SEVELLEC	9 h	134	0	3	88	87	- 0	1	98	48	0	2	84	8	0	2
	15 h	124	0	2	80	77	0	3	84	38	1	3	90	4	0	1
	21 h	113	0	2	/	67	1	3	88	28	1	3	90	28	1	3

DECOMPRESSION

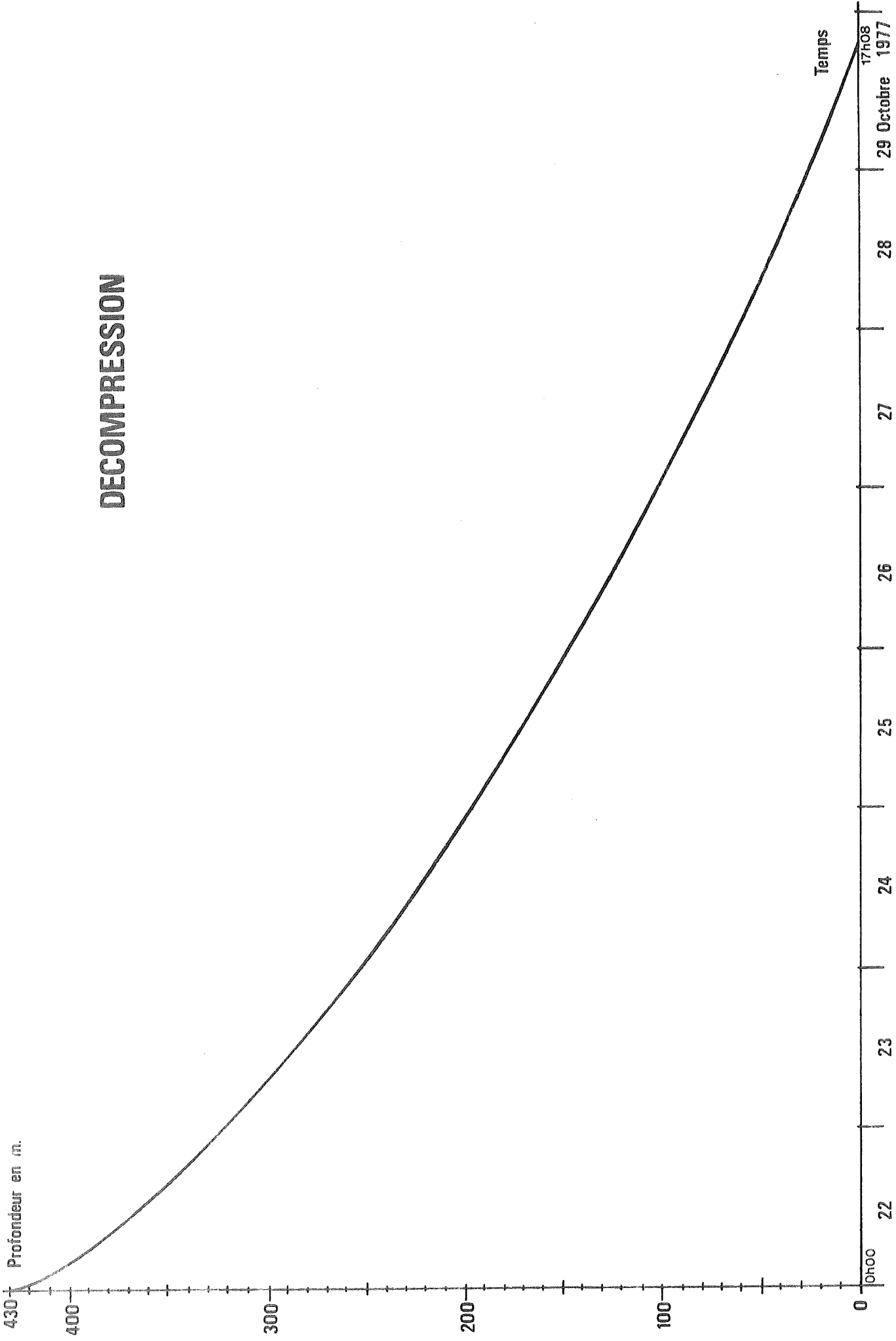

DECOMPRESSION

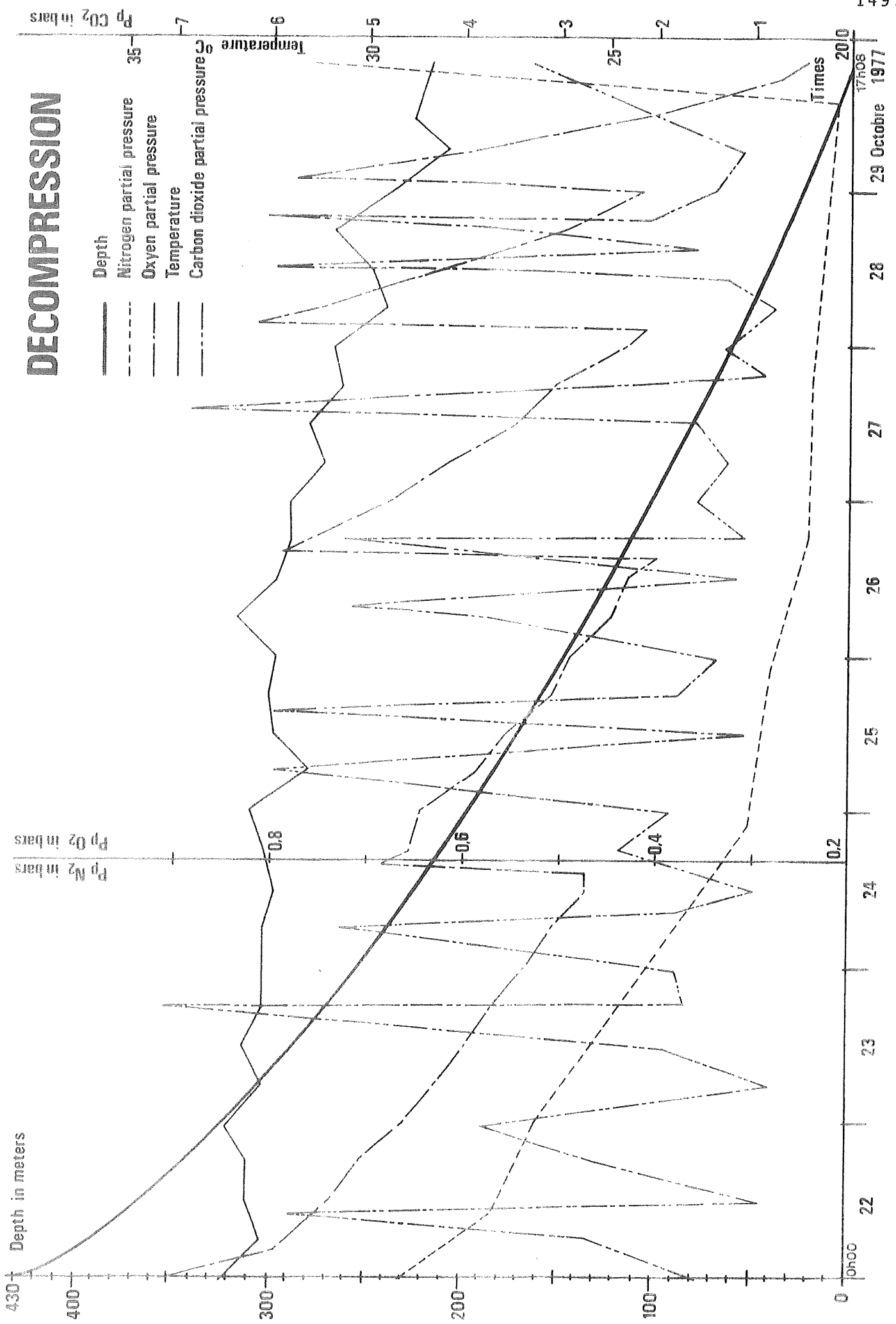

PHASE III

RESUME

JANUS IV

- RESUME

I - SUMMARY OF DIVES

During the six dives which took place between October 18th at 10:42 a.m. and October 21th at 00:15 a.m. ten hours of work were accomplished on the 460-meter deep worksite and two divers effected dives at 501 meters for ten minutes each.

The tables on the next three pages show :

- an overall analysis of the dives
- in-water time per dive, by diver
- analysis of total diving time, by diver.

BREAKDOWN OF IN-WATER TIME PER DIVE, BY DIVER

DIVERS' NAME	DIVE N° 1 October 18, 1977 460 m	DIVE N° 2 October 18, 1977 460 m	DIVE N° 3 October 19, 1977 460 m	DIVE N° 4 October 19, 1977 460 m	DIVE N° 5 October 20, 1977 460 m	DIVE N° 6 October 20, 1977 460 m	TOTAL
JEANTOT Philippe				00H. 35		01H. 49	02H. 24
RAUDE Patrick			02H. 21				02H. 21
SCHNEIDER Louis		00H. 45				01H. 30	02H. 15
SEVELLEC Emile		00H. 17		00H. 55			01H. 12
VERPEAUX Jacques	00H. 35				00H. 10		00H. 45
VIAL Gérard	00H. 13		01H. 00		00H. 10		01H. 23

OVERALL ANALYSIS OF THE DIVES

	DIVERS' NAME	DEPTH IN WATER	TOTAL DIVE TIME	DECOMPRESSION TIME	BELL BOTTOM TIME	TOTAL IN-WATER TIME	IN-WATER TIME BREAKDOWN	PERCENTAGE OF IN-WATER TIME FOR BOTTOM TIME
DIVE 1	VERPEAUX J. VIAL G.	460	03H. 22	00H. 16	02H. 35	00H. 48	00H. 35 00H. 13	30
DIVE 2	SCHNEIDER L. SEVELLEC E.	460	02H. 46	00H. 16	02H. 10	01H. 02	00H. 45 00H. 17	48
DIVE 3	RAUDE P. VIAL G.	460	06H. 32	00H. 24	04H. 48	03H. 21	02H. 21 01H. 00	70
DIVE 4	JEANTOT P. SEVELLEC E.	460	03H. 07	00H. 17	02H. 30	01H. 30	00H. 35 00H. 55	60
DIVE 5	VERPEAUX J. VIAL G.	501	03H. 50	01H. 01	01H. 19	00H. 20	00H. 10 00H. 10	15
DIVE 6	JEANTOT P. SCHNEIDER L.	460	04H. 59	00H. 57	03H. 44	03H. 19	01H. 49 01H. 30	89
TOTAL AT 460 meters					15H. 47	10H. 00		65

ANALYSIS OF TOTAL DIVING TIME, PER DIVER

DIVERS' NAME	TOTAL IN - WATER TIME	TOTAL EXCURSION DIVE TIME	BREAKDOWN FOR			TOTAL BOTTOM TIME	PERCENTAGE OF IN-WATER TIME FOR BOTTOM TIME
			OCTOBER 18, 1977		OCTOBER 20, 1977		
			OCTOBER 18, 1977	OCTOBER 19, 1977			
JEANTOT Philippe	02H. 24	10H. 52	02H. 46	03H. 07	04H. 59	08H. 24	30
RAUDE Patrick	02H. 21	13H. 44	03H. 22	06H. 32	03H. 50	08H. 42	30
SCHNEIDER Emile	02H. 15	10H. 52	02H. 46	03H. 07	04H. 59	08H. 24	30
SEVELLEC Emile	01H. 12	10H. 52	02H. 46	03H. 07	04H. 59	08H. 24	15
VERPEAUX Jacques	00H. 45	13H. 44	03H. 22	06H. 32	03H. 50	08H. 42	10
VIAL Gérard	01H. 23	13H. 44	03H. 22	06H. 32	03H. 50	08H. 42	15

II - SUMMARY OF GAS CONSUMPTION

Although the diving gas recovery system was employed for all six dives, fairly large quantities of gas were nevertheless consumed, as shown on the following table.

DIVE	TOTAL DIVE TIME	IN-WATER TIME	AMOUNT OF HELIOX CONSUMED
DIVE 1	187mn	48mn	80 Nm ³
DIVE 2	166mn	62mn	160 Nm ³
DIVE 3	392mn	201mn	200 Nm ³
DIVE 4	187mn	90mn	120 Nm ³
DIVE 5	230mn	20mn	180 Nm ³
DIVE 6	299mn	199mn	180 Nm ³
TOTAL HELIOX 1/99 CONSUMED :			920 Nm ³

This gas consumption was due to :

- pressurization of the bell from living depth to working depth.
- changing water level in skirt of bell to facilitate entry and exit of divers.
- pressurization fo hatch between bell and chamber when these are mated after dives.

- leaks, in the connection and couplings between the gas trailer and the divers, and particularly in the swivel connector for the umbilical.

Let us examine what this consumption of heliox represents :

Normally the ten hours and twenty minutes of in-water time would represent a consumption of 1450 Nm^3 at these depths solely for the divers' requirements. In addition compression of the bell from living depth to working depth uses 190 Nm^3 .

If we don't count the gas lost due to leakage, which is difficult to reckon, and that used to compensate variations in the water level in the bell, taking into account therefore only the diver's consumption and three full bell compressions, 1450

$$1450 \text{ Nm}^3 + (3 \times 190 \text{ Nm}^3) = 2020 \text{ Nm}^3 \text{ of heliox}$$

would have been consumed if the gas recovery system had not been used.

There was thus a minimum of 55 % saving in gas mixture.

III - PHYSIOLOGICAL REPORT

A - Vital capacity

Alveolocapillary diffusion was measured before the divers went into saturation and about 16 hours after they came out, by CO ductance method. Five of the divers showed no change. One showed a slight decrease in alveolocapillary diffusion, but it is without any significance.

B - Blood analysis

Blood analyses were made before and after Operation "JANUS IV" to determine the fibrin, lipid, cholesterol and platelet count of each diver. The results are shown on page 157.

R E S U L T S O F B L O O D A N A L Y S E S

NAME	PLATELET COUNT		FIBRIN		CHOLESTEROL		LIPIDS		TRYGLICERIDES	
	12/10/77	29/10/77	12/10/77	29/10/77	12/10/77	29/10/77	12/10/77	29/10/77	12/10/77	29/10/77
		%		%		%		%		%
JEANTOT	196.000	129.000	2.90	6.20	2.52	2.52	8.5	9.08	0.61	0.64
		-35		+113		=		+15		+4
RAUDE	203.000	112.000	2.30	3.35	2.10	2.07	8.2	8.3	1.05	0.95
		-45		+45		=		=		-10
SCHNEIDER	233.000	134.000	4.40	3.85	1.90	1.92	6.9	7.6	0.87	0.55
		-43		-10		=		+10		-37
SEVELLEC	215.000	158.000	2.20	3.83	2.18	1.91	7.5	7.3	0.61	0.52
		-27		+74		-13		-3		-15
VERPEAUX	283.000	211.000	2.80	4.25	1.46	1.50	6.2	6.3	0.91	0.50
		-26		+52		=		=		-46
VIAL	219.000	168.000	2.80	4.08	2.36	2.34	8.3	8.7	1.36	1.25
		-24		+46		=		+5		-9

FINAL PHYSIOLOGICAL EXAMINATION

The following are the results of blood tests made on November 26, 1977, about a month after the divers came out of saturation.

NAME	PLATELET COUNT	FIBRIN
VIAL	222,000	-
RAUDE	196,000	-
SEVELLEC	189,000	-
JEANTOT	205,000	2.85
SCHNEIDER	203,000	3.24
VERPEAUX	276,000	3.95

IV - UNDERSEA WORK RESULTS

Two distinct types of work were done :

A) Welding and oxyarc cutting feasibility trials

B) 8" pipeline connection with a mechanical Comector

A) OXYARC CUTTING AND WELDING TRIALS

The cutting and welding trials showed that this type of work could be done satisfactorily with the equipment deployed.

1 - Purposes of the trials

- . To determine the reliability of the underwater welding equipment pressure-equalized at 45 bars.
- . To try out the electrodes which had been modified by COMEX for in-the-wet welding.
- . To determine the operational validity of cutting and welding at a water depth of 460 meters.

2 - Welding Installation

This equipment had already been used operationally in welding habitats. It was modified for use in Operation "JANUS IV" and consisted basically of the following components :

- . Shipboard electrical supply 440 V 60 Hz 600 Amps (peak)
- . Distribution and control panel protected by Vigilhom fault detector and circuit-breaker.
- . Pressure-equalized subsea stepdown transformer 1000 V/440 V 60 Hz.

. Static welding set :

Manufacturer : ESAB
Model : LHD 630
Power : 600 Amps
Type : : Thristor rectifier
Seaworthiness: Pressure-equalized oil-
filled container

- . An electronic control container at atmospheric pressure
- . Welding cable with a cross-section of 95mm²
- . Welding electrode holder, mfgr. WETDOCKING
- . Cutting electrode holder, mfgr. CRAFTWELD
Length of cables to welding unit : 3 meters
each DINZE male/female quick couplings.

3 - Welding Trials

With this equipment our objective was to ignite the arc and to keep it lit in order to make a weld seam. For operational reasons the welds were performed in-the-wet.

An electrode with the following characteristics was developed specially for the purpose of these trials

- . Type : Rutile
- . Make : SAF GF 130
- . Qualification : A.W.S. E6013

- . Starting voltage in atmospheric pressure : 55 volts
- . Protective varnish : 3 layers of VARATHAN 90 GLOSS liquid plastic in the form of polyhydric alcohol, applied by dipping.

4 - Welding Analysis

We performed several inspections on the welds which were made, with the results indicated below.

Visual examination showed :

Good fusion of parent metal and weld metal.
 Seam without excessive overlap or undercut.
 Longitudinal irregularity
 Density : good
 Spatter : average
 Hardness survey : HV5 load

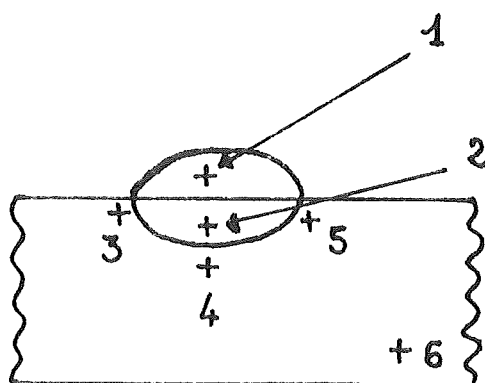

1 : 153
 2 : 209
 3 : 259
 4 : 213
 5 : 313
 6 : 187

5 - Composition of Parent Metal

The welding and cutting trials were performed on a piece of steel petroleum pipe with the following characteristics :

Diameter : 8"
Thickness : 1/2"
API Grade : 5L Grade A
Mean analysis : Maximum C 0.21
Maximum Mn 0.90
Maximum P 0.04
Maximum S 0.05

6 - Cutting Trials

For the cutting trials we used a thermic rod which was designed for low current and oxygen consumption. The electrode was manufactured by BROCO and the electrode holder by CRAFTWELD.

The BROCO electrode is a hollow rod made of rolled sheet metal the center of which is filled with steel oxyacetylene welding rods, with one aluminum rod to maintain a pilot flame by AL + O exothermal reaction.

This facilitates maintenance of the arc plasma.

The BROCO was chosen because it uses less oxygen, has a lower operating intensity and offers facility of exothermal fusion.

Oxygen was supplied from a 200 bar bank on the surface via a high flow oxygen regulator.

The pressure data is as follows :

Ambient pressure :	45 bars
Working pressure :	7 bars
Pressure loss :	3-4 bars
Pressure setting :	55 bars

The regulator was kept under a stream of hot water to prevent icing.

7 - Cut Analysis

Examination of the cut showed that the results were highly satisfactory :

It has longitudinal irregularity.

The top edge is sharply cut. The entire cut is clean, with little ferrous oxide underneath.

The average width of the cut is equal to the diameter of the electrode.

8 - Conclusions

These cutting and welding techniques can be used operationally to a depth of 460 meters. The equipment now used in pressure equilibrium on worksites at 150 meters has demonstrated its reliability at the depth of "JANUS IV".

Other trials will be necessary to determine the best equipment and the best operating conditions for this type of work, but the primary goals concerning feasibility and practicability have already been attained.

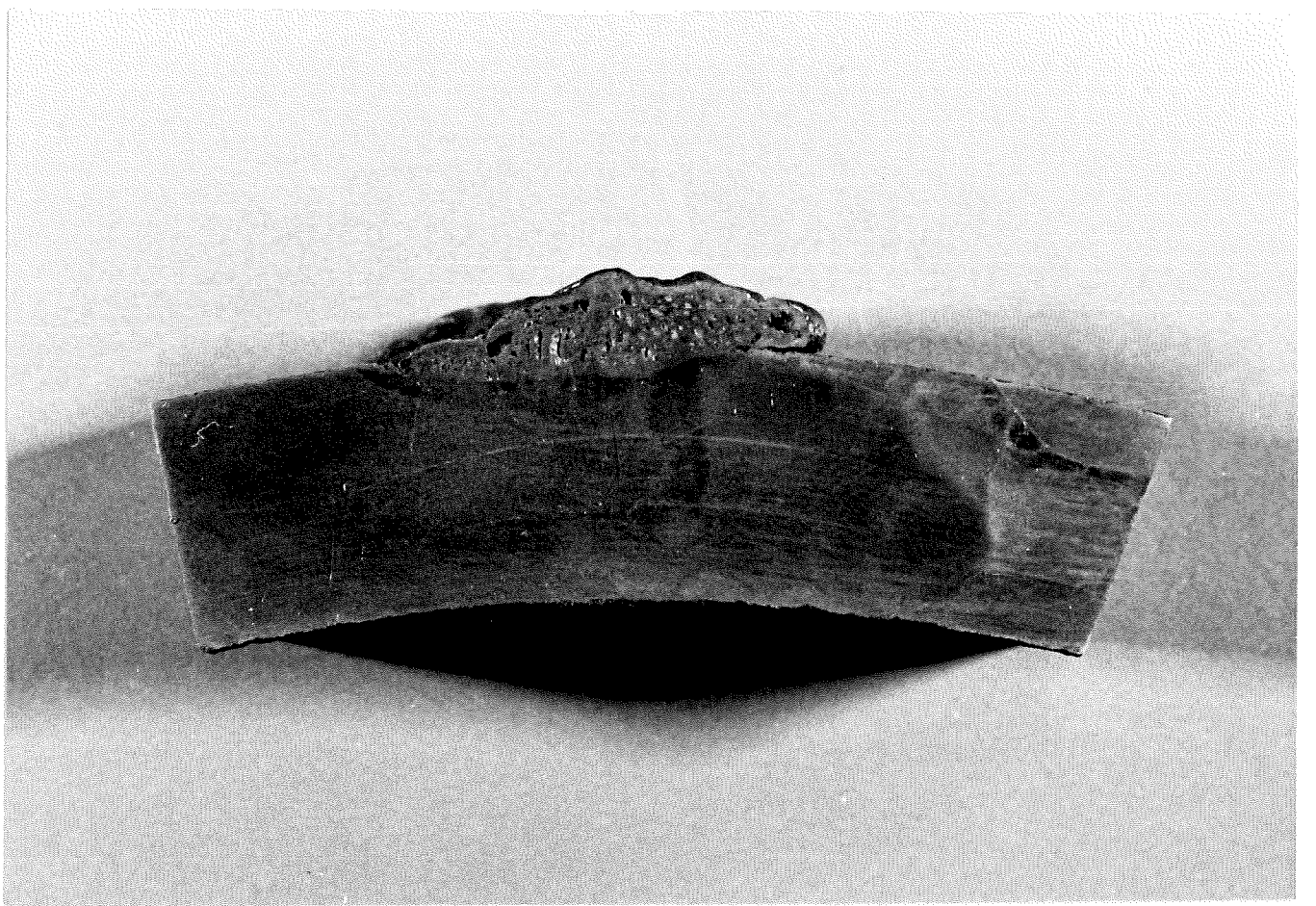

THE WELD

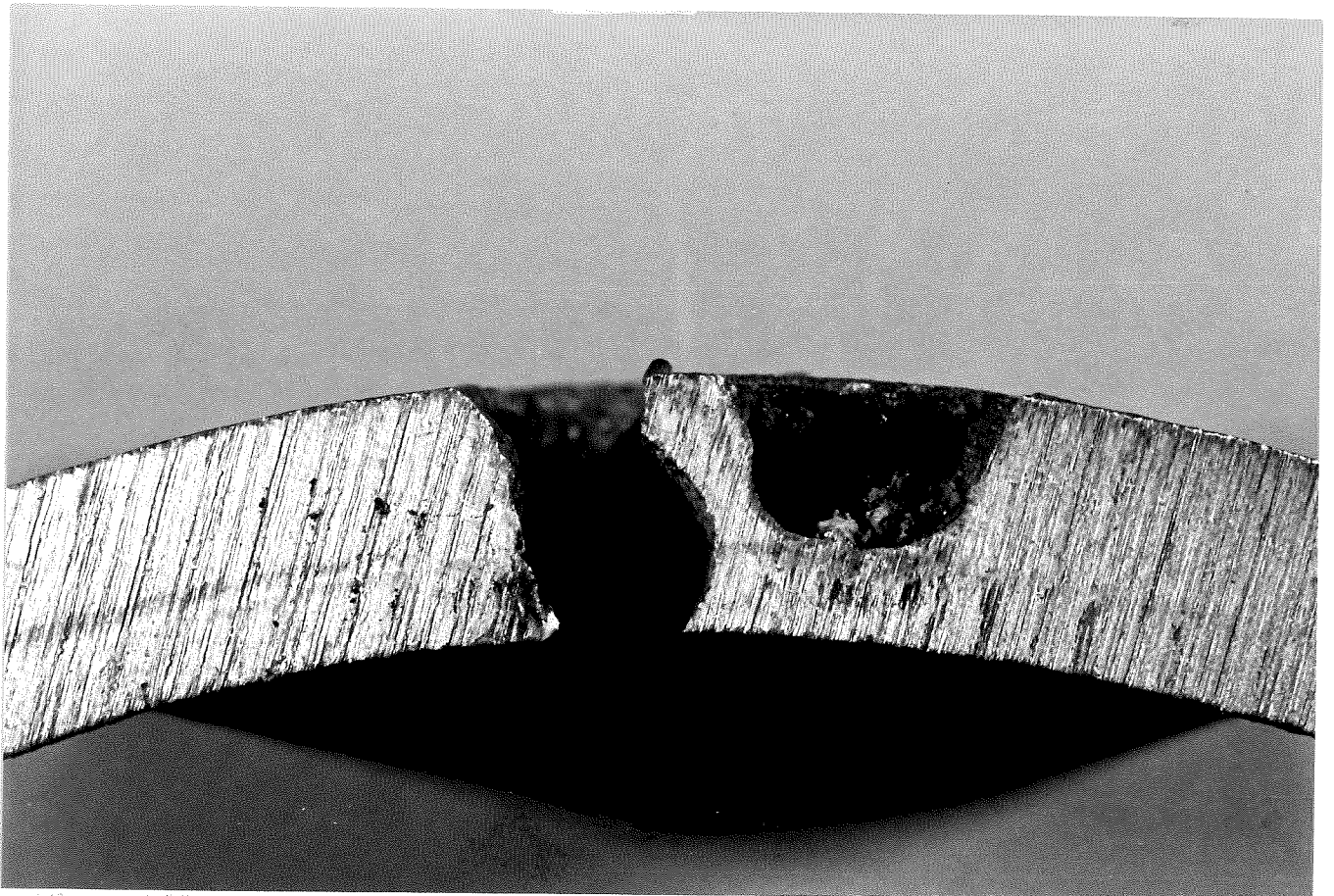

THE CUT

B) Comector Connection

Following step by step the Comector installation procedure, below is a report stating exactly what was done and what was not done, with the reasons.

STEP	EXECUTION	REMARKS
Put air bag on pipe-cutter	Done in dive 2 by Louis SCHNEIDER	
Install pipe-cutter on pipe	Done in Dive 2 by Louis SCHNEIDER	
Start up pipe-cutter	Not done in Dive 2 by Louis SCHNEIDER	Underwater hydraulic power pack failure
Remove pipe-cutter from pipe, return to its place.	Done in Dive 2 by Emile SEVELLEC	
Remove air bag from pipe-cutter, return to its place	Done in Dive 2 by Emile SEVELLEC	
Connect fill hose to Comector air bag.	Done in Dive 3 by Patrick RAUDE	
Open filling valve till Comector rises	Done in Dive 3 by Patrick RAUDE	

STEP	EXECUTION	REMARKS
Adjust air bag to desired buoyancy. Move Comector	Partly done in Dive 3 by Patrick RAUDE	Sling holding 16 ton weight under table broke ; Petrel's heave compensator could not be used. The heave prevented work being completed in this dive.
Attach lines to make air bag taut on Comector	Done during Dive 4 by Philippe JEANTOT	In spite of a heave of around one meter
Move Comector	Done during Dive 4 by Philippe JEANTOT	In spite of a heave of around one meter
Install Comector on pipe	Done during Dive 4 by Philippe JEANTOT	In spite of a heave which made the job difficult and tedious
Align mobile pipe and ball part with hydraulic jack.	Done during Dive 4 by Philippe JEANTOT	
Move Comector with Come-alongs to capture ball in housing.	Done during Dive 6 by Philippe JEANTOT	Diver exhibits complete manual and intellectual efficiency.
Remove air bag from Comector when the ball is in the housing	Done during Dive 6 by Philippe JEANTOT	
Fill Staffa motor air bag.	Done in Dive 6 by Louis SCHNEIDER	

STEP	EXECUTION	REMARKS
Bring torque motor over torque block of housing	Done in Dive 6 by Louis SCHNEIDER	Rendered difficult by the heave.
Deflate air bag so motor will stay on torque block by its own weight.	Done during Dive 6 by Louis SCHNEIDER	
Turn on torque motor by means of valve on hydraulic power pack.	Partly done in Dive 6 by Louis SCHNEIDER	Hydraulic power not working properly due to water entering electric wiring. Impossible to apply torque.
Do same for other torque blocks.	Not done	Same reason.
Return Staffa motor to its original place and attach.	Done in Dive 6 by Louis SCHNEIDER	
Coil air bag fill hose on work table.	Done in Dive 6 by Louis SCHNEIDER	
Make sure all equipment on work table is properly seized.	Done in Dive 6 by Louis SCHNEIDER	

In short, although the two 8" pipes were connected, the Comector could not be fully tightened in place due to hydraulic power failure and not from lack of time or because it was technically impossible.

The connection was made in the worst possible conditions :

- a heave on the order of one meter
- using inflatable air bags
- without any rigid base or structure on which a cross-bar could be mounted.

Under the circumstances this operation constitutes an outstanding success, demonstrating that the divers were able to work in operational conditions for the purpose of making a sealine connection identical to those commonly made in the 100-200 meter depth range.

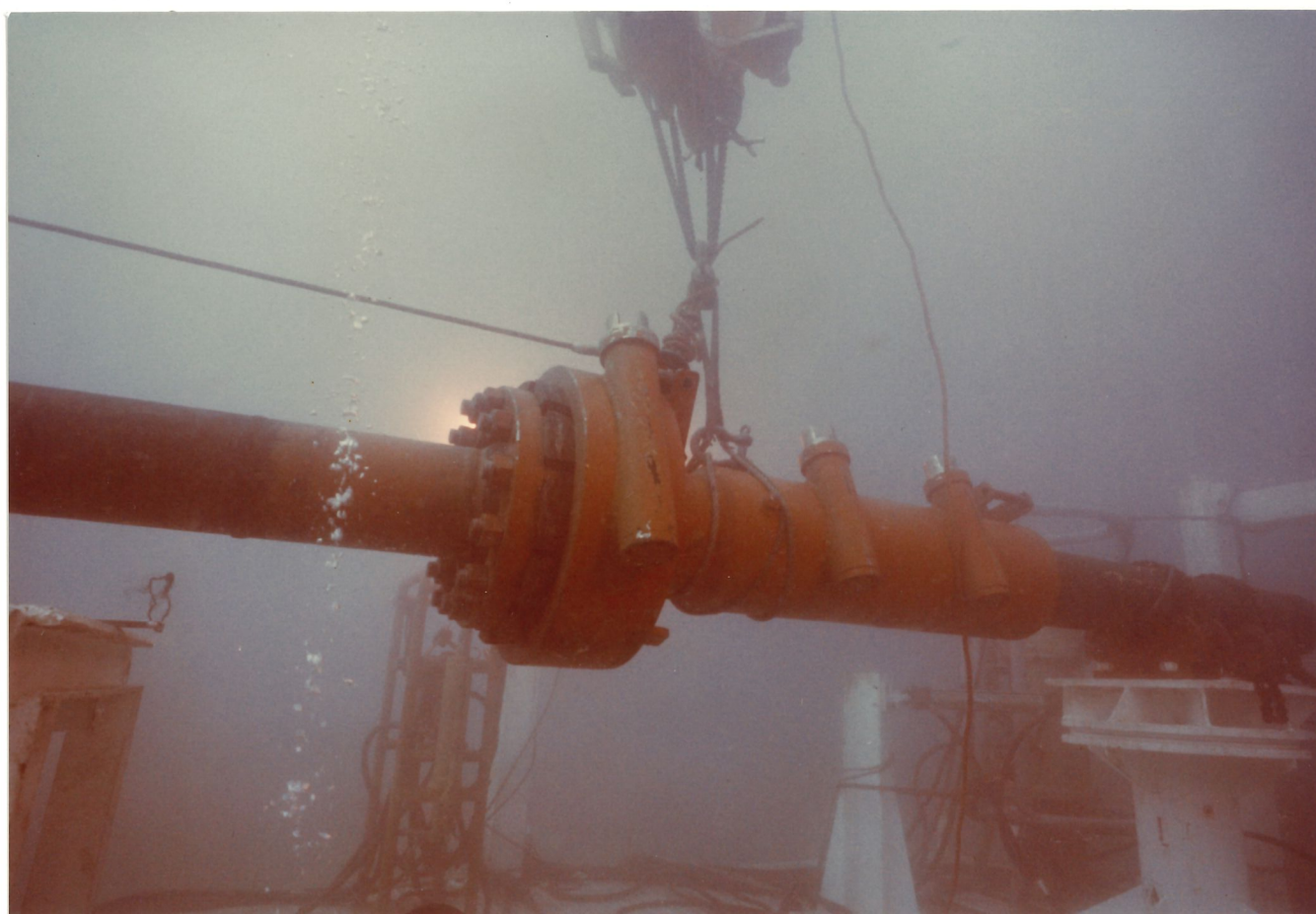

THE CONNECTION HAS BEEN MADE

C O N C L U S I O N

Operation "JANUS IV", simulating an offshore industrial worksite, took place between October 15 at 9:45 a.m. and October 29, 1977, at 5:33 p.m. off Cavalaire, France, in the Mediterranean Sea.

This operation, which was conducted by COMEX, confirmed that :

- Human intervention in 460 meters or 1510 feet of sea water is indeed possible. Six divers spent 10 hours working on a special platform installed at this depth.
- At this depth work can be performed similar to that regularly done now at 200 meters' depth, the jobs planned for the experiment having been executed in fully operational conditions. These were :
 - . Comector mechanical connection of two 8" pipelines
 - . oxyarc cutting trials
 - . in-the-wet welding trials
- The depth of 1510 feet does not constitute an absolute limit in the realm of diving. Two of the divers spent a total of twenty minutes in the water at the record depth of 501 meters, or 1644 feet.

- Comex's professional hard-hat divers have acquired a degree of competence and self-control commensurate with great depth. Even if techniques should become more and more sophisticated and inspection of work more frequent and thorough, they have confronted the hostile world of deep water and high pressure without problems.

A report written by one of the divers, Jacques VERPEAUX, who was the first diver out at 460 meters and again at 501 meters, confirms that the goal was attained.

"Dive on morning of October 18th :

Bell goes down without any problems. We are relaxed. To save time I start kitting up before we get to working level.

The back pack is very heavy and we have trouble fastening the two bottom hooks. When I am kitted up I sit down with the back pack resting on the seat to relieve me of the weight, and put on my flippers. The face mask will be put on at the last minute.

When Patrick RAUDE goes to open the door my flippers get in the way. We decide it would be better to put them on afterwards, in the future.

Once the door is open all I have to do is put my face mask on and slip into the water. Feet first, holding myself up on my arms. The back pack gets caught on the edge of the skirt and Patrick has to unhook it. I let go with my arms to go down and put my feet on the trapeze, which veers off to one side, not a very pleasant sensation when you're going out at -460 meters for the first time ! I get my balance back and feel better. Go down slowly, checking my morale as I go. Everything O.K. !

The work table is lighted 10 meters below, I only have to slide down the guide lines. I am very conscious of my respiration, which is very noisy, so that I have to hold my breath when I want to listen to the surface. This can be corrected with a great deal of self-control and I don't have any more trouble with respiration during this dive-true, I didn't make any physical effort, either. Pierre NOGUERRA on the surface seems more anxious than I am, and keeps telling me to breathe more calmly, when everything is fine ! I feel very well, very clear-headed.

I start checking the control console and hydraulic valves right away. All O.K. I ask surface to turn on the power pack. Very noisy but O.K. I position the pipe at an angle, the ram works all right. I measure the length of pipe to be cut off and attach the air bag to the Porta-tool. Then I look for the filling hose coiled on a spotlight stand. I ask surface to turn on the pressure and wait. After a moment Pierre asks me to return to the bell (a half-hour dive) to let Gérard come out.

I climb up the guide line to the bell hand over hand, asking that the bellman be instructed to haul in my umbilical without pulling me up by it.

Getting into the hatch is no problem but find it impossible to hoist myself or have myself hoisted into the bell (too heavy, no ladder or other foot holds, or hand holds either). It is decided to lift me in with the lugall, finally.

Conclusion :

The work is entirely possible both from a physical and from an intellectual point of view to work in

conditions such as those of "JANUS IV" at 460 meters' depth. With the right tools and certain modifications in some of the individual equipment, and especially, in the bell fittings, viz. :

- footholds in the hatch and going down into the water.
- rigid trapeze
- handholds to hoist oneself into the bell.
- device for hooking the back pack on the wall at the level of the diver.

Under these conditions a real worksite at 460 meters' depth seems to me to be entirely feasible..."

From the amount of time spent in the water, from the work accomplished, and from the divers' own testimony it is clear that this operation is a complete success.

It demonstrates that during the course of the three phases of "JANUS IV" Comex has solved the physiological, psychological and technological problems connected with human interventions at depths of 460/501 meters, 1510/1644 feet.

The range of direct human access to the ocean depths has been greatly extended, opening new perspectives to the offshore oil industry.



WELCOMING THE DIVERS AFTER
THE OPERATION

A P P E N D I X

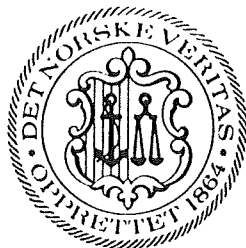

DECLARATION
=====

JANUS IV - DIVING OPERATION -
=====

We hereby certify that the diving system installed onboard the drilling vessel PETREL might from a structural strength point of view be pressurized to 43 bar. This is based upon strength evaluation dated Marseille 27.05.77, certificate for new windows NV MSL 819/77, and leakage tests at 43 bar as carried out at Marseille 12-13.10.77 (survey report dated 13.10.77).

MARSEILLE
13.10.1977
H. Ringnes
H. RINGNES.
Surveyor.

Det norske Veritas has no liability for loss or damage caused by its organs, officers, employees or others who act under assignment from the Institution, regardless of whether such person has acted intentionally or negligently and irrespective of whether the loss or damage has affected a shipowning company, a shipyard or others who have requested the Institution's assistance or any third party who without having any contractual relations with the Institution, has acted or made arrangements in reliance on decisions made or information given by or on behalf of the Institution. Nor, in cases as mentioned in the preceding paragraph, can the individual or individuals who have personally caused the loss or damage, be held liable.

ONE OF NUMEROUS MODIFICATIONS MADE ON THE
DIVING SYTEM GRACIOUSLY LENT WITH THE DRILL SHIP PETREL

JANUS IV

APPENDIX II

PRESS RELEASE N° 1 OF OCTOBER 15th, 1977

JANUS IV - DEEP SEA DIVING PHASE

The actual sea phase of operation "JANUS IV" is scheduled to start on Saturday October 15th, 1977.

This operation has been organized by COMEX, the FRENCH NAVY (GISMER, DRME), the FRENCH NATIONAL OCEANOGRAPHIC ORGANISATION (CNEXO) and the ELF-AQUITAINE Petroleum group, with COMEX acting as the Operator for the association.

In the first phase, eight divers were selected who subsequently spent eight days in a special hyperbaric complex at the COMEX hyperbaric experimental center, during the second dress rehearsal phase, at a living depth pressurized to the equivalent of 400 meters' depth (1310 feet).

From this "storage depth" actual work assignments were carried out in a pool pressurized to the equivalents of 430 m, 445 m, 460 m, and 480 m depths- (1410 feet, 1460 feet, 1510 feet, 1575 feet).

During phase III of operations 'JANUS IV' a pipeline connection will be made beneath the sea at a depth of 460 meters/ 1510 feet.

Diver compression is scheduled to begin the morning of Saturday, October 15th, to be followed by three days of diving and work on October 17, 18 and 19 to 460 meters.

The operation will be carried out from the dynamically positioned ship 'PETREL' which has generously been put at the disposition of the project by the ELF-AQUITAINE group.

The site chosen for the operation lies between the ILE DU LEVANT and CAP BENAT in the MEDITERRANEAN SEA.

This operation will set a world precedent of considerable significance. A "de facto" worldwide "healthy competition" has been under way for some time in the area of human diving to ever greater depths, with the leaders (national navies and private firms) situated essentially in the UNITED STATES, GREAT BRITAIN and FRANCE.

The 460 meter depth alters the scale of this competition. For at present, apart from a few isolated worksites of a relatively sensational nature here and there, the great majority of subsea work undertaken for the offshore oil industry falls within the 100-200 meter range (i.e 330-feet).

By acceding to the record depth of 460 meters / 1510 feet, the operator of "JANUS IV", COMEX, with its associates CNEXO and the FRENCH NAVY, will effectively double the sea depth at which human beings can work at ambient pressure.

This will most certainly have economic and technical repercussions in the not too distant future in the search for the new oil fields which all of the nations of the world need so greatly.

PRESS RELEASE N° 2 OF OCTOBER 19th, 1977

The FRENCH NATIONAL OCEANOGRAPHIC ORGANISATION (CNEXO), COMEX and the FRENCH NAVY (GISMER - DRME) started the "JANUS IV" operation on October 15th 1977.

COMEX organised the running of this operator which enabled real in-water interventions at 460 meters (1510 feet).

A thirty-hour compression on October 15th and 16th brought the six preselected volunteer divers to a pressure corresponding to a depth of 430 meters (1410'), their living depth for the duration of the diving program.

The actual sea dives, which had been scheduled to start on October 17th, were delayed 24 hours because of certain technical problems.

On October 18th, therefore, the first sea dives were made to a depth of 460 meters (1510').

During the first dive, lasting 2 hours 55 minutes, Patrick RAUDE of COMEX served as bellman while Jacques VERPEAUX (COMEX) followed by Chief Petty Officer Gérard VIAL (GISMER) spent 35 minutes and 13 minutes, respectively, on the underwater site.

The second dive, which took place the same day, lasted 2 hours and 30 minutes, Philippe JEANTOT (COMEX) served as bellman while Louis SCHNEIDER (COMEX) and Senior Chief Petty Officer Emile SEVELLEC (GISMER) locked out on site for 45 minutes and 17 minutes, respectively.

These relatively short dives permitted the divers to become accustomed to the unfamiliar conditions in which they would be

working.

On October 19th the divers attacked the work program planned for this final phase of "JANUS IV".

The third dive in the series lasted 5 hrs. 08 min. with Patrick RAUDE (COMEX) working on site 2 hrs. 21 mins. and Chief Petty Officer Gérard VIAL (GISMER) 1 hr. under the surveillance of Jacques VERPEAUX (COMEX), bellman. The fourth dive began the same day at 18h00. with Philippe JEANTOT (COMEX) and Senior Chief Petty Officer Emile SEVELLEC (GISMER) on site for 35 minutes and 55 minutes, respectively.

The six divers are in excellent physical condition after these dives and will continue the diving program tomorrow.

Operation "JANUS IV" is taking place from the dynamically positioned ship "PETREL", which was graciously lent to the Project by its charterer, ELF-AQUITAINE.

Two small submersibles, the FRENCH NAVY'S "GRIFFON" operating from the BIESM Triton and C.N.E.X.O's "Cyana" operating from the N/O SUR0IT are participating in the operation as site reconnaissance and monitoring vehicles. The Griffon remains on standby near the site during dives as a safety measure.

"JANUS IV" has thus already achieved its primary goal : to prove that human beings are capable of going to and functioning at a depth of 460 meters beneath the surface of the ocean.

PRESS RELEASE N° 3 OF OCTOBER 20th,1977

Today, October 20th, between 15H20 and 16H20, two divers from operation "JANUS IV" reached the depth of 501 metres during two 10 minute dives.

The divers were Jacques VERPEAUX of COMEX and Chief Petty Officer Gérard VIAL of the FRENCH NAVY, Patrick RAUDE of COMEX was the bellman.

This was, of course, an operation in the open seas constituting far and away a new world diving record. The previous record is held by the U.S NAVY, whose divers went to a depth of 349 metres in 1975.

Operation "JANUS IV" is still in progress.

During the next dive the second team will continue the pipeline connection job started Tuesday A.M. October 18th at 460 metres.

At present, the six divers total seven hour's bottom time at this depth.

PRESS RELEASE N° 4 OF OCTOBER 21th,1977

The sixth and last dive of operation "JANUS IV" was completed at 0.15.a.m. on October 21.st

The 2 man diving teams were composed of Patrick RAUDE (COMEX), Jacques VERPEAUX (COMEX), Chief Petty Officer Gérard VIAL (of the FRENCH NAVY) and of Philippe JEANTOT (COMEX), Louis SCHENIDER (COMEX), Senior Chief Petty Officer Emile SEVELLEC (FRENCH NAVY).

During these six dives, which took place between 10.42.a.m. on October 18 and 0.15.a.m. on October 21, 10 hours of work were performed on the underwater site at 1508 feet, and the depth of 1644 feet was attained during two 10 minute dives.

Operation "JANUS IV" is therefore a complete success. Its main goal, proving that man is capable of working efficiently at a depth of 1508 feet, has thus been achieved. The scheduled work program was carried out in conditions which were fully operational. This work consisted of the following tasks :

- . a mechanical connection between two 8" diameter pipelines by COMECTOR,
- . pipe cutting,
- . welding

The range accessible to human beings for underwater operations has been greatly extended, thus opening up new horizons to the offshore industry.



PRESIDENT H.G DELAUZE AND PROJECT MANAGER J. CORBIER WITH
THE DIVERS AT THE END OF OPERATION "JANUS IV" :
(from left to right)

Patrick RAUDE,
Louis SCHNEIDER,
Philippe JEANTOT,
Emile SEVELLEC,
Gérard VIAL,
Jacques VERPEAUX.

27 JAN. 1978